



ADVANCED MANUAL

HF/50 MHz TRANSCEIVER IC-7760

This manual describes instructions for advanced features and instructions.
See the BASIC MANUAL that come with the transceiver for precautions and basic operations.

- 1 ADVANCED CONNECTIONS
- 2 ADVANCED OPERATIONS
- 3 SCOPE OPERATION (ADVANCED)
- 4 SD CARD/USB FLASH DRIVE (ADVANCED)
- 5 VOICE RECORDER FUNCTIONS
- 6 VOICE TX MEMORY FUNCTION
- 7 MEMORY OPERATION
- 8 SCANS
- 9 ANTENNA TUNER OPERATION (ADVANCED)
- 10 CLOCK AND TIMERS (ADVANCED)
- 11 OTHER FUNCTIONS
- 12 MAINTENANCE (ADVANCED)
- 13 UPDATING THE FIRMWARE

INTRODUCTION

Thank you for choosing this Icom product. This product is designed and built with Icom's state of the art technology and craftsmanship. With proper care, this product should provide you with years of trouble-free operation.

ABOUT THE MANUALS

You can use the following manuals to understand and operate this transceiver.

(As of October 2024)

| |
|---|
| <p>TIP: You can download each manual and guide from the Icom website. https://www.icomjapan.com/support/ Enter "IC-7760" into the Search box in the site.</p> |
|---|

- **Basic manual (Comes with the transceiver)**
Instructions for basic operations.
- **Advanced manual (This manual)**
Instructions for advanced operations in English.
- **CI-V Reference guide (PDF type)**
Describes the control commands used in remote control operation (serial communication with CI-V) in English.
- **I/Q Port Reference guide (PDF type)**
Describes the I/Q data and control commands used in remote control operation in English.
- **Information for the HSDR application (PDF type)**
Describes how to use the IC-7760 with the HSDR application in English.

For Reference

- **HAM Radio Terms (PDF type)**
A glossary of HAM radio terms in English.

TRADEMARKS

Icom and the Icom logo are registered trademarks of Icom Incorporated (Japan) in Japan, the United States, the United Kingdom, Germany, France, Spain, Russia, Australia, New Zealand, and/or other countries.

Adobe, Acrobat, and Reader are either registered trademarks or trademarks of Adobe Systems Incorporated in the United States and/or other countries.

Microsoft and Windows are trademarks of the Microsoft group of companies.

All other products or brands are registered trademarks or trademarks of their respective holders.

FUNCTIONS AND FEATURES OF ADOBE® ACROBAT® READER®

The following functions and features can be used with Adobe Acrobat Reader.

• **Keyword search**

Click “Find” (Ctrl+F) or “Advanced Search” (Shift+Ctrl+F) in the Edit menu to open the search screen. This is convenient when searching for a particular word or phrase in this manual.

① The menu screen may differ, depending on the Adobe Acrobat Reader version.

Click to open the find or search screen or advanced search screen.

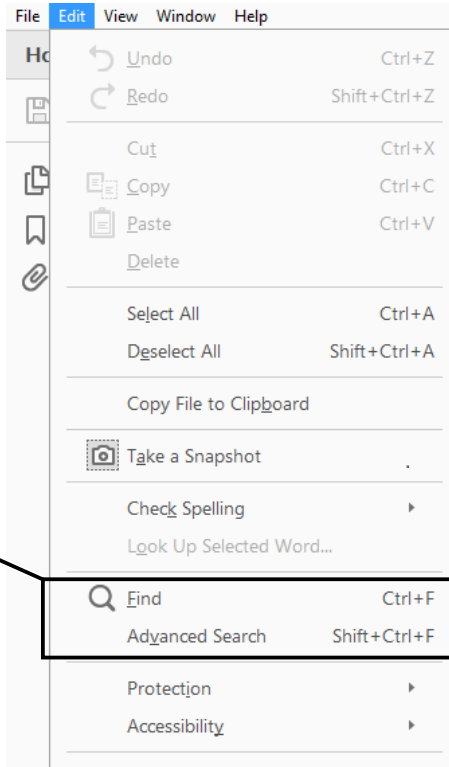

• **Find screen**

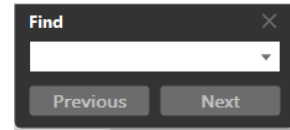

• **Advanced search screen**

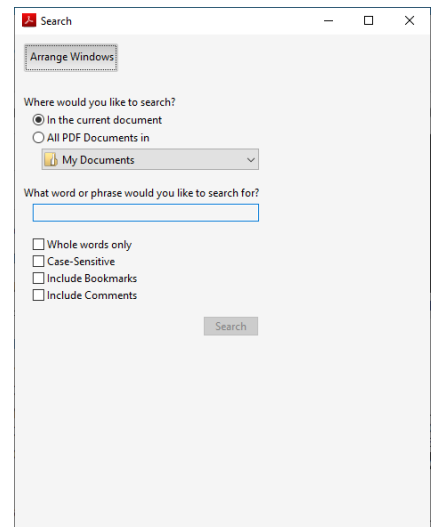

• **Printing out the desired pages.**

Click “Print” in File menu, and then select the paper size and page numbers you want to print.

① The printing setup may differ, depending on the printer. Refer to your printer’s instruction manual for details.
① Select the “A4” size to print out the page in the original manual size.

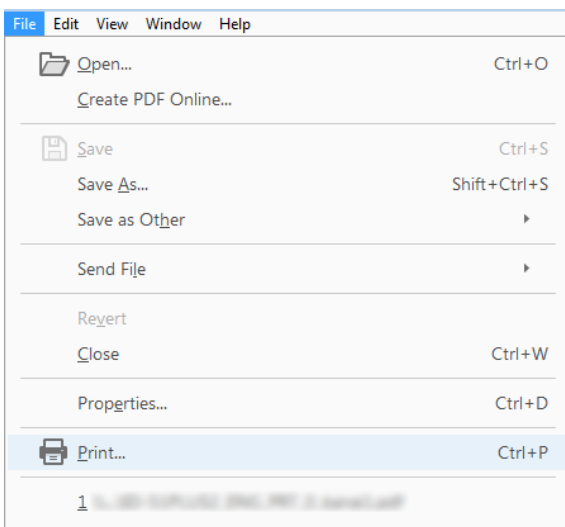

• **Read Out Loud feature.**

The Read Out Loud feature reads aloud the text in this PDF.

Refer to the Adobe Acrobat Reader Help for the details.

(This feature may not be usable, depending on your PC environment, including the operating system.)

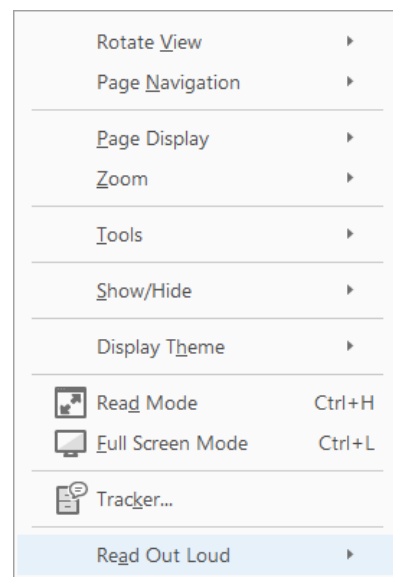

① The screen may differ, depending on the Adobe Acrobat Reader version.

KEYBOARD ENTERING AND EDITING

Keyboard types:

You can select the Full Keyboard or the Tenkey pad in "Screen Keyboard Type" on the FUNCTION screen.

MENU » **SET > Function > Screen Keyboard Type**

① You can also temporarily switch the type in the QUICK MENU screen by pushing **QUICK**.

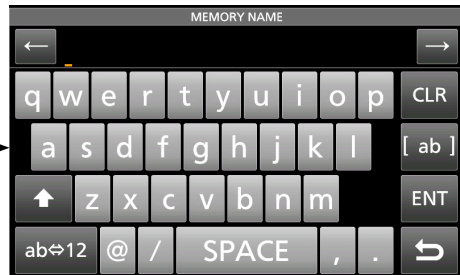
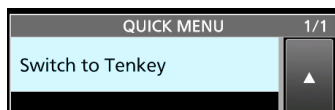
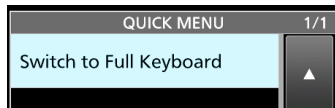

① You can select the full keyboard layout in "Screen Full Keyboard Layout" on the FUNCTION screen.

MENU » **SET > Function > Screen Full Keyboard Layout**

Entering and editing:

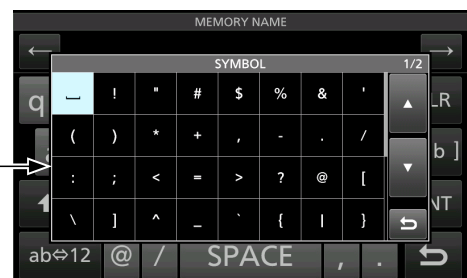
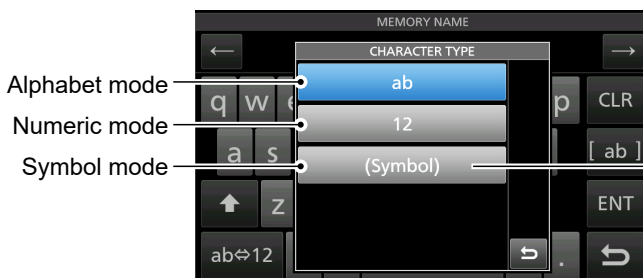
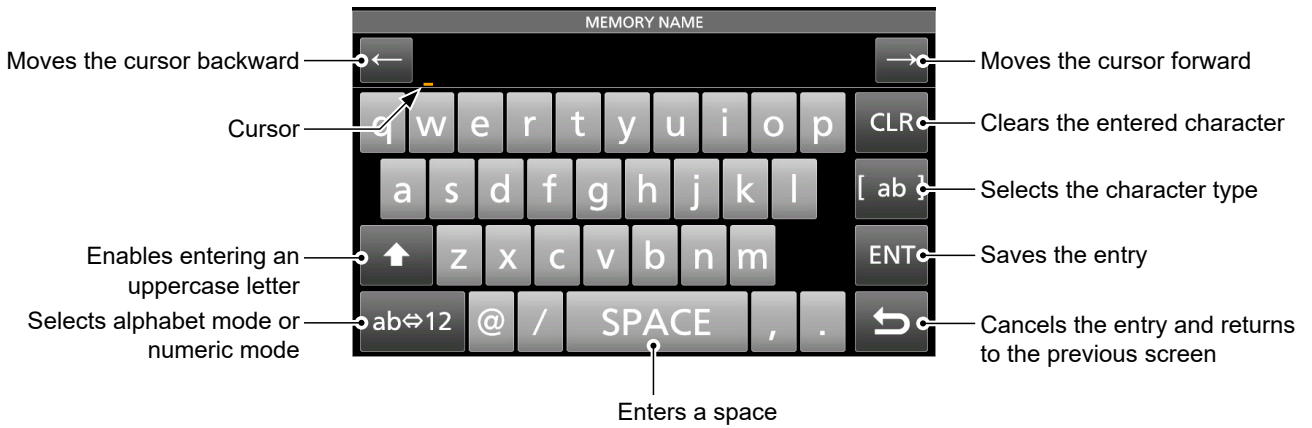

INTRODUCTION

USABLE CHARACTERS

You can enter and edit the items in the following table.

| Menu | Item | Selectable characters | Maximum characters |
|--------|---------------------------|---|--------------------|
| SET | Network Name | A to Z, 0 to 9, ! " # \$ % & () + , - . ; = @ [] ^ | 15 |
| | Network User 1/2 ID | [AB] [ab] [12] [!"#] | 16 |
| | Network User 1/2 Password | • Illegal characters: \ (space) | 16* |
| | Network Radio Name | | 16 |
| | My Call | A to Z, 0 to 9, / @ - . | 10 |
| | NTP Server Address | A to Z, a to z, 0 to 9, - . | 64 |
| | CLOCK2 NAME | [AB] [ab] [12] [!"#] | 3 |
| | Save Setting | [AB] [ab] [12] [!"#] • Illegal characters: / : ; * < > \ | 23 |
| SCAN | NAME | [AB] [ab] [12] [!"#] | 16 |
| KEYER | Keyer Memory | A to Z, 0 to 9, (space), / ? ^ . , @ • " * " (asterisk) has its own unique use. | 70 |
| DECODE | RTTY Memory | A to Z, 0 to 9, (space), ! \$ & ? " ' - / . , ; ; () _ • " * " (asterisk) has its own unique use. | 70 |
| | PSK Memory | [AB] [ab] [12] [!"#] | 70 |
| VOICE | VOICE TX RECORD | [AB] [ab] [12] [!"#] | 16 |
| MEMORY | MEMORY NAME | [AB] [ab] [12] [!"#] | 10 |
| PRESET | Preset Name | [AB] [ab] [12] [!"#] | 16 |

[AB]: A to Z, (space)

[ab]: a to z, (space)

[12]: 0 to 9, (space)

[!"#]: ! " # \$ % & ' () * + , - . / : ; < = > ? @ [\] ^ _ ` { | } ~ (space)

* Minimum of 8 characters

Section 1

ADVANCED CONNECTIONS

| | |
|---|-----|
| 137 kHz band operation (European version only) | 1-2 |
| Connecting the RC-28 | 1-3 |
| ◇ Using the RC-28 | 1-3 |
| FSK, AFSK, and PSK connections | 1-4 |
| Connecting the controller and RF deck through a network | 1-5 |
| When using 2 or more IC-7760 | 1-5 |

137 kHz band operation (European version only)

You can also operate between 135.7 and 137.8 kHz in the CW mode.

The RF signal from [X-VERTER] is used for this operation.

- ① The output of [X-VERTER] is -20 dBm, so a linear amplifier of up to 1 watt may be required.
- ① See the connection illustration to the right.

- Be sure to turn OFF the transceiver and the amplifier when connecting them.
- To enable the [X-VERTER] connector, set "Transverter Function" to ON, or connect a voltage of $2 \sim 15$ V DC to [ACC 2 (6: TRV)] (★).
MENU » SET > Function > **Transverter Function**
- Set the offset frequency in "Transverter Offset" to "0.000 MHz" to match the transceiver's operating frequency with the transmitting frequency.
MENU » SET > Function > **Transverter Offset**
- The antenna cannot be selected, and the internal antenna tuner cannot be used while the Transverter function is turned ON.

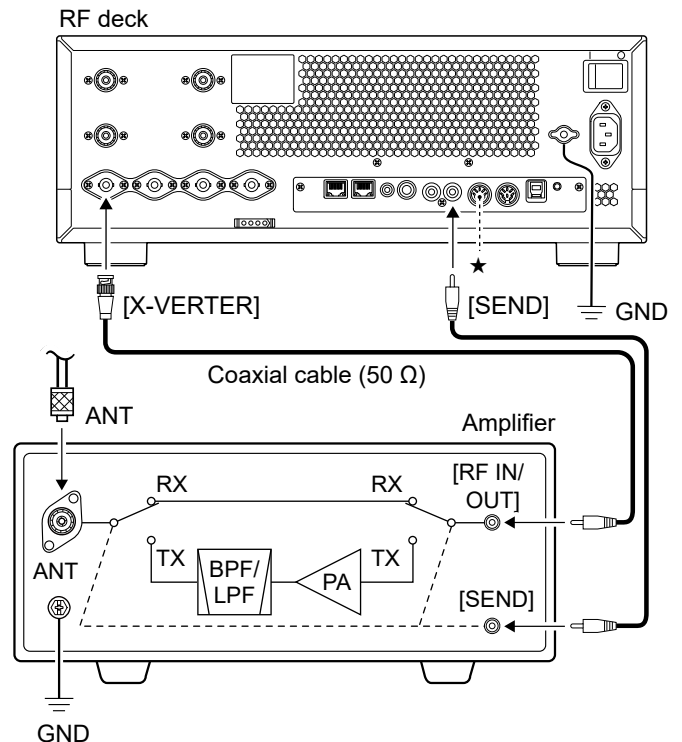

Connecting the RC-28

The optional RC-28 REMOTE ENCODER can be used as a sub dial.

NOTE:

- See the RC-28's manual to use the RC-28 with the RS-BA1 IP REMOTE CONTROL SOFTWARE.
- Operation using the RC-28 with other than the USB cable supplied with the RC-28, or connecting it through a USB hub, is not guaranteed by Icom.

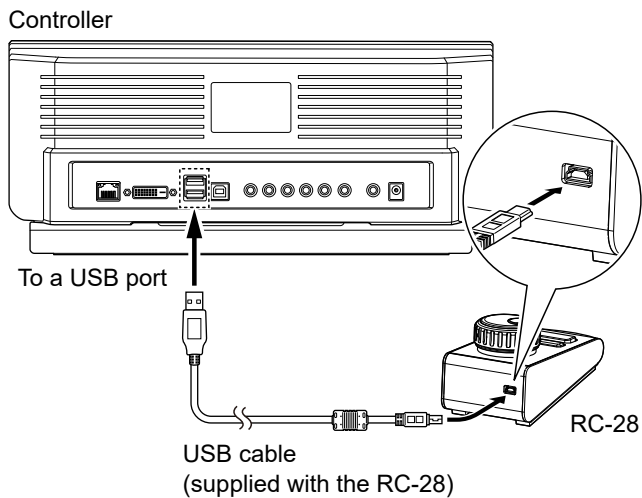

◇ Using the RC-28

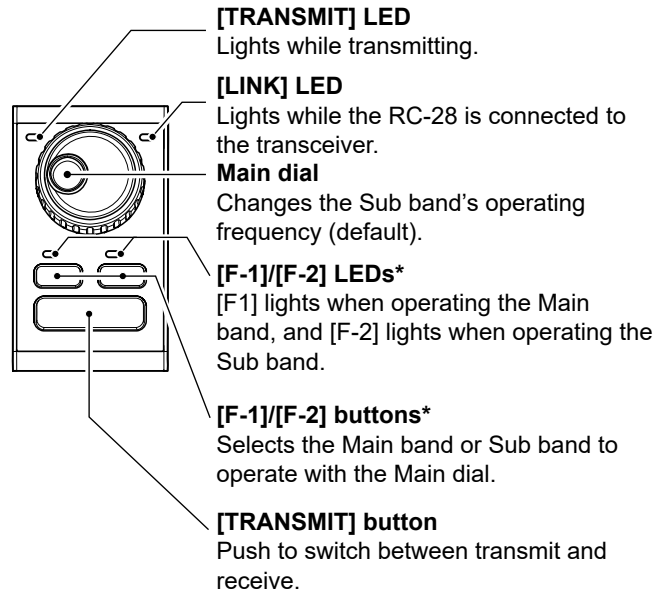

* The [F-1] and [F-2] buttons or keys are disabled when "USB Dial Select" is set to "Only SUB."

- ① Setting the "USB Dial Select" to "MAIN/SUB" enables you to operate both the Main band and the Sub band, using the RC-28.

MENU » SET > Connectors > USB DIAL >
USB DIAL Select

1 ADVANCED CONNECTIONS

FSK, AFSK, and PSK connections

The transceiver has a mode key for RTTY and PSK. You can use a PC and an application software to operate SSTV, RTTY, AFSK, PSK31, JT65, or FT8 using a USB cable.

See the interface circuit diagram below for details.

Refer to the software application's instruction manual for setup details.

(Icom does not guarantee the performance of the application software, PC, network device, or network settings.)

When using the USB port

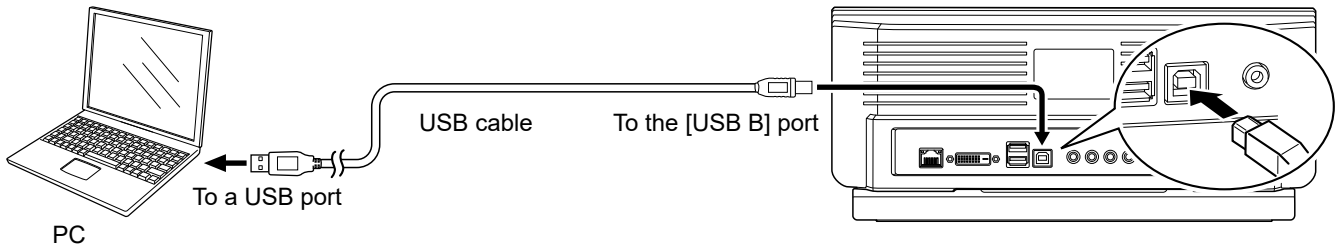

TIP:

- To operate RTTY through your PC's USB port, set the following item.

MENU » **SET > Connectors > USB SEND/Keying**

- Download the USB driver and the installation guide from the Icom website.
<https://www.icomjapan.com/support/>

When using the [ACC 1] socket, [MIC] connector, [SEND] jack, [LINE-IN] jack, and [LINE-OUT] jack

- Connecting to [ACC 1]

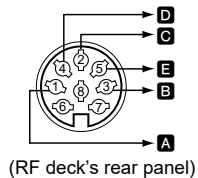

- Connecting to [MIC]

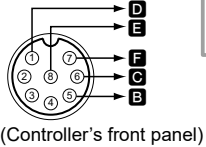

NOTE: You cannot operate FSK RTTY when you connect the circuit to the microphone connector.

- Connecting to [SEND]

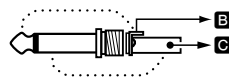

- Connecting to [LINE IN]

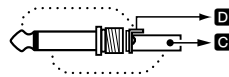

- Connecting to [LINE OUT]

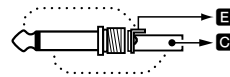

Interface circuit example for digital modes (User supplied)

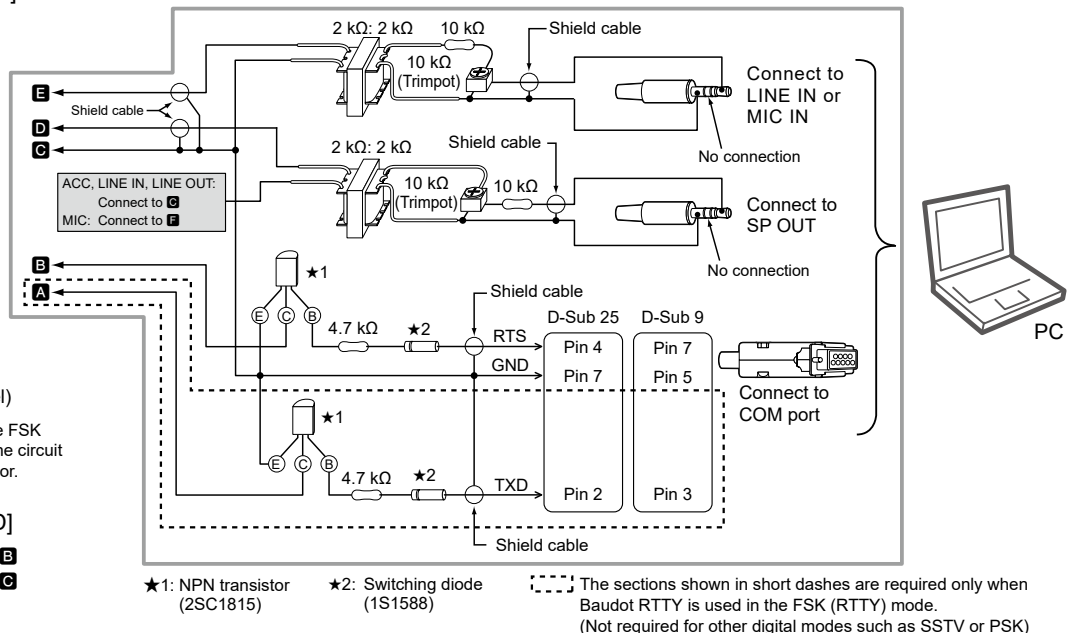

① See the Basic manual for details on each connector.

Connecting the controller and RF deck through a network

After the controller and RF deck are paired, you can connect the controller and RF deck through a network as shown below.

NOTE: Use networking devices and ethernet cables that are compatible with Gigabit Ethernet.

Operation cannot be guaranteed if:

- Connecting through a wireless LAN network.
- Using a networking device or ethernet cable that is compatible only with Fast Ethernet or prior.

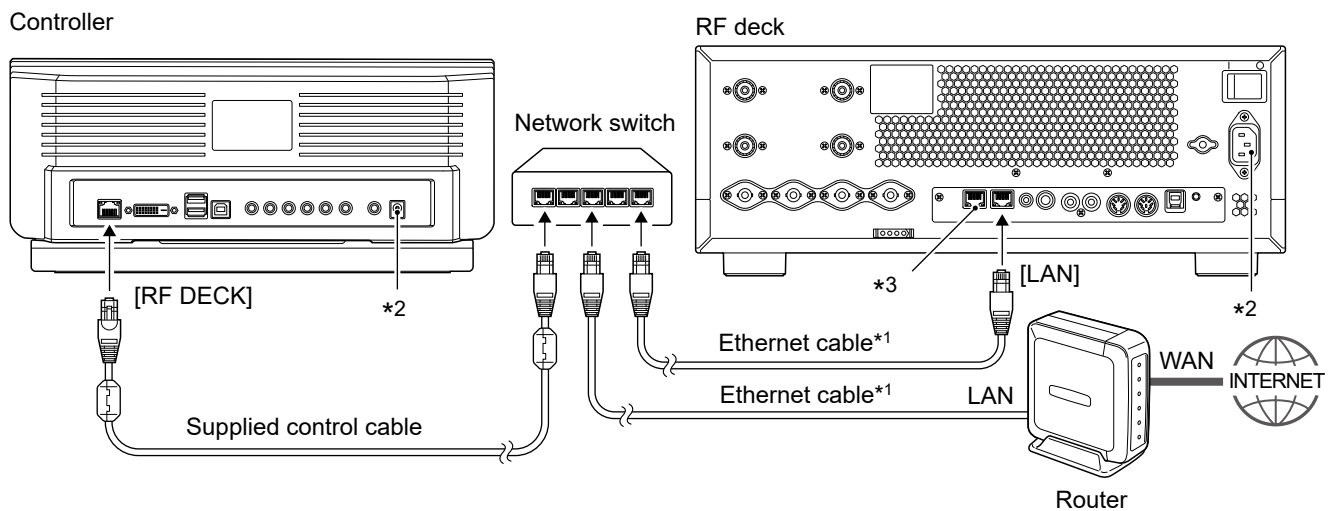

*1 User supplied

*2 See the Basic manual for about connecting the power cables and grounding.

*3 **DO NOT** connect [CONTROLLER] to a networking device.

① When a DHCP server is not in a network, set "DHCP" to "OFF," and then set "IP Address (LAN)," "IP Address (Controller)," and "IP Address (RF Deck)."

When using 2 or more IC-7760

Be careful the following when 2 or more IC-7760 (controller and RF deck) are operated.

- The [CONTROLLER] port on the RF deck can be used only for connecting a controller.
DO NOT connect 2 or more controllers or other devices to the RF deck's [CONTROLLER] port.
- Before using the transceiver for the first time, or after performing an All reset, directly connect the controller and the RF deck with a supplied control cable to pair them.
- When you want to operate an RF deck from 2 controllers, pair the RF deck and each controller.
- Even when an RF deck is paired with 2 or more controllers, you can use only one controller to operate the RF deck simultaneously.

A controller that is turned ON last has the priority of connecting to the RF deck. In this case, the controller first connected to the RF deck displays a dialog for 5 seconds, and then that controller will automatically be turned OFF.

① When "Power OFF Setting (for Remote Control)" is set to "Standby/Shutdown," the controller will automatically go into the Standby mode.

- If you use a one-to-one controller and RF deck but 2 or more controllers and RF decks are in the same network, **DO NOT** pair your RF deck with other controllers.

① If the RF deck is paired with another controller, the controller that is turned ON last is connected to the RF deck.

① To clear the pairing information, save the setting data onto an SD card or USB flash drive, do an All reset, and then loading the saved data files.

| | |
|--|------|
| Band Edge Beep | 2-2 |
| ◇ Band Edge Beep | 2-2 |
| ◇ Entering a Band Edge | 2-2 |
| Adjusting the Drive Gain level | 2-5 |
| IP Plus function..... | 2-5 |
| Tracking function | 2-6 |
| VOX function | 2-7 |
| ◇ Adjusting the VOX function | 2-7 |
| ΔTX function..... | 2-8 |
| ◇ ΔTX monitor function..... | 2-8 |
| Operating CW (ADVANCED)..... | 2-8 |
| ◇ About the CW Reverse mode..... | 2-8 |
| ◇ Using the Memory Keyer function (KEYER)..... | 2-9 |
| ◇ Keyer memory edit menu (EDIT)..... | 2-10 |
| ◇ Contest number menu (001 SET) | 2-11 |
| ◇ Keyer Set menu (CW-KEY SET)..... | 2-12 |
| Operating RTTY (FSK)..... | 2-13 |
| ◇ Displaying the RTTY DECODE screen | 2-13 |
| ◇ Using the RTTY DECODE screen..... | 2-13 |
| ◇ RTTY decoding..... | 2-14 |
| ◇ Twin Peak Filter (TPF)..... | 2-14 |
| ◇ Using the RTTY Memory function | 2-14 |
| ◇ Setting the RTTY Automatic TX/RX..... | 2-16 |
| ◇ Editing an RTTY memory | 2-17 |
| ◇ Contest number menu (001 SET) | 2-18 |
| ◇ Turning ON the RTTY log..... | 2-19 |
| ◇ RTTY DECODE LOG SET screen | 2-19 |
| ◇ Viewing the RTTY log contents | 2-20 |
| ◇ RTTY DECODE SET screen | 2-20 |
| Operating PSK..... | 2-22 |
| ◇ Displaying the PSK DECODE screen | 2-22 |
| ◇ Using the PSK DECODE screen..... | 2-22 |
| ◇ PSK decoding..... | 2-23 |
| ◇ AFC/NET function..... | 2-23 |
| ◇ Using the PSK Memory function | 2-24 |
| ◇ Setting the PSK Automatic TX/RX..... | 2-25 |
| ◇ Editing a PSK memory | 2-26 |
| ◇ Turning ON the PSK log..... | 2-27 |
| ◇ PSK DECODE LOG SET screen..... | 2-27 |
| ◇ Viewing the PSK log contents | 2-28 |
| ◇ PSK DECODE SET screen | 2-28 |
| FM repeater operation | 2-30 |
| ◇ Checking the repeater input signal..... | 2-30 |
| ◇ Setting the repeater tone frequency | 2-31 |
| Tone squelch operation | 2-32 |
| Data communication..... | 2-33 |
| Transverter operation | 2-33 |
| ◇ Transverter setting example | 2-33 |
| DPD function | 2-34 |
| ◇ How to use the DPD function | 2-34 |
| ◇ Before using the DPD function | 2-34 |
| ◇ About the DPD ADJUSTMENT screen..... | 2-35 |
| ◇ DPD single adjustment..... | 2-36 |
| ◇ DPD linked adjustment..... | 2-37 |
| ◇ Clearing the DPD adjustment value | 2-38 |
| ◇ Turning the DPD function ON or OFF | 2-39 |
| ◇ About the DPD adjustment frequency range..... | 2-39 |
| About the 5 MHz frequency band operation (For USA version) | 2-40 |

Band Edge Beep

◆ Band Edge Beep

You will hear a Band Edge Beep and **TX** (with a dotted border) will be displayed when you tune into or out of an amateur band's frequency range.

① You can change the Band Edge Beep settings in the following menu.

MENU » **SET > Function > Band Edge Beep**

① If "Beep Level" is set to "0%," no beep sounds.

MENU » **SET > Function > Beep Level**

◆ Entering a Band Edge

When "ON (User)" or "ON (User) & TX Limit" is selected on the "Band Edge Beep" screen, you can enter a total of 30 band edge frequency pairs.

① Information

- Initially, all Ham band frequencies are entered. Therefore, you must first edit or delete them, and then insert a new line to enter a new band edge.
- You cannot enter an overlapping frequency, or a frequency that is out of the preset Ham band frequencies.
- The default setting may differ, depending on the transceiver version.
- Band edges are entered from the lower frequency first.

1. Open the "Band Edge Beep" screen.

MENU » **SET > Function > Band Edge Beep**

2. Touch "ON (User)" or "ON (User) & TX Limit."

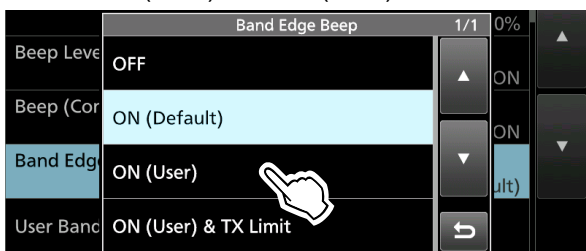

① If you set "ON (User) & TX Limit," you can limit transmission to within the entered frequency range.

3. Touch "User Band Edge."

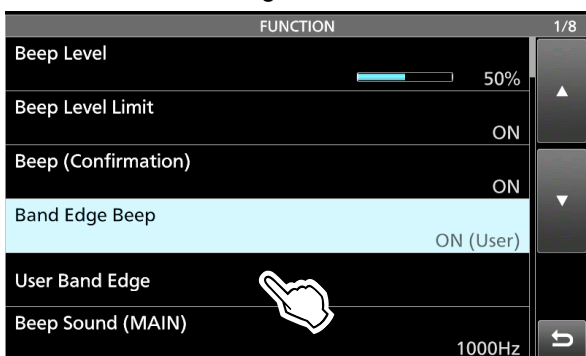

- Opens the "User Band Edge" screen.

Editing a Band Edge

You can edit a band edge entered as a default, or change the band edge frequencies.

1. Open the "User Band Edge" screen.
2. Touch the band edge you want to edit.
(Example: 6: 14.000.000 – 14.350.000 MHz)

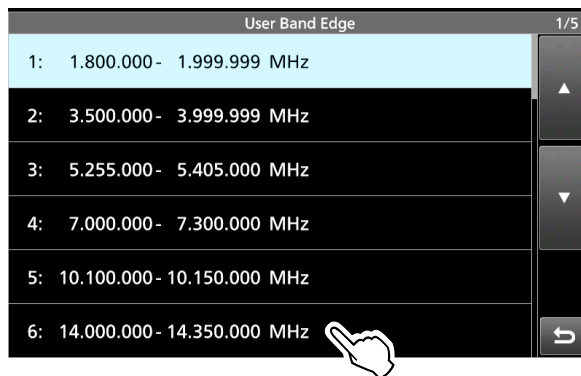

3. Edit the lower band edge frequency, then touch [ENT]. (Example: 14.1)
Entry example: [.] [1] [ENT]



4. Edit the upper band edge frequency, then touch [ENT]. (Example: 14.25)
Entry example: [.] [2] [5] [ENT]



- The edited band edge is saved, and returns to the previous screen.

TIP: You can also edit the frequency by rotating **MAIN DIAL** or **MULTI**.

2 ADVANCED OPERATIONS

Band Edge Beep

◇ Band Edge Beep

Deleting a Band Edge

You can delete band edges you no longer need.

1. Open the “User Band Edge” screen.
2. Touch the desired band edge to delete for 1 second.
(Example: 11: 50.000.000 – 54.000.000 MHz)

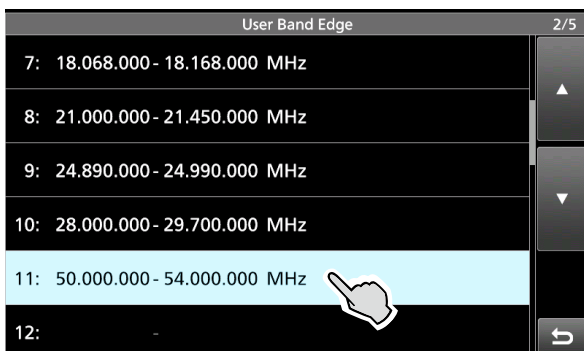

3. Touch “Delete.”

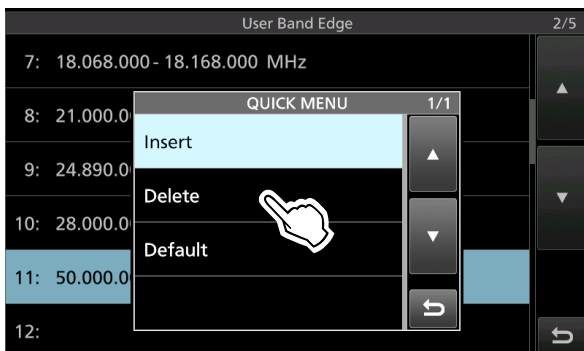

- The selected band edge is deleted, and returns to the previous screen.

Entering a new Band Edge

You can enter new Band Edge frequencies into a blank band edge line.

1. Open the “User Band Edge” screen.
2. Touch a blank band. (Example: 11)

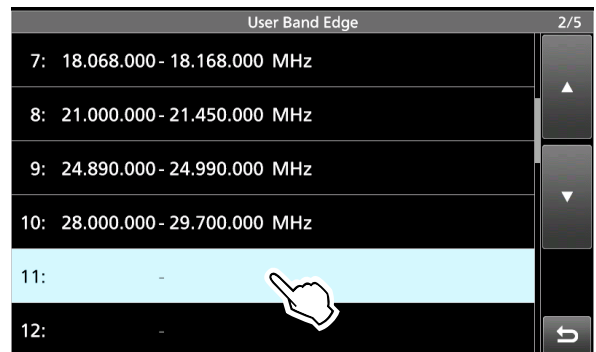

3. Enter the lower band edge frequency, then touch [ENT]. (Example: 51.15)
Entry example: [5] [1] [.] [1] [5] [ENT]



4. Enter the upper band edge frequency, then touch [ENT]. (Example: 51.75)
Entry example: [.] [7] [5] [ENT]



- The entered band edge is saved, and returns to the previous screen.

2 ADVANCED OPERATIONS

Band Edge Beep

◇ Band Edge Beep

Inserting a Band Edge

You can insert a new Band Edge line, and enter new band frequencies, between two entered band edges.

1. Open the “User Band Edge” screen.
2. Touch the band edge you want to insert a new band edge above, for 1 second.
(Example: 1: 3.500.000 – 3.999.999 MHz)

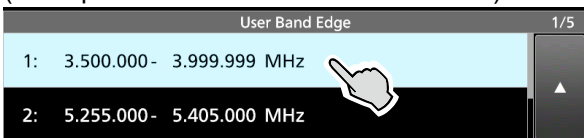

① The new band edge will be inserted above the selected band edge.

3. Touch “Insert.”

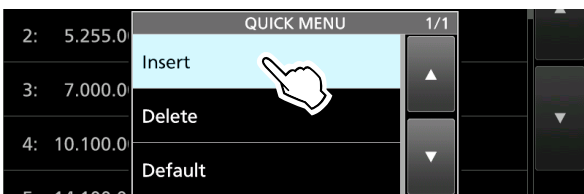

4. Enter the lower band edge frequency then touch [ENT]. (Example: 1.85)
Entry example: [1] [.] [8] [5] [ENT]

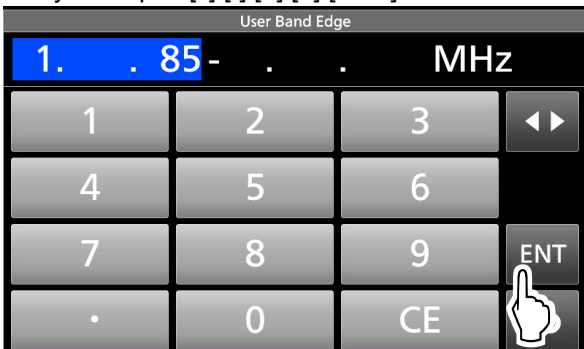

5. Enter the upper band edge frequency, then touch [ENT]. (Example: 1.95)
Entry example: [.] [9] [5] [ENT]



- The entered band edge is saved, and returns to the previous screen.

Resetting all band edges to their defaults

The steps below will reset all the band edges to their initial settings. All entered settings will be deleted.

1. Open the “User Band Edge” screen.
2. Touch any band edge for 1 second.

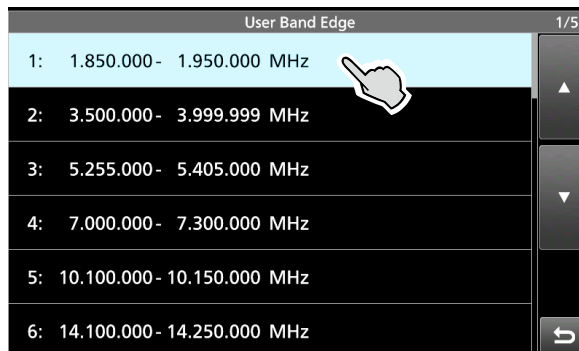

3. Touch “Default.”

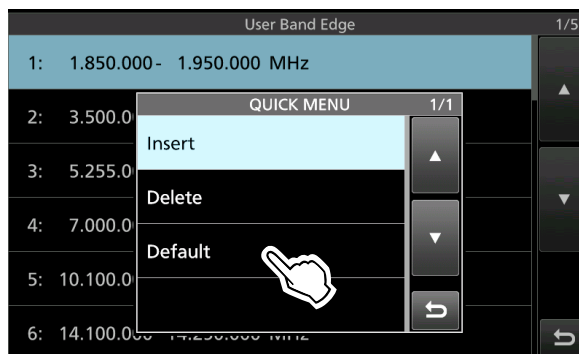

4. Touch [YES].

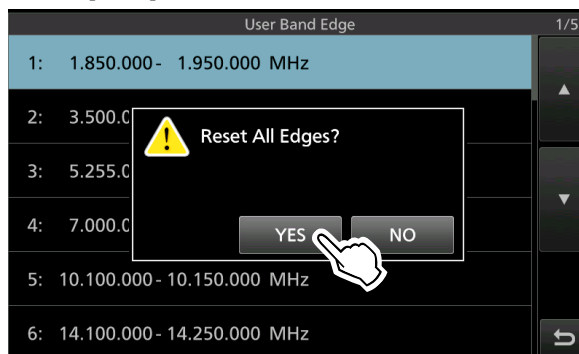

- All the band edges reset to the initial settings.

Adjusting the Drive Gain level

Adjust the transmitter level at the driver stage. This reduces distortion in the transmitting signal.

① This function can be used in all modes, except with the DPD function ON, or in the SSB mode with the Speech Compressor OFF.

1. Touch the meter, and then touch [ALC] to display the ALC meter.

ALC meter



2. Push **QUICK**.
3. Touch "Drive Gain."



4. Hold down [PTT] (or push **TRANSMIT**).
 - The TX/RX indicator lights red, and **TX** is displayed.
5. Rotate **MULTI** to adjust the Drive Gain level.



① Adjust until the meter reading swings between 30 to 50% of the ALC scale, when speaking into the microphone at your normal voice level or keying a CW key.

6. Release [PTT] (or push **TRANSMIT** again).
 - Returns to receive.

IP Plus function

The IP Plus function improves the Intermodulation Distortion (IMD) quality by optimizing the direct sampling system performance.

This function optimizes the Analog/Digital Converter (ADC) against distortion when you receive a strong input signal. It also improves the Third-order Intercept Point (IP3) while minimizing the reduction of the receiver sensitivity.

- Touch [IP+] on the Multi-function key group to turn the IP Plus function ON or OFF.
 - ON: Prioritizes the IP quality.
 - OFF: Prioritizes the receive sensitivity.



2 ADVANCED OPERATIONS

Tracking function

While in the Dualwatch operation, and when different antennas are set to the Main and Sub bands, using this function enables you to hear which antenna has better reception.

1. Push **FUNCTION**.
 - Opens the FUNCTION screen.
2. Touch [TRACKING] for 1 second.



- The selected band's indicator blinks in blue.
3. Touch the frequency readout of the band you want to set the frequency.
 4. Change the selected band's operating frequency and mode.
 - ① For example, when you change the Main band's operating frequency and mode, the Sub band's operating frequency and mode are synchronized with the Main band's.
 - ① When using the RC-28, if the offset frequency is set between the Main band and the Sub band, the frequency changes with the offset amount when rotating **MAIN DIAL**.
 5. To turn OFF the Tracking function, touch [TRACKING] on the FUNCTION screen.

NOTE: The Tracking function will be canceled when:

- Starting a scan.
- Changing the operating band, or directly entering the operating frequency on the Sub band.
- Changing from the Memory mode and the VFO mode, vice versa, and so on.

VOX function

SSB, AM, and FM modes

The Voice-Operated Transmission (VOX) function switches between transmit and receive with your voice. This function enables hands-free operation.

- Push **VOX/BK-IN** to turn the VOX function ON or OFF.
 - The “VOX” icon is displayed, and the VOX indicator on **VOX/BK-IN** lights.
- ① You can also turn the VOX function ON or OFF on the FUNCTION screen.

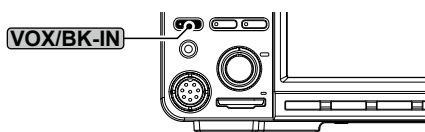

The VOX function is ON.



◇ Adjusting the VOX function

Before using the VOX function, adjust the following items.

- VOX GAIN
- ANTI VOX
- DELAY
- VOICE DELAY

1. Hold down **VOX/BK-IN** for 1 second.
2. Touch the item to adjust. (Example: ANTI VOX)



3. Rotate **MULTI** to adjust the item.
 - ① Touching VOICE DELAY selects “SHORT,” “MID,” “LONG,” or “OFF.”
4. To close the VOX menu, push **MULTI**.

VOX GAIN (Default: 50%)

Adjusts the transmit/receive switching threshold level to between 0% and 100% for VOX operation. Higher values make the VOX function more sensitive to your voice.

ANTI VOX (Default: 50%)

Adjusts the ANTI VOX level to between 0% and 100% to prevent unwanted VOX activation from the speaker or other sounds. Higher values make the VOX function less sensitive.

DELAY (Default: 0.2s)

Adjusts the DELAY to between 0 and 2.0 seconds. Set for a convenient interval for normal pauses in a speech before returning to receive.

VOICE DELAY (Default: OFF)

Sets the VOICE DELAY to prevent cutting off your voice when switching to transmit.

- Select “SHORT,” “MID,” “LONG,” or OFF.

2 ADVANCED OPERATIONS

ΔTX function

The ΔTX function shifts your transmit frequency up to ±9.99 kHz without shifting the displayed frequency.

- Push **ΔTX**.
 - The ΔTX function turns ON.
 - While using the Fine Tuning function (Basic manual), the ΔTX frequency is displayed in 4 digits, instead of 3.
 - Pushing **ΔTX** again turns OFF the ΔTX function.



ΔTX frequency (3 digits)

- Rotate **RIT/ΔTX** to set the ΔTX frequency to match the received station's frequency, up to ±9.99 kHz.
 - You can reset the ΔTX frequency to "0.00" by holding down **CLEAR** for 1 second.
- After communicating, push **ΔTX** to turn OFF the ΔTX function.

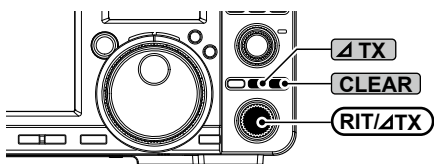

- You can change the **CLEAR** operation.

MENU » **SET > Function > Quick RIT/ΔTX Clear**

◇ ΔTX monitor function

When the ΔTX function is ON, you can directly monitor the operating frequency by holding down **XFC**.

- While monitoring, the Noise Reduction, Notch filter, and Twin PBT are temporarily turned OFF.

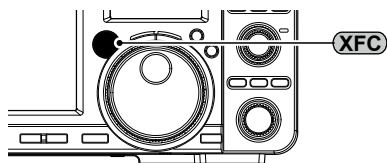

Operating CW (ADVANCED)

◇ About the CW Reverse mode

The CW-R (CW Reverse) mode reverses the receive Beat Frequency Oscillator (BFO) to receive CW signals.

Use this when interfering signals are near the desired signal, and you want to use the CW-R to reduce interference.

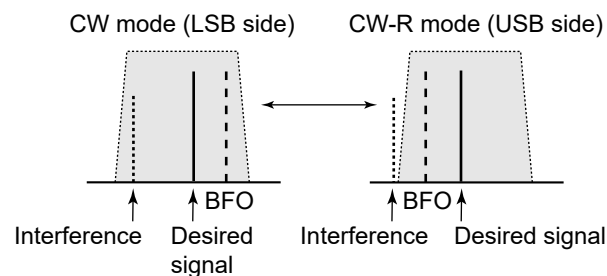

TIP: Reversing the carrier point

The carrier point of the CW mode is LSB by default. You can change it to USB in the following menu.

MENU » **SET > Function > CW Normal Side**

- When this setting is set to "USB," the CW and CW-R modes are reversed.

2 ADVANCED OPERATIONS

Operating CW (ADVANCED)

◇ Using the Memory Keyer function (KEYER)

You can send preset characters using the Memory Keyer function.

Sending

1. Display the KEYER SEND screen.
MENU » **KEYER**
 - ① The [KEYER] key is displayed only in the CW mode.
2. Push **TRANSMIT**.
 - The TX/RX indicator lights red.
 - ① If you want to automatically switch between transmit and receive, turn ON the Break-in function. (See the Basic manual.)
3. Touch a Memory Keyer key between [M1] and [M8]. (Example: [M1])

Sending memory contents

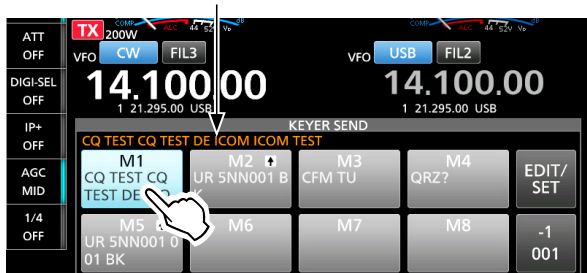

- The touched memory contents are sent.
4. To repeatedly send the memory contents, touch the Memory Keyer key for 1 second.

Repeat icon

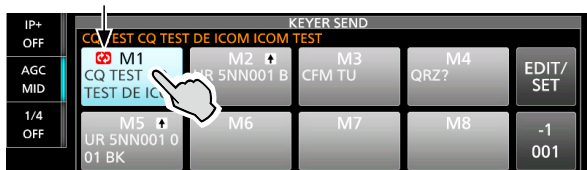

- ① The memory contents will be repeatedly sent, according to the setting in "Keyer Repeat Time."
- ① To stop sending, touch the Memory Keyer key again.

| Key | Action | |
|-----------|--|--|
| M1 ~ M8 | Touch | Sends the memory contents. |
| | Touch for 1 second |  is displayed and repeatedly sends the memory contents. You can change the repeat interval setting in "Keyer Repeat Time" in the CW-KEY SET menu. (See the Basic manual.) |
| -1 001 | Reduces the contest number counter by 1 (001). <ul style="list-style-type: none"> • You can change or reset the number in "Present Number" in the KEYER 001 menu. (p. 2-11) | |
| EDIT/SET | Displays the EDIT/SET screen. | |

Count-up trigger

The Count-up trigger enables the serial number to be automatically increased after each complete serial number exchange is sent. (Default: M2, M5)

Count-up trigger icon

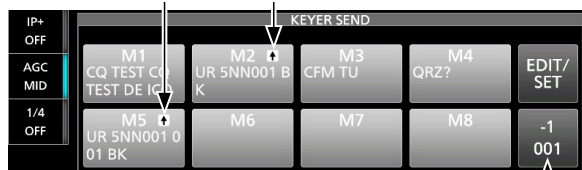

Present number counter

- ①  is displayed on the Memory Keyer set to the Count-up trigger.
- ① You can change the Count-up trigger setting in the KEYER 001 menu. (p. 2-11)

Preset Keyer memory contents

| Keyer memory | Contents |
|--------------|-----------------------------------|
| M1 | CQ TEST CQ TEST DE ICOM ICOM TEST |
| M2 | UR 5NN 001 BK |
| M3 | CFM TU |
| M4 | QRZ? |
| M5 | UR 5NN 001 001 BK |

- ① "001" is the CW contest number. You can insert or remove the CW contest number on the KEYER MEMORY screen. The "*" (asterisk) is the CW contest number. (p. 2-10)

When a USB keyboard is connected:

You can transmit the preset contents in the Keyer memory (M1 ~ M8) from a keyboard by setting "Keyboard [F1]-[F8] (KEYER)."

- ① To repeatedly send the memory contents, push [F1] ~ [F8] while holding down [Shift].

MENU » **SET > Connectors > Keyboard/Mouse**

When an external keypad is connected:

You can transmit the preset contents in the Keyer memory (M1 ~ M8) from an external device by setting "External Keypad," and then connecting an external keypad to [EXT-KEYPAD] or [MIC] on the controller.

MENU » **SET > Connectors > External Keypad**

2 ADVANCED OPERATIONS

Operating CW (ADVANCED)

◇ Keyer memory edit menu (EDIT)

You can edit the Keyer memory contents.

① You can use up to a total of 8 Memory Keyers (M1 to M8), and you can enter up to 70 characters in each memory.

Example: Entering “QSL TU DE JA3YUA TEST” into M3

1. Display the KEYSER MEMORY screen in the CW mode.

MENU » **KEYER > EDIT/SET > EDIT**

2. Touch “CFM TU” for 1 second.

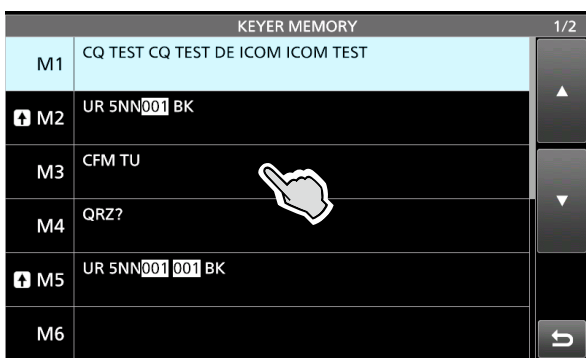

3. Touch “Edit.”

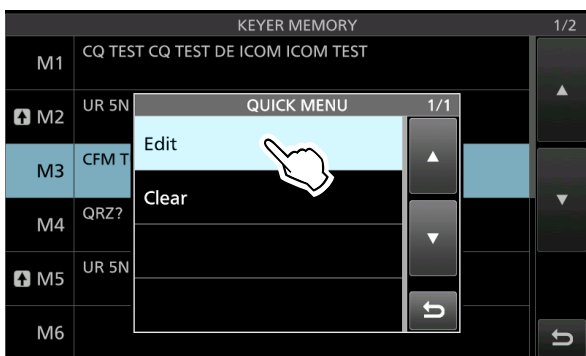

- Opens the Keyer Memory editing screen.

① When a USB keyboard is connected, you can edit directly using the keyboard without opening the Keyer Memory editing screen.

① To clear the Keyer memory contents, touch “Clear.”

4. Touch [CLR] on the Keyer Memory keyboard until the preset contents are cleared.



5. Enter “QSL TU DE JA3YUA TEST,” and then touch [ENT] to save.

① See page iii on how to enter characters.

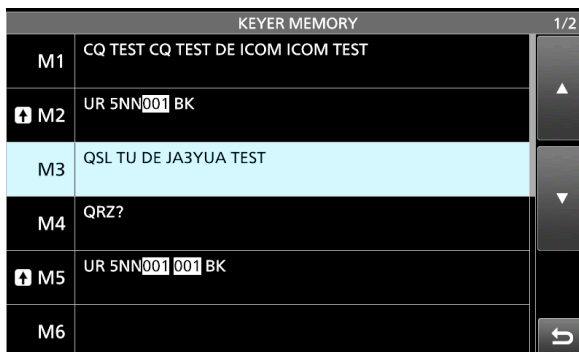

6. To close the KEYSER MEMORY screen, push **EXIT**.

About the symbols

- Enter the “^” to send a string of characters with no intercharacter space. Put “^” before a text string such as ^AR, and the string “ar” is sent with no space.
- Enter the “*” (asterisk) to insert the CW contest number. The number automatically advances by 1. You can use this for multiple Memory keyers at a time. The “*” is used in Memory Keyer M2 and M5 by default.

2 ADVANCED OPERATIONS

Operating CW (ADVANCED)

◇ Contest number menu (001 SET)

You can set the number style, Count-up trigger, and preset number.

1. Display the KEYER 001 screen in the CW mode.

MENU » **KEYER > EDIT/SET > 001 SET**

2. Touch the item to set. (Example: Number Style)

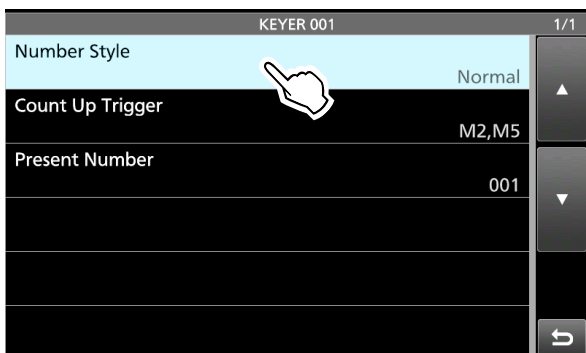

3. Touch the option to set. (Example: 190→ANO)

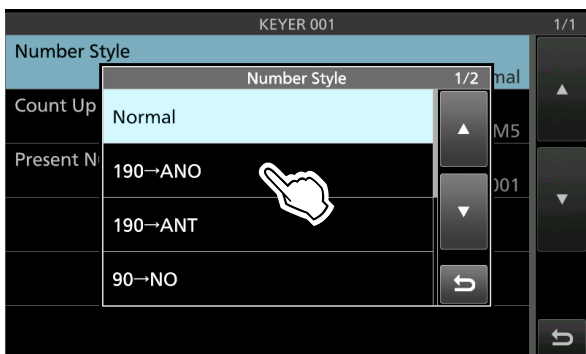

- Returns to the KEYER 001 screen.

4. To close the KEYER 001 screen, push **EXIT**.

TIP: You can set each item to its default by touching the item for 1 second, and then touching "Default" on the QUICK MENU screen.

Number Style (Default: Normal)

Sets the numbering system used for contest (serial) numbers— normal or short morse numbers.

- Select Normal, 190→ANO, 190→ANT, 90→NO, or 90→NT.

Count Up Trigger (Default: M2, M5)

Selects the memories that set the Count-up trigger. The Count-up trigger enables the serial number to be automatically increased after each complete serial number exchange is sent.

Touch the check box to turn the Count-up trigger ON or OFF.

Present Number (Default: 001)

Sets the current number for the Count-up trigger.

- Set to between 001 ~ 9999.

2 ADVANCED OPERATIONS

Operating CW (ADVANCED)

◇ Keyer Set menu (CW-KEY SET)

In this screen, you can set the memory keyer repeat time, dash weight, paddle specifications, key type, and so on.

① You can also set the same items in the Set mode.

MENU » **SET > CW-KEY Set**

See the Basic manual for details about each item.

1. Display the CW-KEY SET screen in the CW mode.

MENU » **KEYER > EDIT/SET > CW-KEY SET**

2. Touch the item to set. (Example: Side Tone Level)



3. Touch the option to set. (Example: 80%)

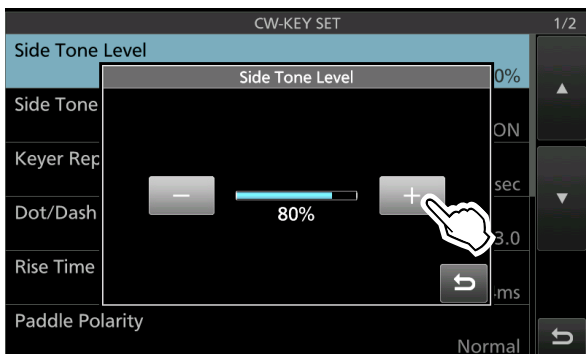

4. To close the CW-KEY SET screen, push **EXIT**.

TIP: You can set each item to its default by touching the item for 1 second, and then touching "Default" on the QUICK MENU screen.

Operating RTTY (FSK)

The IC-7760 has a built-in RTTY decoder and encoder. Using a USB keyboard and contents set in the RTTY TX memory, you can do basic RTTY operations without using an external device or software.

① If you are using RTTY software, refer to the software manual.

◇ Displaying the RTTY DECODE screen

With the built-in demodulator and decoder, received RTTY characters are displayed on the RTTY DECODE screen.

① The decode screen for the PSK mode differs slightly from that of the RTTY mode.

MENU » **DECODE**

RTTY DECODE screen

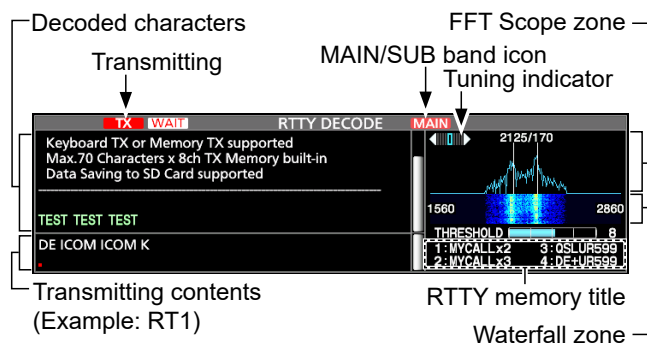

NOTE: "WAIT" is displayed next to the transmitting status indicator on the RTTY DECODE screen while buffering. If this appears, stop typing for a while and try transmitting again.

◇ Using the RTTY DECODE screen



RTTY DECODE screen <MENU1>



RTTY DECODE screen <MENU2>

| Key | Action | |
|------------------------|--|--|
| < MENU1 > < MENU2 > | Selects the Function menus. | |
| HOLD/CLR | Touch | Turns the Hold function ON or OFF. • [HOLD] is displayed, and the RTTY DECODE screen stops. |
| | Touch for 1 second | Clears the displayed characters. • While the Hold function is ON, this clears the characters and cancels the Hold function. |
| TX MEM | Opens the RTTY MEMORY screen. • Sending the RTTY MEMORY RT1 ~ RT8. | |
| ADJ | Enters the threshold level adjustment mode. • Checking the RTTY DECODE, rotate [MAIN DIAL] to adjust the threshold level to where the characters are not displayed by noise. | |
| DEF | Touch for 1 second | Resets the Threshold level to the default. ① The [DEF] key is displayed after touching [ADJ]. |
| MAIN/SUB | Selects the Main or Sub band. | |
| EXPAND | Selects the Expanded or Normal screen. | |
| LOG | Displays the RTTY DECODE LOG screen. • You can start or stop logging, and select the file type. | |
| LOG VIEW | Displays the RTTY DECODE LOG VIEW screen. • You can check the saved RTTY log files. | |
| SET | Displays the RTTY DECODE SET screen. | |

2 ADVANCED OPERATIONS

Operating RTTY (FSK)

◇ RTTY decoding

Rotate **MAIN DIAL** to tune a signal.



① Information

- Aim for a symmetrical wave form, and be sure the peak points align with the mark (2125 Hz) and shift (170 Hz) frequency lines in the FFT scope.
- Tune to where both “◀” and “▶” are displayed in the tuning indicator.
- The S-meter displays the signal strength, when a signal is received.
- If you are receiving an RTTY signal but cannot decode correctly, try the RTTY-R (reverse) mode.

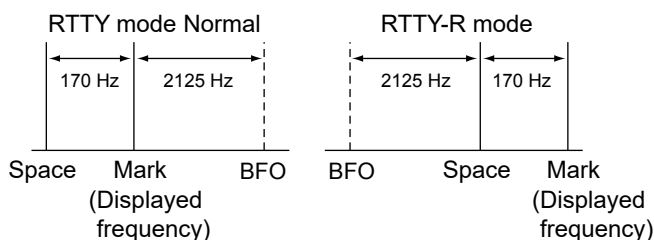

TIP: If you cannot receive, change the following settings.

MENU » **SET > Function > RTTY Mark Frequency**

MENU » **SET > Function > RTTY Shift Width**

◇ Twin Peak Filter (TPF)

The Twin Peak Filter (TPF) changes the audio frequency response by boosting the mark and space frequencies for better reception of RTTY signals, or for decoding the AF output signal on a PC.

- Push **APF/TPF** to turn ON the Twin Peak Filter.

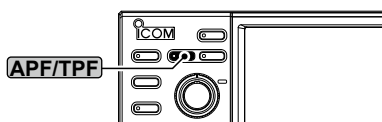

- The TPF icon is displayed, and the TPF indicator on **APF/TPF** lights.

- Pushing **APF/TPF** turns the function ON or OFF.
- You can also turn the function ON or OFF on the **FUNCTION** screen.

NOTE: When using the Twin Peak Filter, the received audio output may increase. This is not a malfunction.

◇ Using the RTTY Memory function

You can transmit the preset characters on the RTTY MEMORY screen.

Transmitting

1. Display the RTTY DECODE screen in the RTTY mode.

MENU » **DECODE**

2. Touch [TX MEM].



3. Touch an RTTY memory between [RT1] and [RT8] to transmit. (Example: RT1)

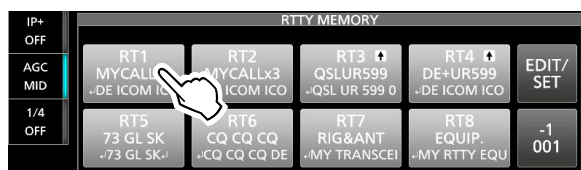

Transmitting



Transmitting contents are displayed.

- The TX status indicator lights red and the Po meter swings.
- ① To cancel the transmission and to return to the RTTY DECODE screen, push **EXIT**.
 - ① After transmitting, automatically returns to receive.

| Key | Action | |
|-----------|--------|--|
| RT1 ~ RT8 | Touch | Sends the memory contents. |
| -1 001 | | Reduces the contest number counter by 1 (001). • You can change or reset the number in “Present Number” in the RTTY 001 menu. (p. 2-18) |
| EDIT/SET | | Displays the EDIT/SET screen. |

2 ADVANCED OPERATIONS

Operating RTTY (FSK)

◇ Using the RTTY Memory function

Count-up trigger

The Count-up trigger enables the serial number to be automatically increased after each complete serial number exchange is sent. (Default: RT3, RT4)

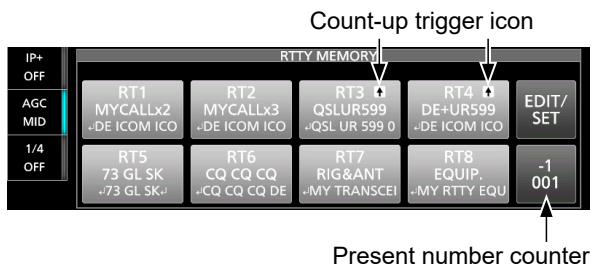

- ① is displayed on the RTTY memory set to the Count-up trigger.
- ② You can change the Count-up trigger setting in the RTTY 001 menu. (p. 2-18)

Preset memory contents

| Memory | Title | Preset characters by default |
|--------|----------|--|
| RT1 | MYCALLx2 | ↓ DE ICOM ICOM K ↓ |
| RT2 | MYCALLx3 | ↓ DE ICOM ICOM ICOM K ↓ |
| RT3 | QSLUR599 | ↓ QSL UR 599 001 001 BK ↓ |
| RT4 | DE+UR599 | ↓ QSL DE ICOM ICOM UR 599 001 001 BK ↓ |
| RT5 | 73 GL SK | ↓ 73 GL SK ↓ |
| RT6 | CQ CQ CQ | ↓ CQ CQ CQ DE ICOM ICOM ICOM K ↓ |
| RT7 | RIG&ANT | ↓ MY TRANSCEIVER IS IC-7760 & ANTENNA IS A 3-ELEMENT TRIBAND YAGI. ↓ |
| RT8 | EQUIP. | ↓ MY RTTY EQUIPMENT IS INTERNAL FSK UNIT & DEMODULATOR OF THE IC-7760. ↓ |

- ① "001" is the contest number. You can insert or remove the contest number on the RTTY MEMORY screen. The "*" (asterisk) is the contest number. (p. 2-17)

When a USB keyboard is connected:

- You can transmit the preset contents in the RTTY memory (RT1 ~ RT8) from a keyboard by pushing [F1] ~ [F8] on the USB keyboard. After transmitting the contents, you can directly enter an RTTY message on the keyboard, and then push [F12] to transmit. To return to receive, push [F12] again.
- If the Auto TX/RX function is set to "OFF" or "AUTO RX" (p. 2-16), you can display the preset contents on the RTTY DECODE screen, and then transmit it by pushing [F12] on the keyboard.
- To scroll the decoded or transmitting contents, push [Page Up] or [Page Down].

When an external keypad is connected:

You can transmit the preset contents in the RTTY memory (RT1 ~ RT8) from an external device by setting "External Keypad," and then connecting an external keypad to [EXT-KEYPAD] or [MIC] on the controller.

MENU » **SET > Connectors > External Keypad**

2 ADVANCED OPERATIONS

Operating RTTY (FSK)

◇ Setting the RTTY Automatic TX/RX

You can set to automatically transmit the RTTY memory contents, or to automatically return to receive after transmitting each memory (RT1 ~ RT8).

| Selection | Action |
|------------|--|
| OFF | The selected memory contents are displayed on the RTTY DECODE screen. Push [F12] on the keyboard to transmit the selected memory, and push [F12] again to return to receive. |
| AUTO TX/RX | Automatically transmits the selected memory and returns to receive. |
| AUTO TX | Automatically transmits the selected memory, and then returns to receive by pushing [F12] on the keyboard. |
| AUTO RX | The selected memory contents are displayed on the RTTY DECODE screen. Push [F12] on the keyboard to transmit the selected memory, and then it automatically returns to receive after transmission. |

1. Display the RTTY MEMORY screen in the RTTY mode.

MENU » **DECODE > TX MEM > EDIT/SET > EDIT**

2. Touch the setting memory's option.
(Example: RT1's AUTO TX/RX)

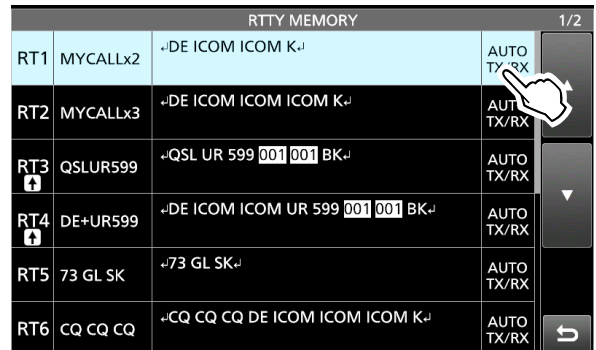

3. Touch to select an option.
(Example: AUTO TX)

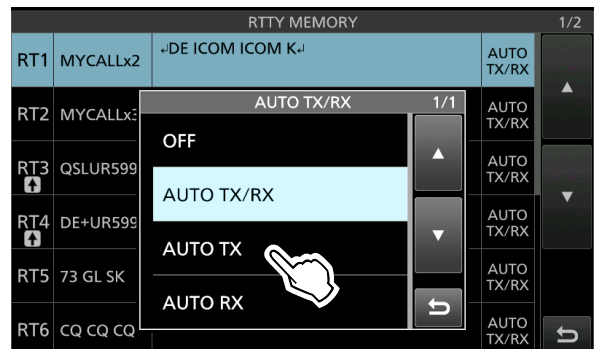

4. To close the RTTY MEMORY screen, push **EXIT**.

Operating RTTY (FSK)

◇ Editing an RTTY memory

You can edit the characters in the RTTY memories. You can save and transmit 8 RTTY memories (RT1 ~ RT8) for often-used RTTY messages. Each RTTY memory can contain up to 70 characters.

Example: Editing the content in RT2

1. Display the RTTY MEMORY screen in the RTTY mode.

MENU » **DECODE > TX MEM > EDIT/SET > EDIT**

2. Touch the memory for 1 second.

| RTTY MEMORY | | | | 1/2 |
|-------------|----------|-------------------------|------------|-----|
| RT1 | MYCALLx2 | ←DE ICOM ICOM K↓ | AUTO TX/RX | ▲ |
| RT2 | MYCALLx3 | ←DE ICOM ICOM ICOM K↓ | AUTO TX/RX | ▲ |
| RT3 | QSLUR599 | ←QSL UR 599 001 001 BK↓ | AUTO TX/RX | ▲ |

3. Touch “Edit Memory Content.”

| RTTY MEMORY | | | | 1/2 |
|-------------|----------|----------------------------------|------------|-----|
| RT1 | MYCALLx2 | ←DE ICOM ICOM K↓ | AUTO TX/RX | ▲ |
| RT2 | MYCALLx3 | ←DE ICOM ICOM ICOM K↓ | AUTO TX/RX | ▲ |
| RT3 | QSLUR599 | ←QSL UR 599 001 001 BK↓ | AUTO TX/RX | ▲ |
| RT4 | DE+UR599 | ←DE ICOM ICOM UR 599 001 001 BK↓ | AUTO TX/RX | ▲ |
| RT5 | 73 GL SK | ←73 GL SK↓ | AUTO TX/RX | ▲ |
| RT6 | CQ CQ CQ | ←CQ CQ CQ DE ICOM ICOM ICOM K↓ | AUTO TX/RX | ▲ |

| QUICK MENU | | 1/1 |
|---------------------|---|-----|
| Edit Memory Content | ▲ | ▲ |
| Edit Name | ▼ | ▼ |
| AUTO TX/RX | ▼ | ▼ |
| Clear | ↶ | ↶ |

- Opens the RTTY Memory editing screen.
 - ① When a USB keyboard is connected, you can edit directly using the keyboard without opening the RTTY Memory editing screen.
 - ① To edit the memory name, touch “Edit Name.”
To change the RTTY Automatic TX/RX setting, touch “AUTO TX/RX.”
To clear the RTTY memory contents, touch “Clear.”
4. To clear a character, touch [←] or [→] to move the cursor, then touch [CLR].

| RTTY MEMORY (RT2) | | | | | | | | | | |
|-------------------|-----------------------|-------|---|---|---|---|---|---|---|------|
| ← | ↓DE ICOM ICOM ICOM K↓ | → | | | | | | | | |
| Q | W | E | R | T | Y | U | I | O | P | CLR |
| A | S | D | F | G | H | J | K | L | | SYMB |
| Z | X | C | V | B | N | M | | | | ENT |
| AB⇄12 | / | SPACE | , | . | | | | | | ↶ |

5. Enter new characters, and then touch [ENT] to save.
① See page iii on how to enter characters.

| RTTY MEMORY (RT2) | | | | | | | | | | |
|-------------------|-------------|-------|---|---|---|---|---|---|---|------|
| ← | ↓DE JA3YUA↓ | → | | | | | | | | |
| Q | W | E | R | T | Y | U | I | O | P | CLR |
| A | S | D | F | G | H | J | K | L | | SYMB |
| Z | X | C | V | B | N | M | | | | ENT |
| AB⇄12 | / | SPACE | , | . | | | | | | ↶ |

| RTTY MEMORY | | | | 1/2 |
|-------------|----------|----------------------------------|------------|-----|
| RT1 | MYCALLx2 | ←DE ICOM ICOM K↓ | AUTO TX/RX | ▲ |
| RT2 | MYCALLx3 | ←DE JA3YUA↓ | AUTO TX/RX | ▲ |
| RT3 | QSLUR599 | ←QSL UR 599 001 001 BK↓ | AUTO TX/RX | ▲ |
| RT4 | DE+UR599 | ←DE ICOM ICOM UR 599 001 001 BK↓ | AUTO TX/RX | ▲ |
| RT5 | 73 GL SK | ←73 GL SK↓ | AUTO TX/RX | ▲ |
| RT6 | CQ CQ CQ | ←CQ CQ CQ DE ICOM ICOM ICOM K↓ | AUTO TX/RX | ▲ |

6. To close the RTTY MEMORY screen, push **EXIT**.

About the symbols

Enter the “*” (asterisk) to insert the contest number. The number automatically advances by 1. You can use this for multiple memories at a time. The “*” is used in RTTY Memory RT3 and RT4 by default.

2 ADVANCED OPERATIONS

Operating RTTY (FSK)

◇ Contest number menu (001 SET)

You can set the Count-up trigger and preset number.

1. Display the RTTY 001 screen in the RTTY mode.

MENU » **DECODE > TX MEM > EDIT/SET > 001 SET**

2. Touch the item to set.
(Example: Count Up Trigger)

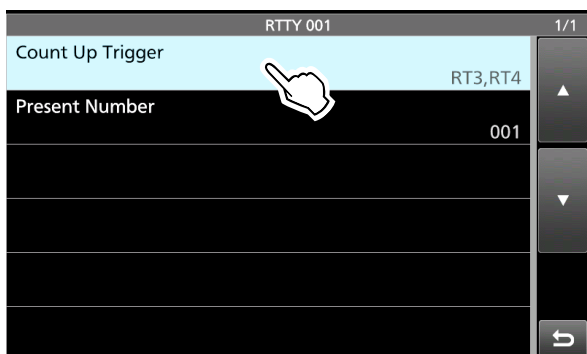

3. Touch the option to set. (Example: RT1)

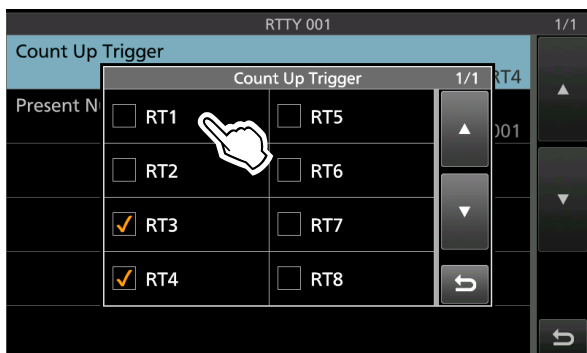

- Returns to the RTTY 001 screen.

4. To close the RTTY 001 screen, push **EXIT**.

TIP: You can set each item to its default by touching the item for 1 second, and then touching "Default" on the QUICK MENU screen.

Count Up Trigger (Default: RT3, RT4)

Selects the memories that set the Count-up trigger. The Count-up trigger enables the serial number to be automatically increased after each complete serial number exchange is sent. Touch the check box to turn the Count-up trigger ON or OFF.

Present Number (Default: 001)

Sets the current number for the Count-up trigger.

- Set to between 001 ~ 9999.

Operating RTTY (FSK)

◇ Turning ON the RTTY log

Turn ON the RTTY log to save your TX and RX RTTY operating record onto an SD card.

- ① You can select the data format type in “Log Set” on the RTTY DECODE LOG screen.
- ② The log is saved even while “HOLD” is ON.

1. Display the RTTY DECODE LOG screen.

MENU » **DECODE > <MENU1> > LOG**

2. Touch “Decode Log.”

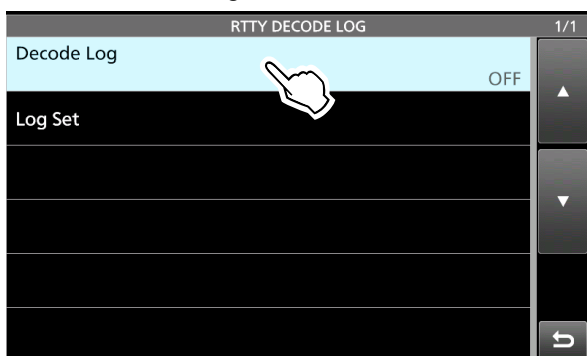

3. Touch “ON.”

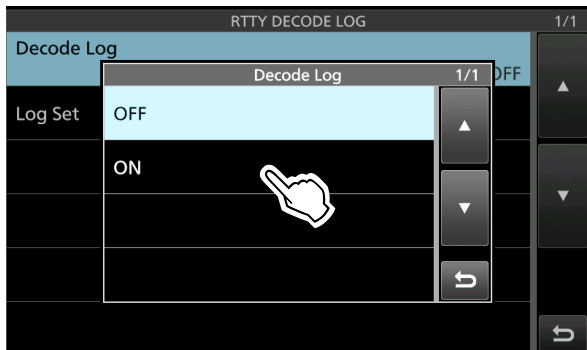

4. To close the RTTY DECODE LOG screen, push **EXIT**.
 - “●” is displayed on the RTTY DECODE screen while the RTTY log is ON.
5. To turn OFF the RTTY log, touch “OFF” in step 3.

TIP: You can set each item to its default by touching the item for 1 second, and then touching “Default” on the QUICK MENU screen.

◇ RTTY DECODE LOG SET screen

In this screen, you can set the log file type.

1. Display the RTTY DECODE LOG screen.

MENU » **DECODE > <MENU1> > LOG**

2. Touch “Log Set.”

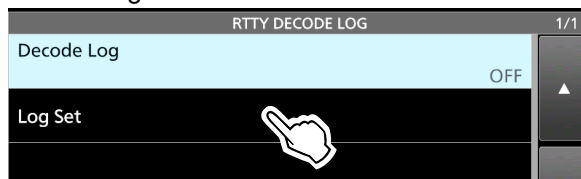

3. Touch the item to set. (Example: File Type)

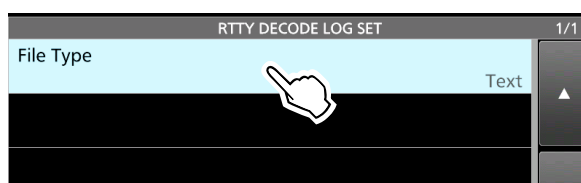

4. Touch the option to set. (Example: HTML)

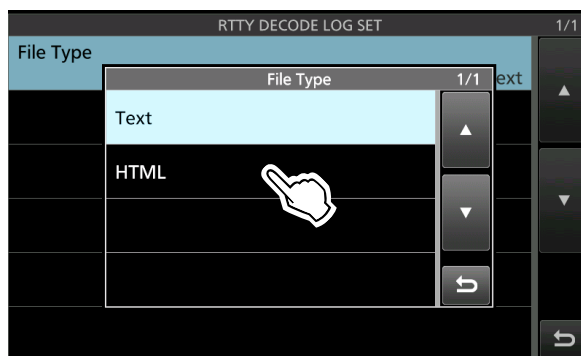

5. To close the RTTY DECODE LOG SET screen, push **EXIT** several times.

TIP: You can set each item to its default by touching the item for 1 second, and then touching “Default” on the QUICK MENU screen.

File Type (Default: Text)

Selects the file type to save a log onto an SD card from Text and HTML.

- ① You cannot change the file type while logging.

2 ADVANCED OPERATIONS

Operating RTTY (FSK)

◇ Viewing the RTTY log contents

You can view the saved RTTY log contents.

1. Insert the SD card that the RTTY log is saved.
2. Display the RTTY DECODE LOG VIEW screen in the RTTY mode.

MENU » **DECODE > <MENU1> > LOG VIEW**

3. Touch the log file to view.

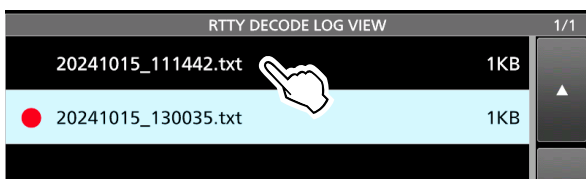

- The file with “●” in front of it is logging. You cannot view this log's contents.

4. To close the RTTY DECODE LOG VIEW screen, push **EXIT** several times.

Checking the file information and deleting a file

1. Touch the log file that you want to view or delete for 1 second.
2. Touch an item from “File Information,” “Delete,” and “Delete All.”

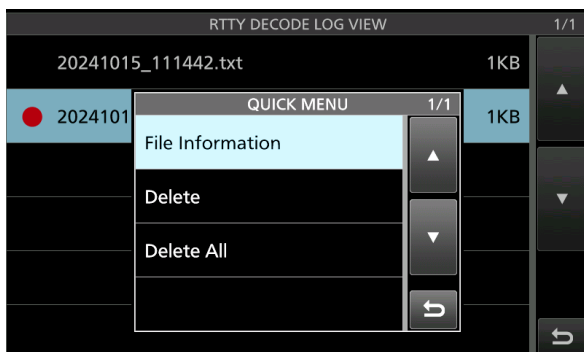

- File Information: Displays the file name, size, and logged date.
- Delete: Deletes the selected log file.
- Delete All: Deletes all log files.

◇ RTTY DECODE SET screen

In this screen, you can set the time stamp setting, and other RTTY settings.

1. Display the RTTY DECODE SET screen.

MENU » **DECODE > <MENU1> > SET**

2. Touch the item to set.
(Example: FFT Scope Averaging)

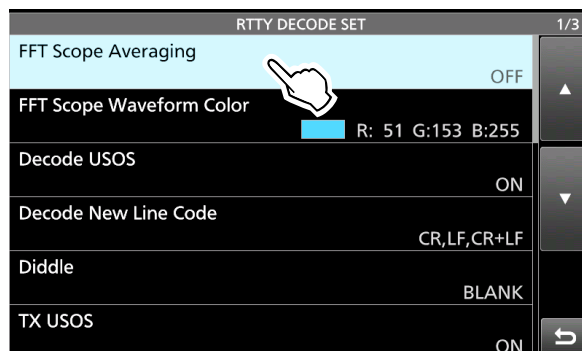

3. Touch the option to set. (Example: 2)

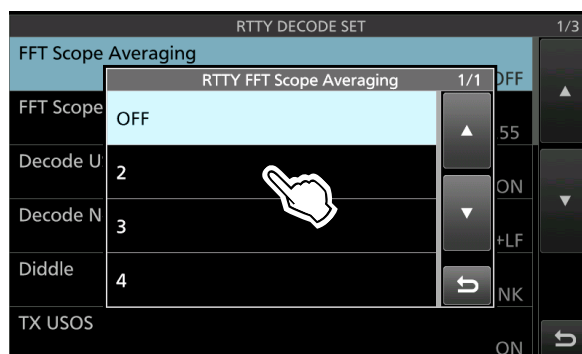

4. To close the RTTY DECODE SET screen, push **EXIT** several times.

TIP: You can set each item to its default by touching the item for 1 second, and then touching “Default” on the QUICK MENU screen.

2 ADVANCED OPERATIONS

Operating RTTY (FSK)

◇ RTTY DECODE SET screen

FFT Scope Averaging (Default: OFF)

Sets the FFT scope waveform averaging function to between 2 and 4, or OFF.

- ① Use the default or smaller FFT scope waveform number for tuning.

FFT Scope Waveform Color (Default: R: 51, G: 153, B: 255)

Sets the waveform color for the FFT scope.

- ① Touch and select the R (Red), G (Green), or B (Blue) scale, and then rotate **ⓂMULTI** to adjust the level from 0 to 255.
- ② The color is displayed in the box above the RGB scale.

Decode USOS (Default: ON)

Turns the letter code decoding capability ON or OFF after receiving a "space."

- ① USOS stands for UnShift On Space function.
- OFF: Decodes as a character code.
- ON: Decodes as a letter code.

Decode New Line Code (Default: CR, LF, CR+LF)

Selects the internal RTTY decoder new line code.

- ① CR stands for Carriage Return, and LF stands for Line Feed.
- CR,LF,CR+LF: Makes a new line with any code.
- CR+LF: Makes a new line with only a CR+LF code.

Diddle (Default: BLANK)

Selects the diddle status code.

While transmitting in the RTTY mode, the selected code is transmitted when there is no code to transmit.

- OFF: Turns OFF the Diddle function.
- BLANK: Transmits blank codes.
- LTRS: Transmits letter codes.

TX USOS (Default: ON)

Explicitly inserts the FIGS character, even though it is not required by the receiving station.

- OFF: Does not insert FIGS.
- ON: Inserts FIGS.

Auto CR+LF by TX (Default: ON)

Selects whether or not to automatically send a new line code (CR+LF) when transmitting.

- OFF: Does not transmit the CR+LF code.
- ON: Transmits a CR+LF code.

Time Stamp (Default: ON)

Selects whether or not to display the time stamp (date, transmission time, and reception time) on the RTTY DECODE screen and to add it in the log.

- OFF: Does not display and add the time stamp.
- ON: Displays and adds the time stamp in the log.

Time Stamp (Time) (Default: Local)

Selects whether to display the log on the RTTY DECODE screen and to save it with the local time or with the CLOCK2's time.

Time Stamp (Frequency) (Default: ON)

Selects whether or not to display the frequency on the RTTY DECODE screen and to save it in the log.

- OFF: Does not display and add the frequency.
- ON: Displays and adds the frequency in the log.

Font Color (Receive) (Default: R: 128, G: 255, B: 128)

Font Color (Transmit) (Default: R: 255, G: 106, B: 106)

Font Color (Time Stamp) (Default: R: 0, G: 155, B: 189)

Font Color (TX Buffer) (Default: R: 255, G: 255, B: 255)

Sets the text font color for received, transmit, time stamp, and TX buffer characters.

- ① Touch and select the R (Red), G (Green), or B (Blue) scale, and then rotate **ⓂMULTI** to adjust the level from 0 to 255.

- ② The color is displayed in the box above the RGB scale.

Operating PSK

A PSK encoder/decoder is built into the IC-7760. Using a USB keyboard and contents set in the PSK TX memory, you can do basic PSK operations without using an external device or software.

① If you are using PSK software, refer to the software manual.

◇ Displaying the PSK DECODE screen

With the built-in demodulator and decoder, received PSK signals are displayed on the PSK DECODE screen.

① The decode screen for the RTTY mode differs slightly from that of the PSK mode.

MENU » **DECODE**

PSK DECODE screen

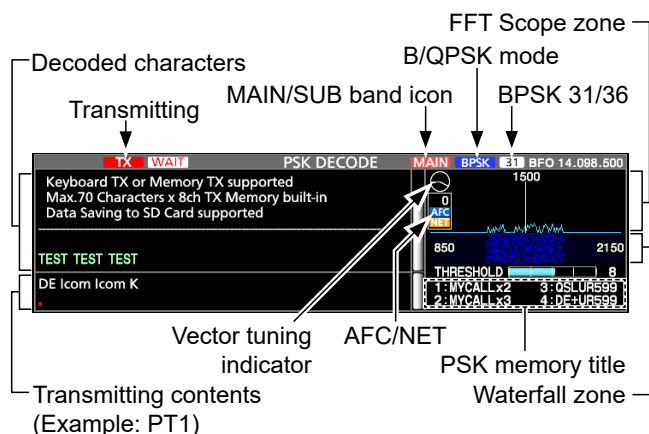

NOTE: “WAIT” is displayed next to the transmitting status indicator on the PSK DECODE screen while buffering. If this appears, stop typing for a while and try transmitting again.

Vector tuning indicator

The Vector tuning indicator is displayed when tuning PSK signals by rotating **(MAIN DIAL)**.

Indication example:

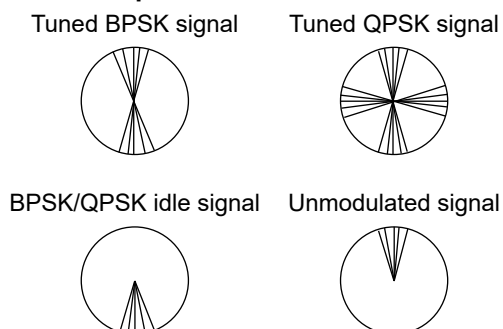

◇ Using the PSK DECODE screen



PSK DECODE screen <MENU1>



PSK DECODE screen <MENU2>

| Key | Action | |
|------------------------|---|--|
| < MENU1 > < MENU2 > | Selects the Function menus. | |
| HOLD/CLR | Touch | Turns the Hold function ON or OFF. • (HOLD) is displayed, and the PSK DECODE screen stops. |
| | Touch for 1 second | Clears the displayed characters. • While the Hold function is ON, this clears the characters and cancels the Hold function. |
| AFC/NET | Touch | Selects between AFC (AFC: ON), AFC NET (AFC/NET: ON) or OFF. |
| | Touch for 1 second | Adds the offset frequency to the operating frequency. |
| TX MEM | Opens the PSK MEMORY screen. • Sending the PSK MEMORY PT1 ~ PT8. | |
| ADJ | Enters the threshold level adjustment mode. • Checking the PSK DECODE, rotate (MAIN DIAL) to adjust the threshold level to where the characters are not displayed by noise. | |
| DEF | Touch for 1 second | Resets the Threshold level to the default. ① The [DEF] key is displayed after touching [ADJ]. |
| MAIN/SUB | Selects the Main or Sub band. | |
| EXPAND | Selects the Expanded or Normal screen. | |
| B/QPSK | Selects the BPSK or QPSK mode. | |
| 31/63 | Selects the BPSK31 or BPSK63 mode. | |
| LOG | Displays the PSK DECODE LOG screen. • You can start or stop logging, and select the file type. | |
| LOG VIEW | Displays the PSK DECODE LOG VIEW screen. • You can check the saved PSK log files. | |
| SET | Displays the PSK DECODE SET screen. | |

Operating PSK

◇ PSK decoding

You can fine tune the PSK signal using the Vector tuning indicator and waterfall display.

- When a PSK signal is received, the vertical line appears on the waterfall display.
- Tune the vertical line to the center of the waterfall display.
- The signal is properly tuned when the radiated lines in the Vector tuning indicator narrow, as shown on the previous page.



- ① If two or more signals are in the band, slowly rotate **MAIN DIAL** to tune the displayed signal to the 1500 Hz tone.
- ① You can change the PSK tone frequency for receiving, in the following item.

MENU » **SET > Function > PSK Tone Frequency**

About the QPSK mode operation

The QPSK (Quadrature Phase Shift Keying) mode has error correction capability to provide better decoding than the BPSK mode in marginal conditions. However, more accurate tuning is required, due to the tight phase margin of QPSK.

- ① If the received signal is not properly demodulated, try selecting the PSK-R mode.
 - In the QPSK mode, the phase shift direction must be the same on both the transmit and receive sides.
 - To receive the reverse direction signal, select the PSK-R mode to match the phase shift direction to the transmit side.

◇ AFC/NET function

The IC-7760 has an Auto Frequency Control (AFC) function which automatically tunes the PSK signal. It also has a NET function that transmits the PSK signal tuned using the AFC function.

1. Display the PSK DECODE screen in the PSK mode.

MENU » **DECODE**

2. Touch [AFC/NET].

① Touching this key toggles between **AFC** (AFC: ON), **AFC NET** (AFC/NET: ON) or OFF (no icon).

① While the offset between the operating frequency and the PSK signal is displayed, touching [AFC/NET] for 1 second adds the offset frequency to the operating frequency.

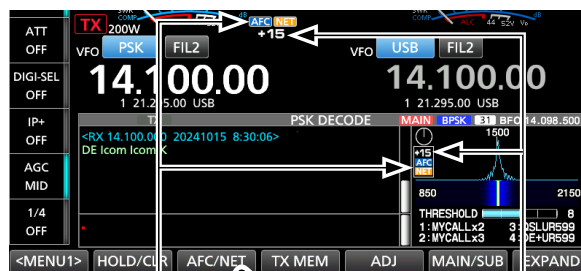

AFC, NET icons

Frequency offset
(Example: 15 Hz)

NOTE:

- The AFC function may not tune the signal properly when a weak PSK signal is received.
- The AFC tuning range is set to ± 15 Hz by default. You can select set to ± 8 Hz in the following item.

MENU » **DECODE > <MENU2> > SET > AFC Range**

Operating PSK

◇ Using the PSK Memory function

You can transmit the preset characters on the PSK MEMORY screen.

Transmitting

1. Display the PSK DECODE screen in the PSK mode.

MENU » **DECODE**

2. Touch [TX MEM].



3. Touch an PSK memory between [PT1] and [PT8] to transmit. (Example: PT1)

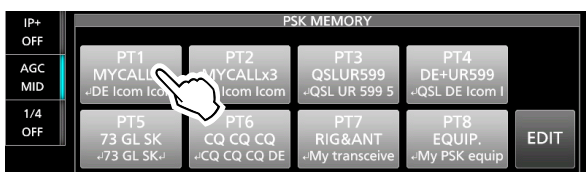

Transmitting



Transmitting contents are displayed.

- The TX status indicator lights red and the Po meter swings.
- ① To cancel the transmission and to return to the PSK DECODE screen, push **EXIT**.
- ① After transmitting, automatically returns to receive.

| Key | Action | |
|-----------|--------|---------------------------------|
| PT1 ~ PT8 | Touch | Sends the memory contents. |
| EDIT | | Displays the PSK MEMORY screen. |

Preset memory contents

| Memory | Title | Preset characters by default |
|--------|----------|--|
| PT1 | MYCALLx2 | ↓ DE Icom Icom K ↓ |
| PT2 | MYCALLx3 | ↓ DE Icom Icom Icom K ↓ |
| PT3 | QSLUR599 | ↓ QSL UR 599 599 BK ↓ |
| PT4 | DE+UR599 | ↓ QSL DE Icom Icom UR 599 599 BK ↓ |
| PT5 | 73 GL SK | ↓ 73 GL SK ↓ |
| PT6 | CQ CQ CQ | ↓ CQ CQ CQ DE Icom Icom Icom K ↓ |
| PT7 | RIG&ANT | ↓ My transceiver is IC-7760 & Antenna is a 3-element triband yagi. ↓ |
| PT8 | EQUIP. | ↓ My PSK equipment is internal modulator & demodulator of the IC-7760. ↓ |

When a USB keyboard is connected:

- You can transmit the preset contents in the PSK memory (PT1 ~ PT8) from a keyboard by pushing [F1] ~ [F8] on the USB keyboard. After transmitting the contents, you can directly enter a PSK message on the keyboard, and then push [F12] to transmit. To return to receive, push [F12] again.
- If the Auto TX/RX function is set to "OFF" or "AUTO RX" (p. 2-25), you can display the preset contents on the PSK DECODE screen, and then transmit it by pushing [F12] on the keyboard.
- To scroll the decoded or transmitting contents, push [Page Up] or [Page Down].

When an external keypad is connected:

You can transmit the preset contents in the PSK memory (PT1 ~ PT8) from an external device by setting "External Keypad," and then connecting an external keypad to [EXT-KEYPAD] or [MIC] on the controller.

MENU » **SET > Connectors > External Keypad**

2 ADVANCED OPERATIONS

Operating PSK

◇ Setting the PSK Automatic TX/RX

You can set to automatically transmit the PSK memory contents, or to automatically return to receive after transmitting each memory (PT1 ~ PT8).

| Selection | Action |
|------------|---|
| OFF | The selected memory contents are displayed on the PSK DECODE screen. Push [F12] on the keyboard to transmit the selected memory, and push [F12] again to return to receive. |
| AUTO TX/RX | Automatically transmits the selected memory and returns to receive. |
| AUTO TX | Automatically transmits the selected memory, and then returns to receive by pushing [F12] on the keyboard. |
| AUTO RX | The selected memory contents are displayed on the PSK DECODE screen. Push [F12] on the keyboard to transmit the selected memory, and then it automatically returns to receive after transmission. |

1. Display the PSK MEMORY screen in the PSK mode.

MENU » **DECODE > TX MEM > EDIT**

2. Touch the setting memory's option.
(Example: PT1's AUTO TX/RX)

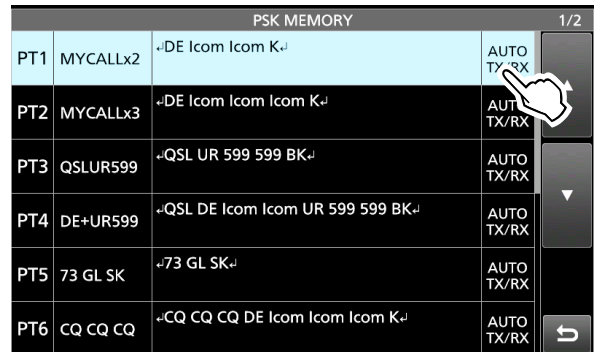

3. Touch to select an option.
(Example: AUTO TX)

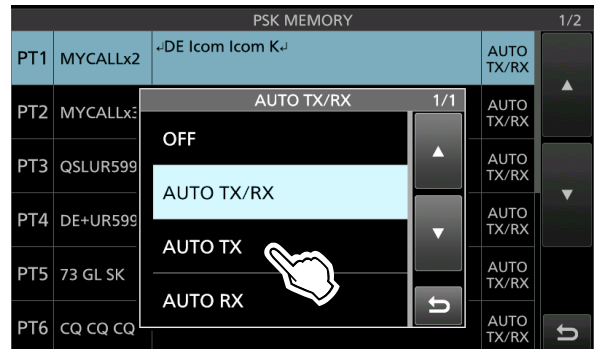

4. To close the PSK MEMORY screen, push **EXIT**.

2 ADVANCED OPERATIONS

Operating PSK

◇ Editing a PSK memory

You can edit the characters in the PSK memories. You can save and transmit 8 PSK memories (PT1 ~ PT8) for often-used PSK messages. Each PSK memory can contain up to 70 characters.

Example: Editing the content in PT2

1. Display the PSK MEMORY screen in the PSK mode.

MENU » **DECODE > TX MEM > EDIT**

2. Touch the memory for 1 second.

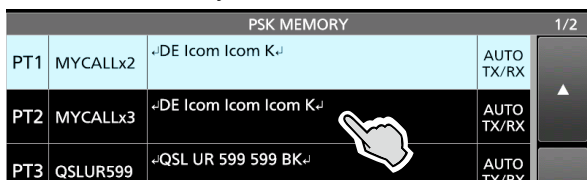

3. Touch “Edit Memory Content.”

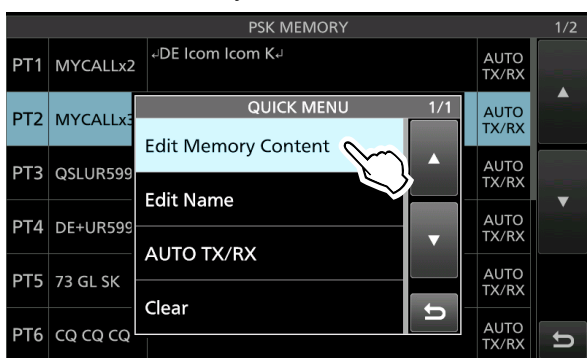

- Opens the PSK Memory editing screen.

① When a USB keyboard is connected, you can edit directly using the keyboard without opening the PSK Memory editing screen.

① To edit the memory name, touch “Edit Name.”

To change the PSK Automatic TX/RX setting, touch “AUTO TX/RX.”

To clear the PSK memory contents, touch “Clear.”

4. To clear a character, touch [←] or [→] to move the cursor, then touch [CLR].



5. Enter new characters, and then touch [ENT] to save.

① See page iii on how to enter characters.

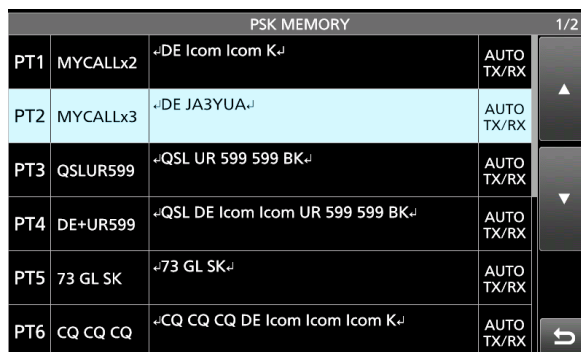

6. To close the PSK MEMORY screen, push **EXIT**.

Operating PSK

◇ Turning ON the PSK log

Turn ON the PSK log to save your TX and RX PSK operating record onto an SD card.

- ① You can select the data format type in “Log Set” on the PSK DECODE LOG screen.
- ② The log is saved even while “HOLD” is ON.

1. Display the PSK DECODE LOG screen.

MENU » **DECODE > <MENU1> > LOG**

2. Touch “Decode Log.”

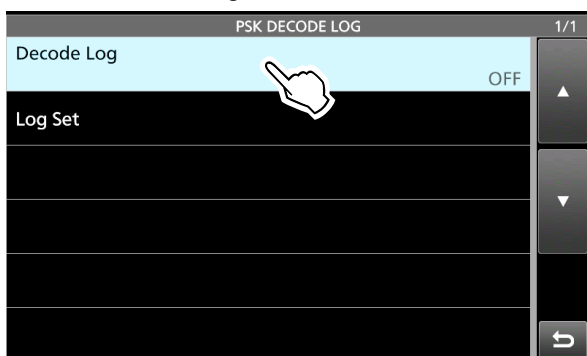

3. Touch “ON.”

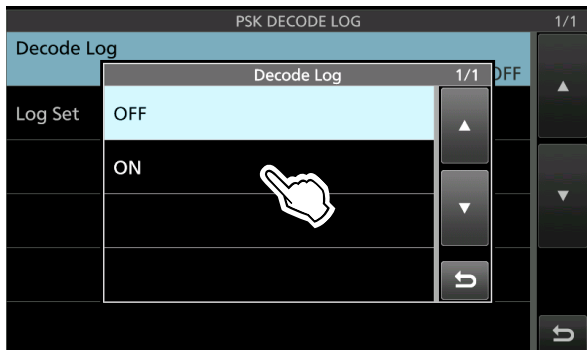

4. To close the PSK DECODE LOG screen, push **EXIT**.
 - “●” is displayed on the PSK DECODE screen while the PSK log is ON.
5. To turn OFF the PSK log, touch “OFF” in step 3.

TIP: You can set each item to its default by touching the item for 1 second, and then touching “Default” on the QUICK MENU screen.

◇ PSK DECODE LOG SET screen

In this screen, you can set the log file type.

1. Display the PSK DECODE LOG screen.

MENU » **DECODE > <MENU1> > LOG**

2. Touch “Log Set.”

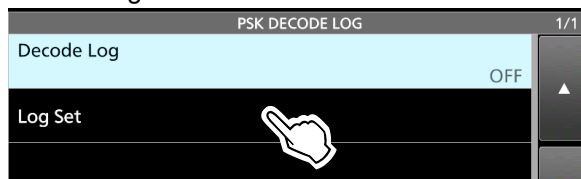

3. Touch the item to set. (Example: File Type)

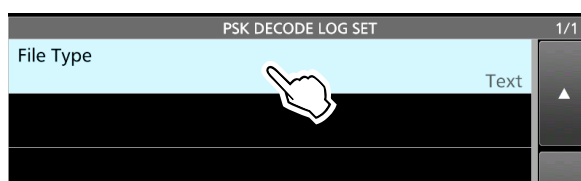

4. Touch the option to set. (Example: HTML)

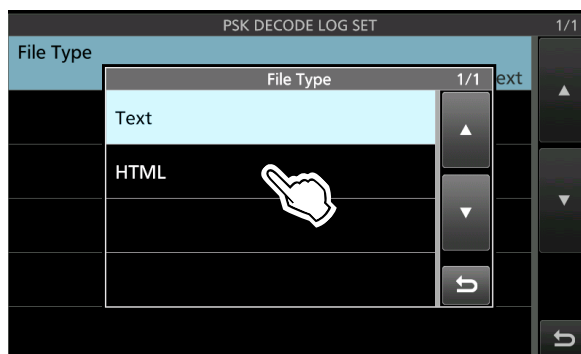

5. To close the PSK DECODE LOG SET screen, push **EXIT** several times.

TIP: You can set each item to its default by touching the item for 1 second, and then touching “Default” on the QUICK MENU screen.

File Type (Default: Text)

Selects the file type to save a log onto an SD card from Text and HTML.

- ① You cannot change the file type while logging.

Operating PSK

◇ Viewing the PSK log contents

You can view the saved PSK log contents.

1. Insert the SD card that the PSK log is saved.
2. Display the PSK DECODE LOG VIEW screen in the PSK mode.

MENU » **DECODE > <MENU1> > LOG VIEW**

3. Touch the log file to view.

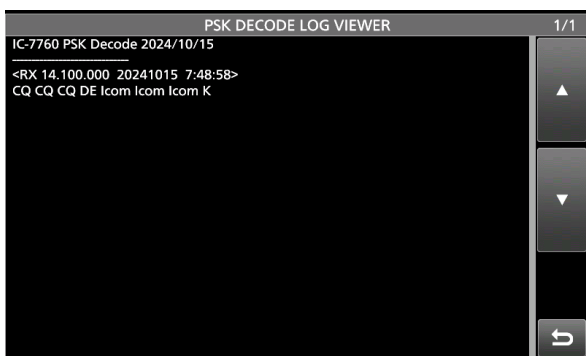
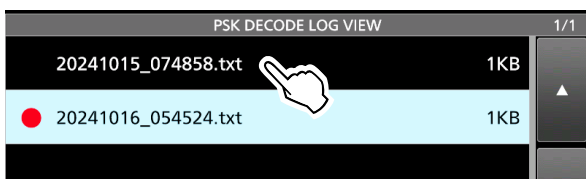

- The file with “●” in front of it is logging. You cannot view this log's contents.

4. To close the PSK DECODE LOG VIEW screen, push **EXIT** several times.

Checking the file information and deleting a file

1. Touch the log file that you want to view or delete for 1 second.
2. Touch an item from “File Information,” “Delete,” and “Delete All.”

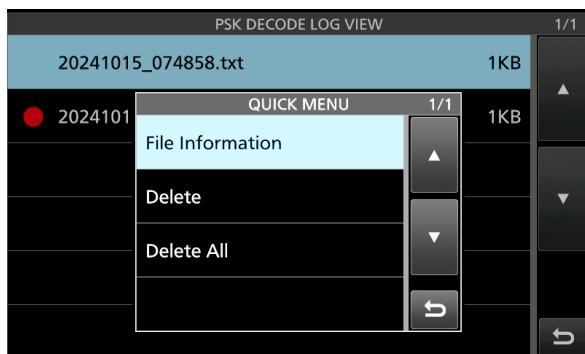

- File Information: Displays the file name, size, and logged date.
- Delete: Deletes the selected log file.
- Delete All: Deletes all log files.

◇ PSK DECODE SET screen

In this screen, you can set the time stamp setting, and other PSK settings.

1. Display the PSK DECODE SET screen.

MENU » **DECODE > <MENU1> > SET**

2. Touch the item to set.
(Example: FFT Scope Averaging)

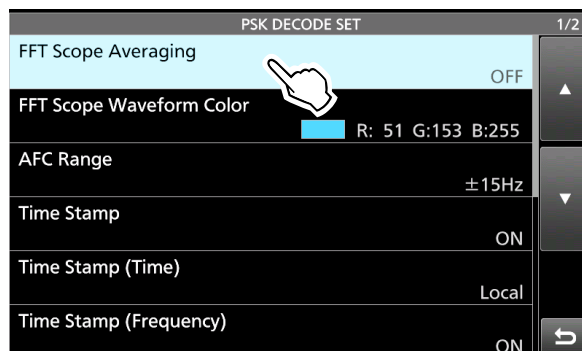

3. Touch the option to set. (Example: 2)

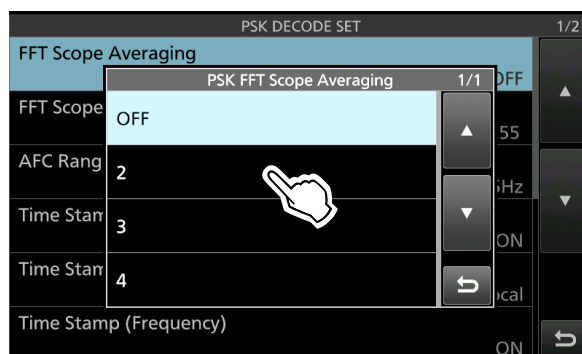

4. To close the PSK DECODE SET screen, push **EXIT** several times.

TIP: You can set each item to its default by touching the item for 1 second, and then touching “Default” on the QUICK MENU screen.

2 ADVANCED OPERATIONS

Operating PSK

◇ PSK DECODE SET screen

FFT Scope Averaging (Default: OFF)

Sets the FFT scope waveform averaging function to between 2 and 4, or OFF.

- ① Use the default or smaller FFT scope waveform number for tuning.

FFT Scope Waveform Color (Default: R: 51, G: 153, B: 255)

Sets the waveform color for the FFT scope.

- ① Touch and select the R (Red), G (Green), or B (Blue) scale, and then rotate **ⓈMULTI** to adjust the level from 0 to 255.
- ① The color is displayed in the box above the RGB scale.

AFC Range (Default: ±15 Hz)

Selects the Automatic Frequency Control (AFC) function's operating range from ±15 Hz and ±8 Hz.

- ① The AFC function may not tune the signal properly when a weak PSK signal is received.

Time Stamp (Default: ON)

Selects whether or not to display the time stamp (date, transmission time, and reception time) on the PSK DECODE screen and to add it in the log.

- OFF: Does not display and add the time stamp.
- ON: Displays and adds the time stamp in the log.

Time Stamp (Time) (Default: Local)

Selects whether to display the log on the PSK DECODE screen and to save it with the local time or with the CLOCK2's time.

Time Stamp (Frequency) (Default: ON)

Selects whether or not to display the frequency on the PSK DECODE screen and to save it in the log.

- OFF: Does not display and add the frequency.
- ON: Displays and adds the frequency in the log.

Font Color (Receive)

(Default: R: 128, G: 255, B: 128)

Font Color (Transmit)

(Default: R: 255, G: 106, B: 106)

Font Color (Time Stamp)

(Default: R: 0, G: 155, B: 189)

Font Color (TX Buffer)

(Default: R: 255, G: 255, B: 255)

Sets the text font color for received, transmit, time stamp, and TX buffer characters.

- ① Touch and select the R (Red), G (Green), or B (Blue) scale, and then rotate **ⓈMULTI** to adjust the level from 0 to 255.
- ① The color is displayed in the box above the RGB scale.

FM repeater operation

A repeater receives your transceiver's signals and simultaneously retransmits them on a different frequency to provide a greater communication range. When using a repeater, the transmit frequency shifts from the receive frequency by an offset amount. You can access a repeater using the split function.

1. Select the VFO mode.
2. Set the operating frequency in the FM mode.
(Example: 29.650.00 MHz)



3. Hold down **[SPLIT]** for 1 second.
 - Turns ON the Quick Split function.
 - Turns the Tone function ON and "TONE" is displayed.
 - The TX indicator and the repeater's receive frequency are displayed on the Sub band.

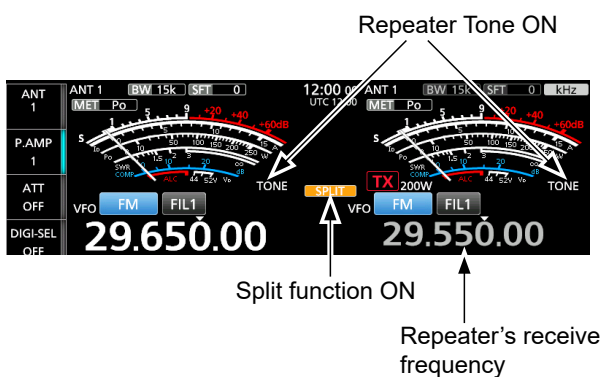

① You can set the frequency offset for the HF band.

[MENU] » SET > Function > SPLIT > **FM SPLIT Offset (HF)**

① You can set the frequency offset for the 50 MHz band.

[MENU] » SET > Function > SPLIT > **FM SPLIT Offset (50M)**

◇ Checking the repeater input signal

You can check whether or not you can directly receive another station's transmit signal, by listening to the repeater input frequency.

① While listening, the TX/RX indicator lights green, and then the Noise Reduction and Notch Filter settings are canceled.

- While receiving, hold down **[XFC]** to listen to the repeater input frequency.

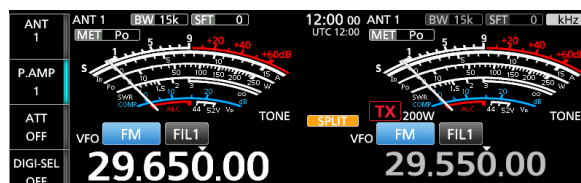
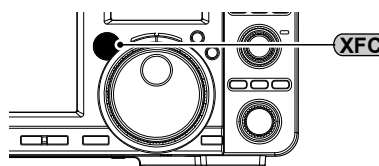

Quick Split function ON

While holding down **[XFC]**, ▼ ▲ Release **[XFC]**.

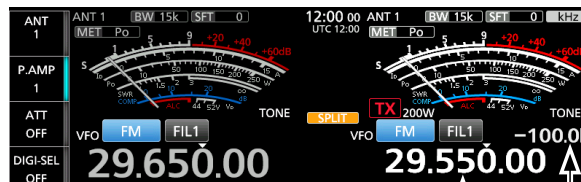

Another station's transmit frequency
The offset between transmit and receive

2 ADVANCED OPERATIONS

FM repeater operation

◇ Setting the repeater tone frequency

Most repeaters require a subaudible tone to be accessed. Subaudible tones are superimposed on your signal, and must be set in advance. Do the following steps to set the tone frequency.

1. Select the FM mode.
2. Touch [TONE] for 1 second.

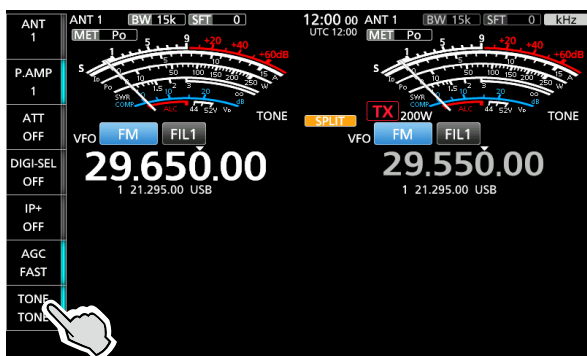

3. Rotate **(MAIN DIAL)** to set the desired subaudible tone frequency.

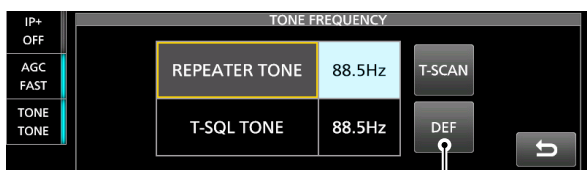

You can reset to the default setting by touching this key for 1 second.

Selectable tone frequencies

| | | | | | | |
|------|-------|-------|-------|-------|-------|-------|
| 67.0 | 88.5 | 114.8 | 151.4 | 177.3 | 203.5 | 250.3 |
| 69.3 | 91.5 | 118.8 | 156.7 | 179.9 | 206.5 | 254.1 |
| 71.9 | 94.8 | 123.0 | 159.8 | 183.5 | 210.7 | |
| 74.4 | 97.4 | 127.3 | 162.2 | 186.2 | 218.1 | |
| 77.0 | 100.0 | 131.8 | 165.5 | 189.9 | 225.7 | |
| 79.7 | 103.5 | 136.5 | 167.9 | 192.8 | 229.1 | |
| 82.5 | 107.2 | 141.3 | 171.3 | 196.6 | 233.6 | |
| 85.4 | 110.9 | 146.2 | 173.8 | 199.5 | 241.8 | |

Checking the repeater tone frequency

You can check the tone frequency by receiving the repeater's input frequency using the tone scan. To receive the input signals, the transceiver detects the subaudible tone frequency using the tone scan function.

1. Touch [T-SCAN].

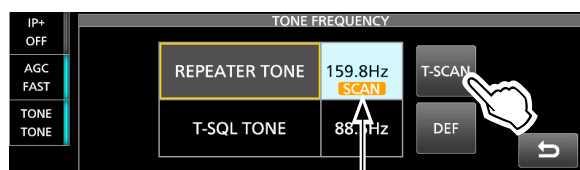

Blinks while scanning

- The scan starts, and then stops when the matching tone frequency from the repeater is received.
2. To close the TONE FREQUENCY screen, push **(EXIT)**.

Tone squelch operation

FM mode

The Tone squelch opens only when you receive a signal that includes a matching subaudible tone in the FM mode. You can silently wait for calls from other stations using the same tone.

When you transmit, the tone frequency is superimposed on your own signal.

1. Set the operating frequency in the FM mode.
2. Touch [TONE] several times to select "TSQL."

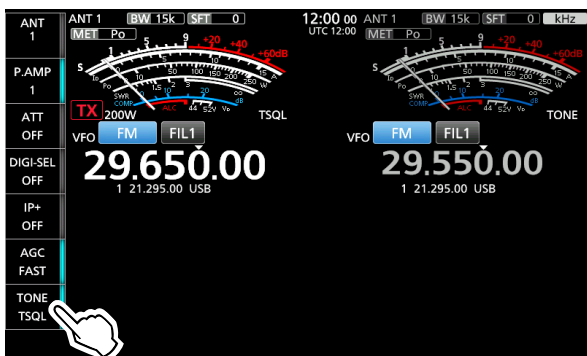

① Touching [TONE] changes between "TONE," "TSQL," and "OFF."

3. Touch [TONE] for 1 second.

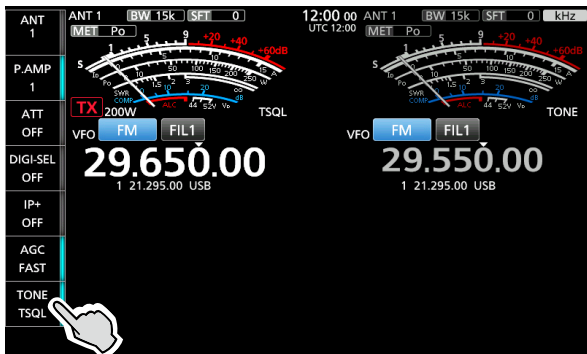

4. Rotate (MAIN DIAL) to set the tone frequency.

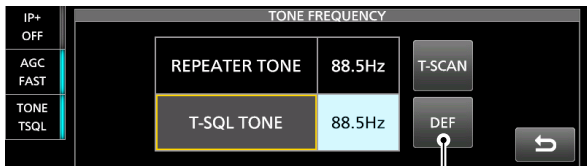

You can reset to the default setting by touching this key for 1 second.

Selectable tone frequencies

| | | | | | | |
|------|-------|-------|-------|-------|-------|-------|
| 67.0 | 88.5 | 114.8 | 151.4 | 177.3 | 203.5 | 250.3 |
| 69.3 | 91.5 | 118.8 | 156.7 | 179.9 | 206.5 | 254.1 |
| 71.9 | 94.8 | 123.0 | 159.8 | 183.5 | 210.7 | |
| 74.4 | 97.4 | 127.3 | 162.2 | 186.2 | 218.1 | |
| 77.0 | 100.0 | 131.8 | 165.5 | 189.9 | 225.7 | |
| 79.7 | 103.5 | 136.5 | 167.9 | 192.8 | 229.1 | |
| 82.5 | 107.2 | 141.3 | 171.3 | 196.6 | 233.6 | |
| 85.4 | 110.9 | 146.2 | 173.8 | 199.5 | 241.8 | |

Checking another station's tone frequency

You can check another station's tone frequency by tone scanning while the station is transmitting.

1. Touch [T-SCAN].

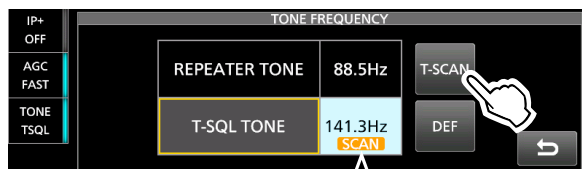

Blinks while scanning

- The scan starts, and then stops when the matching tone frequency from the other station is received.
2. To close the TONE FREQUENCY screen, push **EXIT**.

Data communication

SSB-DATA, AM-DATA, and FM-DATA modes

You can operate the data mode using AFSK (Audio Frequency Shift Keying).

① When operating PSK31, SSTV, JT65B, or FT8 with a PC application software, refer to the software's instruction manual.

1. Connect a PC or other device to the transceiver.
 - ① See page 1-4 for details.
2. Set the operating frequency and mode.



3. Refer to the application software for communication details.

- ① When operating in the SSB data mode, adjust the device's output level within the ALC zone. The following are automatically changed:
 - Changes the TBW setting from the SSB set to the SSB-D.
 - Changes the filter selection from the SSB filter set to the SSB-D. (However, you can still adjust the set receive IF filter bandwidths by touching the filter icon for 1 second.)
 - Enables the 1/4 Tuning function setting on the FUNCTION screen.
 - Disables the RX Tone Control settings, the Speech Compressor function, and the Drive Gain adjust level.

TIP: The carrier point is displayed when operating AFSK in the SSB data mode. See the illustration below for a tone-pair example in the LSB mode.

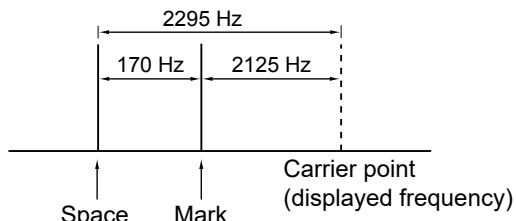

Transverter operation

You can use the Transverter function as an exciter for a transverter.

◇ Transverter setting example

This is an example of operating a 144 MHz band transverter using the IC-7760's 50 MHz band.

1. Connect the 144 MHz band transverter's RF output to [X-VERTER].
2. Set the operating band and mode. (Example: 50 MHz band (MAIN), SSB)
3. Rotate **(MAIN DIAL)** to set the frequency. (Example: 50.000.00)
4. Set "Transverter function" to ON.

[MENU] » **SET > Function > Transverter Function**

5. Set "Transverter Offset." (Example: 94.000)

[MENU] » **SET > Function > Transverter Offset**



- The offset frequency (94.000) set in this item is added to the operating frequency (50.000.00) to operate the 144 MHz band transverter.

① The first digit "1" is not displayed.

Therefore, 144 MHz is displayed as "44.000.000."

6. To close the FUNCTION screen, push **[EXIT]** several times.

Displayed while the Transverter function is ON.

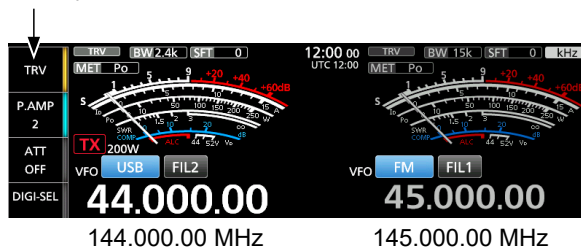

7. Rotate **(MAIN DIAL)** to set the frequency.

DPD function

SSB and AM modes

The Digital Pre-Distortion (DPD) function reduces the distortion of the SSB, SSB-D, AM, or AM-D mode signals transmitted by the transceiver.

When the transceiver is used as an exciter for the IC-PW2, the distortion generated by the RF power amplifier is also reduced.

◇ How to use the DPD function

There are 2 ways to use the DPD function:

- **Use only with the transceiver**

This also applies when the IC-PW2 is connected, but the linear amplifier circuit is OFF.

- **Use when operating the transceiver as an exciter for the IC-PW2**

When the IC-PW2 is connected, and the linear amplifier circuit is ON.

◇ Before using the DPD function

- **Use the DPD function only with the transceiver:**

The DPD single adjustment* (Adjustment only with the transceiver) is finished at the factory. The DPD function can be used without the adjustment.

* By adjusting the ALC circuit voltage and gain in the FPGA, sudden changes in the gain of the ALC circuit behind the FPGA can be minimized, enabling optimal distortion correction.

TIP: When the DPD single adjustment is required

The DPD adjustment is completed at the factory but may shift due to changes in characteristics over time.

When the linked adjustment cannot be performed, perform the single adjustment.

To perform the single adjustment:

- Connect a dummy load with sufficient input power capacity to the transceiver's antenna connector.
 - ① When the antenna SWR is 1:1.5 or higher, the DPD adjustment may not be possible.
- The transceiver's internal antenna tuner must be turned OFF.
- If the IC-PW2 is connected, disconnect it.

- **Use the DPD function when the transceiver is used as an exciter of the IC-PW2:**

The DPD linked adjustment (Adjustment linked with the IC-PW2) for each operating band is required.

① When replacing the IC-PW2, the linked adjustment is required again.

To perform the linked adjustment:

- Link the transceiver to the IC-PW2 with the ALC adjustment.
 - ① If the IC-PW2's ALC adjustment is not completed or the transceiver's DPD single adjustment is incorrect, the DPD linked adjustment cannot be performed.
- Connect a dummy load with sufficient input power capacity to the IC-PW2's antenna connector.
 - ① When the antenna SWR of the transceiver or the IC-PW2 is 1:1.5 or higher, you might not be able to make the DPD linked adjustment.
- Connect the transceiver to the IC-PW2 with the optional OPC-2501 COAXIAL CABLE FOR DPD FEEDBACK when performing the DPD linked adjustment or using the DPD function.
 - ① See the IC-PW2's instruction manual for details.

DPD function

◇ About the DPD ADJUSTMENT screen

To open the DPD ADJUSTMENT screen, select “DPD Adjustment” in the SET mode.

MENU » **SET > DPD Adjustment**

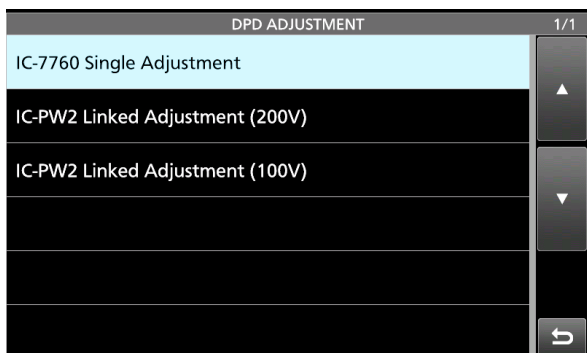

IC-7760 Single Adjustment

Displays the screen for selecting the band for the DPD single adjustment and checking the adjustment status of each band is displayed.

① When using the DPD function only with the transceiver, the function can be used in factory-adjusted conditions.

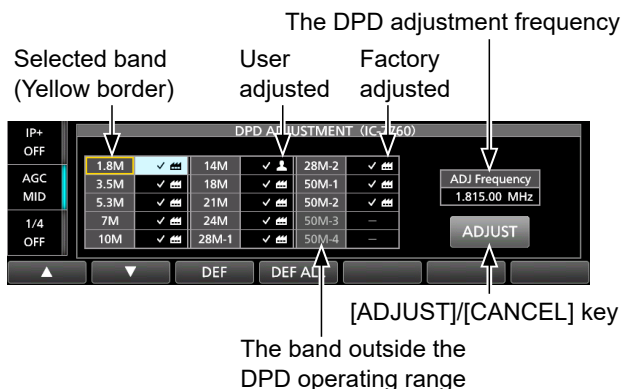

① The band outside the DPD operating range differs, depending on the transceiver version.

IC-PW2 Linked Adjustment (200V)

Displays the screen for selecting the band for the DPD linked adjustment with the IC-PW2 at 180 ~ 264 V AC and checking the adjustment status of each band at 1 kW or 500 W output is displayed.

- ① The adjustment starts at the maximum output power selected on the IC-PW2.
- ① If the IC-PW2 is not connected, the previous DPD linked adjustment status will be displayed.
- ① If the DPD linked adjustment cannot be performed, the DPD single adjustment is required.

IC-PW2 Linked Adjustment (100V)

Displays the screen for selecting the band for the DPD linked adjustment with the IC-PW2 at 90 ~ 132 V AC and checking the adjustment status of each band at 500 W output is displayed.

- ① If the IC-PW2 is not connected, the previous DPD linked adjustment status will be displayed.
- ① If the DPD linked adjustment cannot be performed, the DPD single adjustment is required.

Example: The DPD ADJUSTMENT (IC-PW2 200V) screen

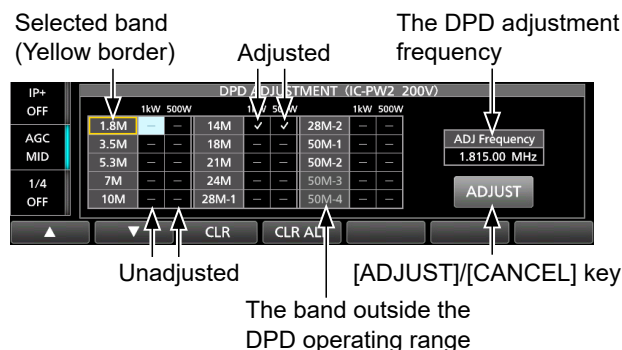

① The band outside the DPD operating range differs, depending on the transceiver version.

DPD function

◇ DPD single adjustment

Perform the user adjustment for the operating band used with the DPD function.

① To return to the factory-adjusted values, delete the user adjustment values.

1. Open the DPD ADJUSTMENT screen.

MENU » **SET > DPD Adjustment**

2. Touch “IC-7760 Single Adjustment.”
 - “Adjusted in the factory. Open the Adjustment screen and customize it?” is displayed.
3. Touch [Yes].
 - The DPD ADJUSTMENT (IC-7760) screen is displayed.
4. Touch [▲] or [▼] to select the operating band to perform the DPD single adjustment. (Example: 14M)

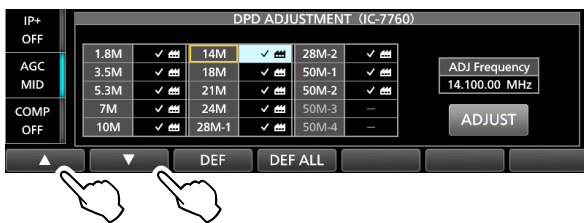

- The DPD adjustment frequency is displayed, and the operating mode is automatically switched to the appropriate one.

① While making the adjustment, changing the operating frequency or switching the antenna connector does not affect the adjustment value. See “About the DPD adjustment frequency range” for frequency changes.

5. Set the antenna connector to the one that the dummy load is connected to.

6. Touch [ADJUST].



- “Start the adjustment.” is displayed.
7. Touch [OK].
 - The transmission automatically starts at maximum output power and continues for up to 60 seconds.
 - ① When the transmit output power is low, “Transmit at 200 W RF POWER?” is displayed. Touch [Yes] to start transmission.
 - ① While transmitting, [ADJUST] changes to [CANCEL].
 - ① “The adjustment has been completed.” is displayed, and **✓** is displayed in the selected band.
 8. When the user adjustment is required for multiple bands, repeat steps 4 to 7 to adjust all the bands.

2 ADVANCED OPERATIONS

DPD function

◇ DPD linked adjustment

Follow the steps below to perform the DPD linked adjustment with the IC-PW2.

① When the single adjustment is performed after the linked adjustment is finished or returns to the factory adjustment value, readjustment will be required.

1. When the IC-PW2 is connected to a 180 ~ 264 V AC power source, switch to the maximum output power (1 kW or 500 W) for the adjustment. (Example: 1 kW)

2. Open the DPD ADJUSTMENT screen.

MENU » **SET > DPD Adjustment**

3. Touch “IC-PW2 Linked Adjustment (200V).”

• “Open the Adjustment screen?” is displayed.

① When IC-PW2 is connected to a 90 ~ 132 V AC power source, touch “IC-PW2 Linked Adjustment (100V).”

4. Touch [Yes].

• The DPD ADJUSTMENT (IC-PW2 200V) screen is displayed.

5. Touch [▲] or [▼] to select the operating band to perform the DPD linked adjustment. (Example: 14M)



• The DPD adjustment frequency is displayed, and the operating mode is automatically switched to the appropriate one.

① Check that the selected frequency and band are synchronized with the IC-PW2.

① While making the adjustment, changing the operating frequency or switching the antenna connector does not affect the adjustment value.

6. Set the transceiver’s antenna connector to the one connected to the IC-PW2’s RF input connector on the side that **TX** is displayed.

7. Switch the IC-PW2’s antenna connector to the one connected to the dummy load.

8. Touch [ADJUST].

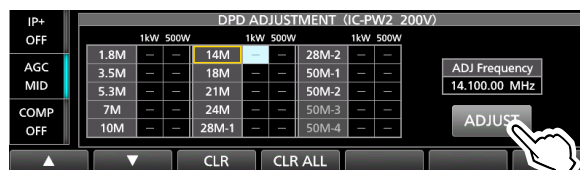

• The confirmation dialog is displayed.

9. Touch [Yes].

• “Transmit at 1 kW output power?” is displayed.

10. Touch [OK].

• The exciter automatically starts transmitting.

① While transmitting, [ADJUST] changes to [CANCEL].

① “The adjustment has been completed.” is displayed, and is displayed in the selected band.

11. Repeat steps 5 to 10 to adjust all the bands used with the DPD function.

2 ADVANCED OPERATIONS

DPD function

◇ Clearing the DPD adjustment value

You can clear the DPD adjustment value in each adjustment screen.

- ① The deletion range differs, depending on each screen.
- ① Even if the IC-PW2 is not connected, the DPD linked adjustment value can be cleared.

To clear all the DPD single adjustment values and the DPD linked adjustment values (100V/200V):

Touch the following keys on the DPD ADJUSTMENT (IC-7760) screen.



| Key | Action |
|---------|---|
| ▲/▼ | Selects the band. ① Usable only when the [DEF] key is pushed. |
| DEF | Clears all the DPD single adjustment values and the DPD linked adjustment values (100V/200V, at 1 kW and 500 W output) registered in the selected band. |
| DEF ALL | Clears all the DPD single adjustment values and the DPD linked adjustment values (100V/200V, at 1 kW and 500 W output) registered in all bands. |

To clear only the DPD linked adjustment value (200V):

Touch the following keys on the DPD ADJUSTMENT (IC-PW2 200V) screen.

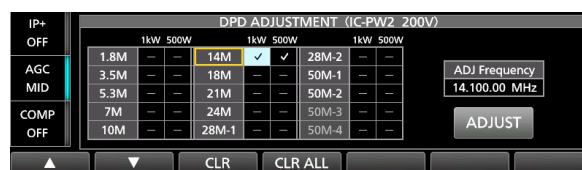

| Key | Action |
|---------|---|
| ▲/▼ | Selects the band. ① Usable only when the [CLR] key is pushed. |
| CLR | Clears all the DPD linked adjustment values (200V, at 1 kW and 500 W output) registered in the selected band. |
| CLR ALL | Clears all the DPD linked adjustment values (200V, at 1 kW and 500 W output) registered in all bands. |

To clear only the DPD linked adjustment value (100V):

Touch the following keys on the DPD ADJUSTMENT (IC-PW2 100V) screen.

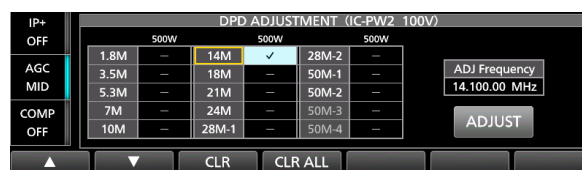

| Key | Action |
|---------|--|
| ▲/▼ | Selects the band. ① Usable only when the [CLR] key is pushed. |
| CLR | Clears the DPD linked adjustment values (100V, at 500 W output) registered in the selected band. |
| CLR ALL | Clears all the DPD linked adjustment values (100V, at 500 W output) registered in all bands. |

2 ADVANCED OPERATIONS

DPD function

◇ Turning the DPD function ON or OFF SSB, SSB-D, AM, and AM-D modes

Turn the DPD function ON or OFF in the operating band.

1. Select the operating mode. (Example: USB)
2. Push **[FUNCTION]**.
 - Opens the FUNCTION screen.
3. Touch **[DPD]**.



- ① Touching **[DPD]** turns the DPD function ON or OFF.

NOTE:

- Even if the IC-PW2 is connected, the function can be turned ON or OFF only by touching **[DPD]** on the transceiver's screen.
- The function is fixed to OFF when:
 - An unadjusted band for the function is selected.
 - An operating mode other than SSB, SSB-D, AM, or AM-D is selected.
- Even if the adjusted band for the function is selected, the function is fixed to OFF when the operating frequency is outside the DPD adjustment frequency range.
- When the DPD function is turned ON, feedback correction is performed while monitoring the transceiver's transmit signal level. Adjust the microphone gain to a level that does not exceed the ALC zone of the meter. Otherwise, an abnormality in the correction value is detected, and the feedback correction will be stopped.

◇ About the DPD adjustment frequency range

The following table shows the DPD adjustment frequency range for each frequency band. When changing the DPD adjustment frequency, select it within the transmission frequency range listed in the specifications of the exciter's manual.

- ① Even if the exciter's band edge is changed, the frequency range is the same as in the table.
② The usable frequency band differs, depending on the transceiver version.

| Frequency Band | Frequency range |
|----------------|-------------------------|
| 1.8 MHz | 0.030.000 ~ 1.999.999 |
| 3.5 MHz | 2.000.000 ~ 3.999.999 |
| 5.3 MHz | 4.000.000 ~ 5.799.999 |
| 7 MHz | 5.800.000 ~ 7.999.999 |
| 10 MHz | 8.000.000 ~ 11.999.999 |
| 14 MHz | 12.000.000 ~ 14.999.999 |
| 18 MHz | 15.000.000 ~ 18.999.999 |
| 21 MHz | 19.000.000 ~ 21.999.999 |
| 24 MHz | 22.000.000 ~ 24.999.999 |
| 28 MHz-1 | 25.000.000 ~ 28.999.999 |
| 28 MHz-2 | 29.000.000 ~ 29.999.999 |
| 50 MHz-1 | 30.000.000 ~ 50.999.999 |
| 50 MHz-2 | 51.000.000 ~ 52.000.000 |
| 50 MHz-3 | 52.000.001 ~ 52.999.999 |
| 50 MHz-4 | 53.000.000 ~ 60.000.000 |

About the 5 MHz frequency band operation (For USA version)

Operation on the 5 MHz frequency band is allowed on 5 discrete frequencies, and you must adhere to the following:

- Only use the USB, USB Data, PSK, and CW modes.
- Maximum of 100 watts ERP (Effective Radiated Power)
- Maximum 2.8 kHz bandwidth

It is your responsibility to set all controls so that transmission in this frequency band meets the stringent conditions under which amateur operations may use these frequencies.

TIP: We recommend that you save these frequencies, modes, and filter settings into memory channels, for easy recall.

NOTE: To assist you in operating within the rules specified by the FCC, the transmission is illegal on any frequencies other than the five shown in the tables on the right.

For the USB and USB data modes:

The FCC specifies center frequencies on the 5 MHz frequency band. However, the transceiver displays carrier frequency. Therefore, tune the transceiver 1.5 kHz below the specified FCC channel center frequency.

| Transceiver displayed frequency | FCC channel center frequency |
|---------------------------------|------------------------------|
| 5.33050 MHz | 5.33200 MHz |
| 5.34650 MHz | 5.34800 MHz |
| 5.35700 MHz | 5.35850 MHz |
| 5.37150 MHz | 5.37300 MHz |
| 5.40350 MHz | 5.40500 MHz |

For the CW and PSK modes:

The transceiver displays the center frequency. Therefore, tune the transceiver to the specified FCC channel frequency when you operate in these modes.

| Transceiver displayed frequency | FCC channel center frequency |
|---------------------------------|------------------------------|
| 5.33200 MHz | 5.33200 MHz |
| 5.34800 MHz | 5.34800 MHz |
| 5.35850 MHz | 5.35850 MHz |
| 5.37300 MHz | 5.37300 MHz |
| 5.40500 MHz | 5.40500 MHz |

Section 3

SCOPE OPERATION (ADVANCED)

| | |
|--|-----|
| Spectrum scope screen..... | 3-2 |
| ◇ Setting the Center Mode span..... | 3-2 |
| ◇ Setting the Fixed Mode range | 3-2 |
| ◇ Using the Scroll mode | 3-3 |
| ◇ Directly selecting a frequency | 3-4 |
| ◇ Displaying the Dual Scope screen | 3-4 |
| ◇ Adjusting the sweep speed | 3-5 |
| ◇ Adjusting the Reference level..... | 3-5 |
| SCOPE SET screen | 3-6 |
| Audio scope screen..... | 3-9 |
| ◇ Using the Audio Scope | 3-9 |
| ◇ AUDIO SCOPE SET screen..... | 3-9 |

3 SCOPE OPERATION (ADVANCED)

Spectrum scope screen

◇ Setting the Center Mode span

Displays signals around the operating frequency within the selected span. The operating frequency is always displayed in the center of the screen.

1. Display the SPECTRUM SCOPE screen.
MENU » **SCOPE**
2. Touch [CENT/FIX] to select the Center mode.
 ① Touch [CENT/FIX] to toggle between the Center and Fixed modes.
3. Touch [SPAN] several times until the desired scope span is selected.
 - Selectable span:
 ± 2.5 kHz, ± 5.0 kHz, ± 10 kHz, ± 25 kHz, ± 50 kHz, ± 100 kHz, ± 250 kHz, ± 500 kHz
 - ① Touch [SPAN] for 1 second to select the ± 2.5 kHz span (minimum).

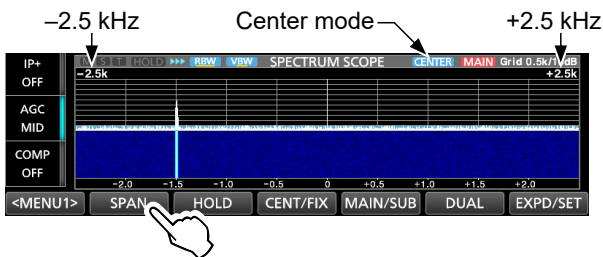

◇ Setting the Fixed Mode range

Displays signals within a specified frequency range. The selected frequency band activity can easily be observed in this mode.

Four Fixed Edge bands can be set for each amateur frequency band covered by the transceiver in the SCOPE SET screen.

1. Display the SPECTRUM SCOPE screen.
MENU » **SCOPE**
2. Touch [CENT/FIX] to select the Fixed mode.
 ① Touch [CENT/FIX] to toggle between the Center and Fixed modes.
3. Touch [EDGE] several times to select the Edge frequency.

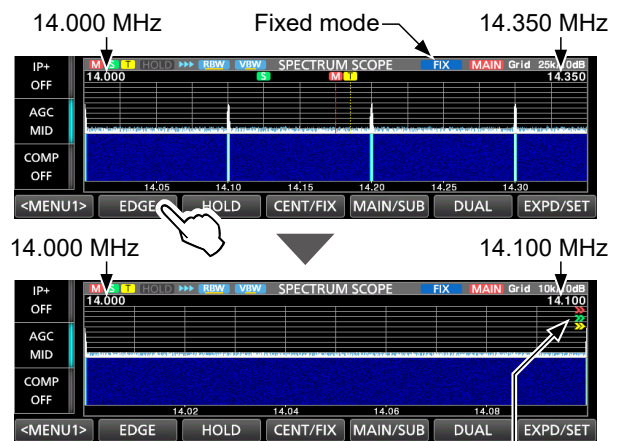

“>>” shows that the operating frequency is out of the fixed Edge frequency.

- ① When the operating frequency moves outside of the set lower or upper Edge frequency, “<<” or “>>” is displayed in the upper side corners of the SPECTRUM SCOPE screen.
 - <<: The frequency is outside the lower edge.
 - >>: The frequency is outside the higher edge.
 When the frequency goes further away, “Scope Out of Range” is displayed.
- ① When scrolling out of, or back into the selected Fixed Edges, a beep sounds.

3 SCOPE OPERATION (ADVANCED)

Spectrum scope screen

◇ Using the Scroll mode

Displays signals within a selected span. When the operating frequency moves outside of the screen, the displayed frequency range automatically scrolls.

1. Display the SPECTRUM SCOPE screen.

MENU » **SCOPE**

2. Touch [CENT/FIX] for 1 second to select the Scroll mode.
 - When changing the Center mode to the Scroll mode, "SCROLL-C" is displayed. You can change the scope span by touching [SPAN].
 - When changing the Fixed mode to the Scroll mode, "SCROLL-F" is displayed. You can change the Edge frequencies by touching [EDGE].
3. Touch [CENT/FIX] to return to the previous mode.
 - When returning to the Center mode, the scope span does not return to the previous setting.
 - When returning to the Fixed mode, the Edge frequencies return to the last selected "Fixed Edges." If the operating frequency is below the lower Edge frequency, or above the upper Edge frequency, "<<" or ">>" is displayed in the upper side corners of the SPECTRUM SCOPE screen.

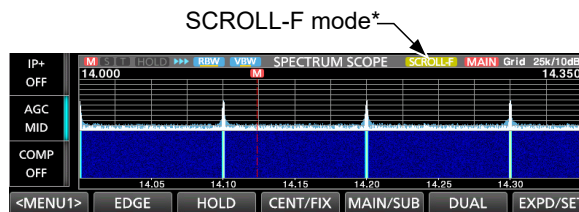

* When in the SCROLL-C mode, **SCROLL-C** is displayed.

3 SCOPE OPERATION (ADVANCED)

Spectrum scope screen

◇ Directly selecting a frequency

By touching or clicking on the FFT scope zone or the waterfall zone in the SPECTRUM SCOPE screen, you can directly tune your frequency to the signal.

1. Display the SPECTRUM SCOPE screen.

MENU » **SCOPE**

2. Touch the signal spectrum on the FFT scope zone or the waterfall zone or click on a signal. (Example: in the Center mode)

3. **When you touch the FFT scope zone or the waterfall zone, the area around the touched point is zoomed in.**

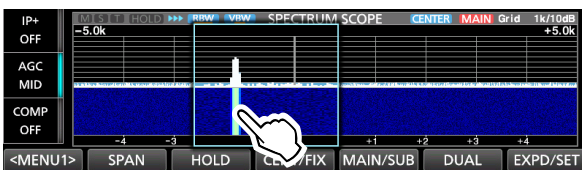
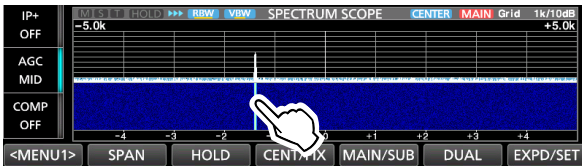

Touch the signal in the zoomed area.

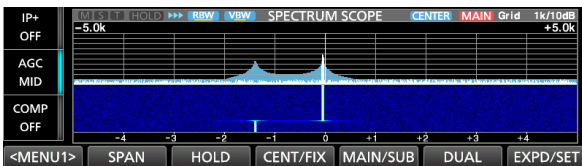

- ① Touch out of the zoomed area to close the zoomed window.

If you click on a signal, your frequency is tuned to the signal frequency.

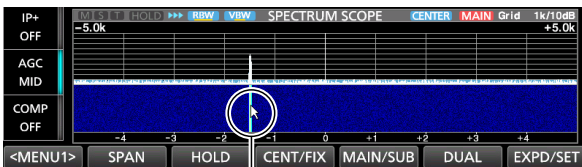

Click on the frequency.

Your frequency is tuned to the signal frequency.

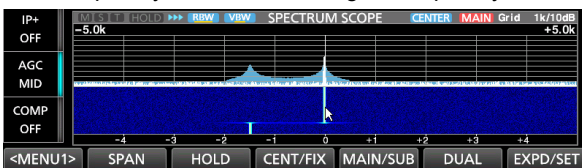

TIP: When using a wired mouse

- While right-clicking on the screen, the frequency where the cursor is located is displayed.
- By right-clicking and dragging the cursor, the frequency changes. Release to return to the originally selected frequency.
- By clicking and dragging the cursor, the frequency changes to that where the cursor is released.

◇ Displaying the Dual Scope screen

The transceiver has a Dual scope mode that simultaneously displays the Main and Sub band scopes during Dualwatch operation.

1. Display the SPECTRUM SCOPE screen.

MENU » **SCOPE**

2. Touch [DUAL].

- ① Touching [DUAL] toggles between Dual scope and Single scope.

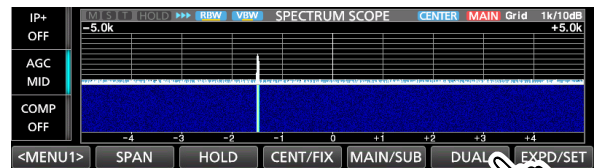

The selected scope is framed in orange.



The Sub band scope is selected.

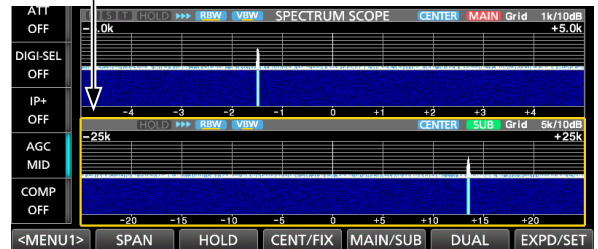

- ① Touching or clicking the scope that is not framed in orange selects the Main band or Sub band scope.

- ① You can select the scope display type in the following item.

MENU » **SCOPE > EXPD/SET > Dual Scope Type**

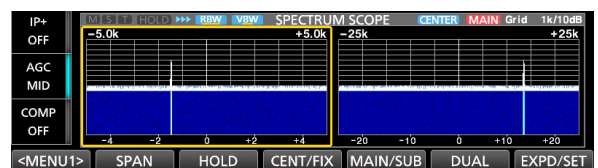

Example: "Side by Side"

- ① You can also set the Dual Scope Auto Select item not to change the operating band (Main/Sub) when the frequency is touched or clicked.

MENU » **SCOPE > EXPD/SET > Dual Scope Auto Select**

3 SCOPE OPERATION (ADVANCED)

Spectrum scope screen

◇ Adjusting the sweep speed

Select the sweep speed to change the FFT scope refresh speed and the waterfall speed.

- ① To change only the waterfall speed, select “Slow,” “Mid,” or “Fast” in the Waterfall Speed.
- ① With dual scopes displayed, touch the scope you want to set. It will be framed in orange.

1. Display the SPECTRUM SCOPE screen.

MENU » **SCOPE**

2. Touch [**< MENU1 >**] to display MENU 2.

3. Touch [**SPEED**] several times until the desired sweep speed is selected.

- Selectable speeds: FAST, MID, or SLOW
- ① “>>>,” “>>,” or “>” indicates FAST, MID, or SLOW.
- ① A popup window is displayed in the center of the SPECTRUM SCOPE screen and displays the selected sweep speed for 1 second.

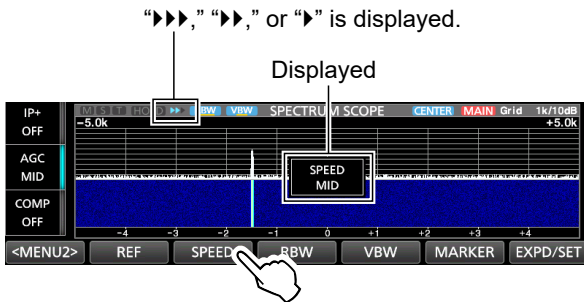

◇ Adjusting the Reference level

When monitoring a weak signal that is buried in the noise floor, or monitoring a strong signal but some stronger signals are nearby, adjusting the Reference level of the screen helps you to see these signals.

- Even if this setting is changed, it does not affect the input signal level.
- When you adjust the Reference level, the signal strength for the waterfall also appears to change.
- ① Each band memorizes the setting.

1. Display the SPECTRUM SCOPE screen.

MENU » **SCOPE**

2. Touch [**< MENU1 >**] to display MENU 2.

3. Touch [**REF**].

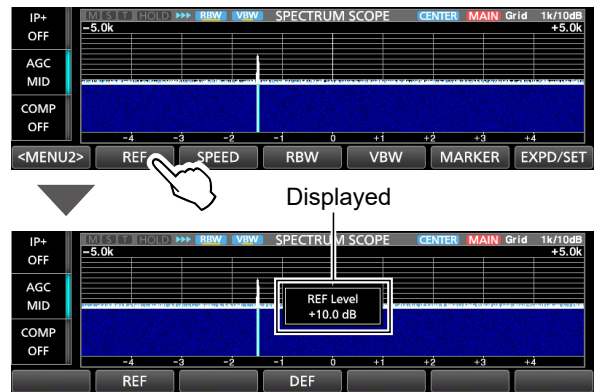

4. Rotate **(MAIN DIAL)** to adjust the level.

- Adjustable range: $-30.0\text{ dB} \sim +10.0\text{ dB}$
- ① You can reset to the $\pm 0.0\text{ dB}$ default value by touching [**DEF**] for 1 second.

5. To close the REF Level window, touch [**REF**].

The difference in the spectrum

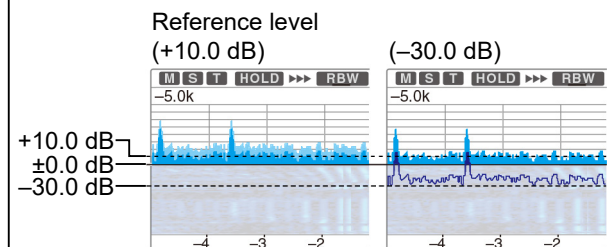

- ① If you adjust this setting to a positive level, all signal levels appear stronger. Or, if you adjust to a negative level, all signal levels appear weaker.

3 SCOPE OPERATION (ADVANCED)

SCOPE SET screen

This screen is used to set the waveform color, Scope range for the Fixed and Scroll-F modes, and other settings.

1. Display the SPECTRUM SCOPE screen.

MENU » **SCOPE**

2. Touch [EXPD/SET] for 1 second.
3. Touch the item to set. (Example: Max Hold)

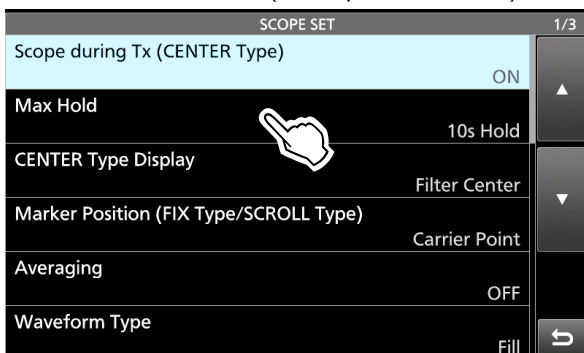

4. Touch the option to set. (Example: ON)

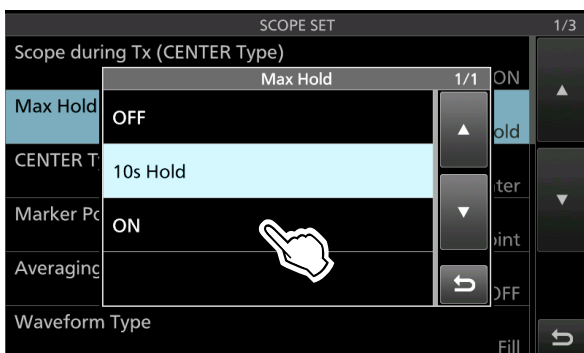

① See to the right for details on the setting items and their options.

5. To close the SCOPE SET screen, push **EXIT**.

TIP: You can set each item to its default by touching the item for 1 second, and then touching “Default” on the QUICK MENU screen.

Scope during Tx (CENTER Type) (Default: ON)

Turns the TX signal display ON or OFF.

Max Hold (Default: 10s Hold)

Selects the Peak Level Holding function.

- OFF: Turns OFF the Peak Level Holding function.
- 10s Hold: Holds the peak spectrum for 10 seconds.
- ON: Continuously holds the peak spectrum.

CENTER Type Display (Default: Filter Center)

Selects the center frequency of the SPECTRUM SCOPE screen. (Only in the Center mode)

- Filter Center: Displays the selected filter’s center frequency in the center of the SPECTRUM SCOPE screen.
- Carrier Point Center: Displays the carrier point frequency of the selected operating mode in the center of the SPECTRUM SCOPE screen.
- Carrier Point Center (Abs. Freq.): In addition to the carrier point center setting above, the actual frequency is displayed at the bottom of the scope.
① Abs. Freq. : Absolute Frequency

Marker Position (FIX Type/SCROLL Type)

(Default: Carrier Point)

Selects the marker position on the SPECTRUM SCOPE screen. (Only in the Fixed or Scroll mode)

- Filter Center: Displays the Marker on the selected filter’s center frequency.
- Carrier Point: Displays the Marker on the carrier point frequency of the selected operating mode.

Averaging (Default: OFF)

Sets the FFT scope Waveform Averaging function to between 2 and 4, or OFF.

- OFF: The FFT scope screen refreshes on each sweep. This setting displays the critical spectrum view.
- 2, 3, 4: The FFT scope screen averages 2 to 4 sweeps to smoothly display the spectrum.

Waveform Type (Default: Fill)

Selects the outline waveform display for the FFT scope screen.

- Fill: Displays only the waveform, in color.
- Fill+Line: Displays both the waveform and the outline, in color.

3 SCOPE OPERATION (ADVANCED)

SCOPE SET screen

Waveform Color (Current) (Default: (R) 217 (G) 241 (B) 247)

Sets the waveform color for the currently received signals.

- ① Touch and select the R (Red), G (Green), or B (Blue) scale, and then rotate **(MULTI)** to adjust the level from 0 to 255.
- ① The color is displayed in the box above the RGB scale.

Waveform Color (Line) (Default: (R) 70 (G) 30 (B) 0)

Sets the waveform outline color for the currently received signals.

- ① Touch and select the R (Red), G (Green), or B (Blue) scale, and then rotate **(MULTI)** to adjust the level from 0 to 255.
- ① The color is displayed in the box above the RGB scale.

Waveform Color (Max Hold) (Default: (R) 58 (G) 110 (B) 147)

Sets the waveform color for the received signals maximum level.

- ① Touch and select the R (Red), G (Green), or B (Blue) scale, and then rotate **(MULTI)** to adjust the level from 0 to 255.
- ① The color is displayed in the box above the RGB scale.

Waterfall Display (Default: ON)

Turns the Waterfall display ON or OFF for the Normal scope and the Mini scope screens.

- ① On the Expanded scope screen, the Waterfall is always displayed.
- OFF: Turns OFF the Waterfall display.
- ON: Turns ON the Waterfall display.

Waterfall Speed (Default: Mid)

Selects the Waterfall speed.

- Slow: Sets the Waterfall speed to Slow.
- Mid: Sets the Waterfall speed to Mid.
- Fast: Sets the Waterfall speed to Fast.

Waterfall Size (Expand Screen) (Default: Mid)

Selects the Waterfall height in the Expand scope screen.

- Small: The same height as the Normal scope screen, only the FFT scope expands.
- Mid: The Waterfall height expands at the same ratio as the FFT scope.
- Large: Only the Waterfall height expands.

Waterfall Peak Color Level (Default: Grid 10)

Selects the signal level that the Waterfall displays a peak color.

Higher signal levels are Red, Yellow, Green, Light-blue, Blue, and Black, in that order.

- Select between Grid 1 and Grid 10.

Waterfall Marker Auto-hide (Default: ON)

Turns the Waterfall Marker Auto-hide function ON or OFF.

- OFF: The marker in the Waterfall zone stays ON.
- ON: The marker in the Waterfall zone is hidden 2 seconds after it stops in place.

Dual Scope Type (Default: Over/Under)

When the Dual scope is selected, select the Main and Sub scope layout.

- Over/Under: Displays the Main scope over the Sub scope.
- Side by Side: Displays the Main and Sub scopes side by side.

Dual Scope Auto Select (Default: ON)

When the Dual scope is selected, by selecting the band (Main or Sub) simultaneously switches the Main or Sub scope.

- OFF: The Main scope and Sub scope are not switched by selecting the Main band or Sub band.
- ON: The Main scope and Sub scope are switched by selecting the Main band or Sub band.

3 SCOPE OPERATION (ADVANCED)

SCOPE SET screen

Fixed Edges

0.03 – 1.60 (Default: No.1 0.500–1.500 MHz)
 (Default: No.2 0.500–1.500 MHz)
 (Default: No.3 0.500–1.500 MHz)
 (Default: No.4 0.500–0.550 MHz)

Sets the Upper and Lower Edge frequencies in the Fixed and the Scroll-F modes. Four edges are assigned to each band.

NOTE:

- First set the lower Edge frequency.
- Set the upper Edge frequency within 50 MHz of the lower frequency.

- Settable range: 0.030 ~ 1.600 MHz

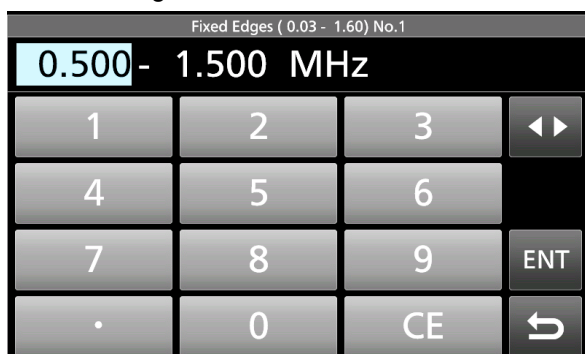

① Touch **↔** to select the upper and lower edge frequency, and then rotate **⊕MULTI** or touch the keypad to edit the frequency.

1.60 – 2.00 (Default: No.1 1.800–2.000 MHz)
 (Default: No.2 1.800–1.830 MHz)
 (Default: No.3 1.900–1.930 MHz)
 (Default: No.4 1.800–1.850 MHz)

- Settable range: 1.600 ~ 2.000 MHz

2.00 – 6.00 (Default: No.1 3.500–4.000 MHz)
 (Default: No.2 3.500–3.575 MHz)
 (Default: No.3 3.750–3.850 MHz)
 (Default: No.4 3.500–3.550 MHz)

- Settable range: 2.000 ~ 6.000 MHz

6.00 – 8.00 (Default: No.1 7.000–7.300 MHz)
 (Default: No.2 7.000–7.030 MHz)
 (Default: No.3 7.030–7.200 MHz)
 (Default: No.4 7.000–7.050 MHz)

- Settable range: 6.000 ~ 8.000 MHz

8.00 – 11.00 (Default: No.1 10.100–10.150 MHz)
 (Default: No.2 10.100–10.130 MHz)
 (Default: No.3 10.130–10.150 MHz)
 (Default: No.4 10.100–10.150 MHz)

- Settable range: 8.000 ~ 11.000 MHz

11.00 – 15.00 (Default: No.1 14.000–14.350 MHz)
 (Default: No.2 14.000–14.100 MHz)
 (Default: No.3 14.100–14.350 MHz)
 (Default: No.4 14.000–14.050 MHz)

- Settable range: 11.000 ~ 15.000 MHz

15.00 – 20.00 (Default: No.1 18.068–18.168 MHz)
 (Default: No.2 18.068–18.110 MHz)
 (Default: No.3 18.110–18.168 MHz)
 (Default: No.4 18.000–18.050 MHz)

- Settable range: 15.000 ~ 20.000 MHz

20.00 – 22.00 (Default: No.1 21.000–21.450 MHz)
 (Default: No.2 21.000–21.150 MHz)
 (Default: No.3 21.150–21.450 MHz)
 (Default: No.4 21.000–21.050 MHz)

- Settable range: 20.000 ~ 22.000 MHz

22.00 – 26.00 (Default: No.1 24.890–24.990 MHz)
 (Default: No.2 24.890–24.930 MHz)
 (Default: No.3 24.930–24.990 MHz)
 (Default: No.4 24.900–24.950 MHz)

- Settable range: 22.000 ~ 26.000 MHz

26.00 – 30.00 (Default: No.1 28.000–29.000 MHz)
 (Default: No.2 28.000–28.200 MHz)
 (Default: No.3 28.200–29.000 MHz)
 (Default: No.4 28.000–28.100 MHz)

- Settable range: 26.000 ~ 30.000 MHz

30.00 – 45.00 (Default: No.1 30.000–31.000 MHz)
 (Default: No.2 30.000–31.000 MHz)
 (Default: No.3 30.000–31.000 MHz)
 (Default: No.4 30.000–30.100 MHz)

- Settable range: 30.000 ~ 45.000 MHz

45.00 – 60.00 (Default: No.1 50.000–51.000 MHz)
 (Default: No.2 50.000–50.100 MHz)
 (Default: No.3 50.100–50.300 MHz)
 (Default: No.4 50.000–50.100 MHz)

- Settable range: 45.000 ~ 60.000 MHz

Audio scope screen

The Audio scope enables you to display the received signal's frequency component on the FFT scope, and its waveform components on the Oscilloscope. The FFT scope also has a waterfall.

• AUDIO SCOPE screen

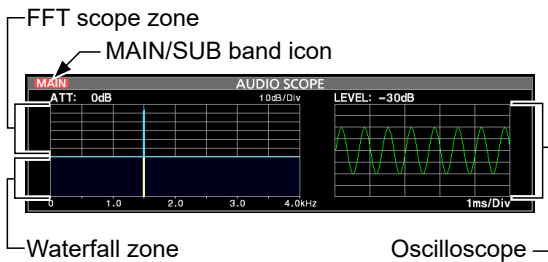

◇ Using the Audio Scope

Display the AUDIO SCOPE screen.

MENU » **AUDIO**

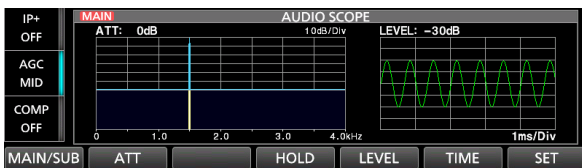

| Key | Action | |
|----------|--|--|
| MAIN/SUB | Selects the Main or Sub band. | |
| ATT | Touch | Selects the attenuator for the FFT scope. • 0 (OFF), 10, 20, or 30 dB |
| | Touch for 1 second | Turns OFF the attenuator. (0 dB) |
| HOLD | Turns the Hold function ON or OFF. • HOLD is displayed and freezes the current audio spectrum. | |
| LEVEL | Selects the Oscilloscope level. • 0, -10, -20, or -30 dB | |
| TIME | Selects the Oscilloscope sweep time. • 1, 3, 10, 30, 100, or 300 ms/Div | |
| SET | Displays the AUDIO SCOPE SET screen. | |

◇ AUDIO SCOPE SET screen

This screen is used to set the FFT scope waveform type, color, Waterfall display, and oscilloscope waveform color.

1. Display the AUDIO SCOPE screen.
MENU » **AUDIO**
2. Touch [SET].
3. Touch the item to set.
(Example: FFT Scope Waveform Type)

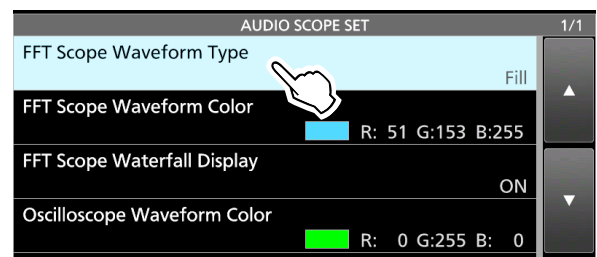

4. Touch the option to set.
① See below for details on the setting items and their options.
5. To close the AUDIO SCOPE SET screen, push **EXIT**.

TIP: You can set each item to its default by touching the item for 1 second, and then touching "Default" on the QUICK MENU screen.

FFT Scope Waveform Type (Default: Fill)

Selects the type of waveform for the FFT scope.

- Line: Only the waveform outline is drawn.
- Fill: The full waveform is drawn in color.

FFT Scope Waveform Color (Default: (R) 51 (G) 153 (B) 255)

Sets the waveform color for the FFT scope.

- ① Touch and select the R (Red), G (Green), or B (Blue) scale, and then rotate **MULTI** to adjust the level from 0 to 255.
- ① The color is displayed in the box above the RGB scale.

FFT Scope Waterfall Display (Default: ON)

Turns the Waterfall display ON or OFF.

- OFF: Turns OFF the Waterfall display.
- ON: Turns ON the Waterfall display.

Oscilloscope Waveform Color (Default: (R) 0 (G) 255 (B) 0)

Sets the waveform color for the Oscilloscope.

- ① Touch and select the R (Red), G (Green), or B (Blue) scale, and then rotate **MULTI** to adjust the level from 0 to 255.
- ① The color is displayed in the box above the RGB scale.

Section 4 SD CARD/USB FLASH DRIVE (ADVANCED)

| | |
|---|-----|
| Saving the setting data onto an SD card or USB flash drive..... | 4-2 |
| Loading the saved data files into a transceiver | 4-3 |
| Deleting a data file..... | 4-4 |
| Displaying the SD card or USB flash drive information | 4-5 |
| About the SD card and USB flash drive's folders | 4-6 |
| ◇ SD card folder | 4-6 |
| ◇ USB flash drive folder..... | 4-6 |

4 SD CARD/USB FLASH DRIVE (ADVANCED)

Saving the setting data onto an SD card or USB flash drive

The Memory channels and the transceiver's settings can be saved onto an SD card or USB flash drive.

1. Open the SAVE SETTING screen.

MENU » **SET > SD Card > Save Setting**

MENU » **SET > USB Flash Drive > Save Setting**

2. Touch "<<New File>>."

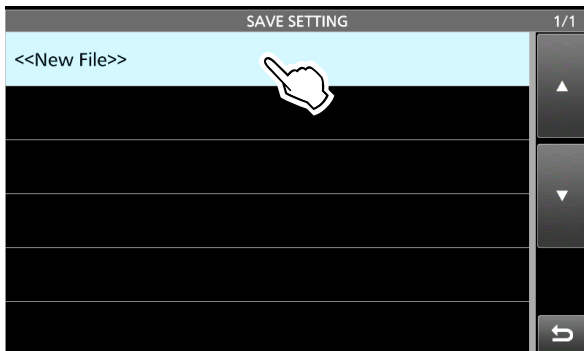

① The file name is automatically set in the following format: SetYYYYMMDD_xx (YYYY: Year, MM: month, DD: day, xx: serial number).

3. To save the file with the displayed name, touch [ENT].

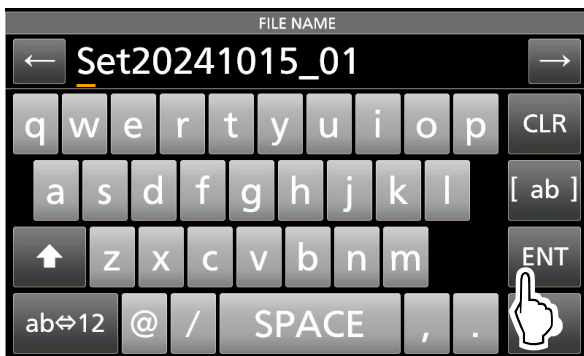

① If you want to change the name, delete the name and reenter it, and then touch [ENT].

4. Touch [YES].



- Saves the data settings.

5. To close the SD CARD or USB FLASH DRIVE screen, push **EXIT** several times.

4 SD CARD/USB FLASH DRIVE (ADVANCED)

Loading the saved data files into a transceiver

You can load the Memory channels and transceiver's settings from the SD card or USB flash drive into the transceiver.

① The transceiver has "ALL" and "Select" loading options.

TIP: Saving the current data is recommended before loading other data into the transceiver. (p. 4-2)

1. Open the LOAD SETTING screen.

MENU » **SET > SD Card > Load Setting**

MENU » **SET > USB Flash Drive > Load Setting**

2. Touch the file to load.

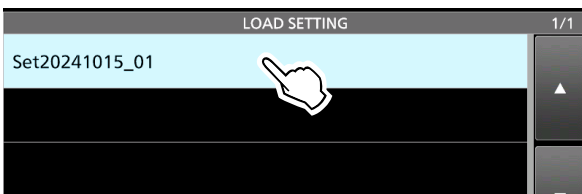

3. Touch "Select."

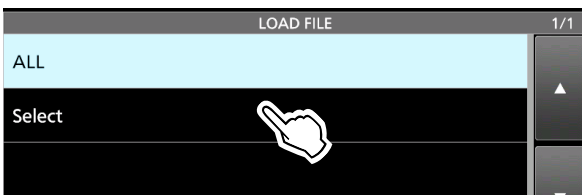

① To load all the contents on the LOAD OPTION screen, touch "ALL" and go to step 6.

4. Touch the loading options.
(Example: CI-V Address)

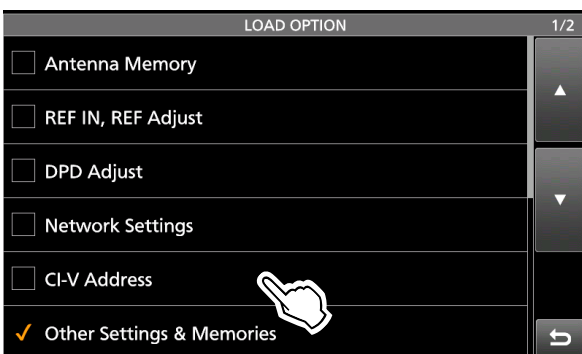

• "✓" is displayed on the left side of the selected option.

① The Set mode settings and Memory channel contents are always loaded.

5. Touch "<<Load>>."



6. Touch [YES].



① After the loading ends, "COMPLETED! Restart the IC-7760." is displayed.

① When you select "REF IN, REF Adjust" or "DPD Adjust" in step 4, the confirmation dialog is displayed.

7. Turn OFF the transceiver, then turn it ON again to restart the transceiver.

4 SD CARD/USB FLASH DRIVE (ADVANCED)

Deleting a data file

Follow the steps below to delete the files you no longer need on the SD card or the USB flash drive.

NOTE: Deleted data from a card or flash drive cannot be recalled. Before deleting any data, back up the card data onto another device.

1. Open the SAVE SETTING screen.
MENU » **SET > SD Card > Save Setting**
MENU » **SET > USB Flash Drive > Save Setting**

2. Touch the file you want to delete for 1 second.



3. Touch "Delete."

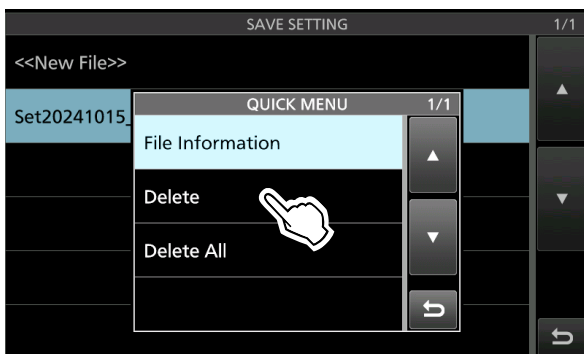

① To delete all files, touch "Delete All."

① To cancel deleting, push **EXIT**.

4. Touch [YES].

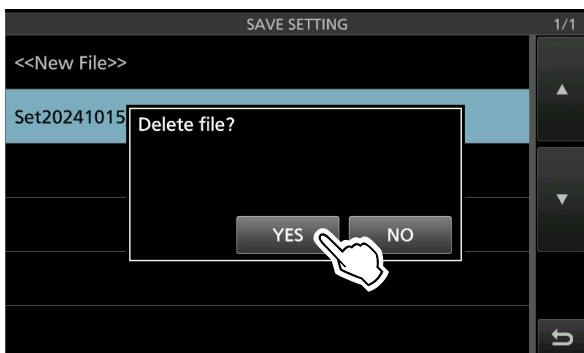

5. To close the SAVE SETTING screen, push **EXIT** several times.

TIP: Checking the file information
Touch "File Information" on the QUICK MENU screen to display the file name, size, and the saved date.

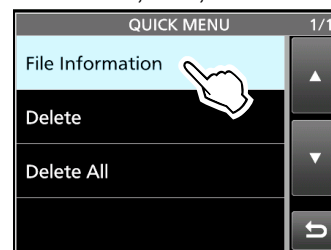

4 SD CARD/USB FLASH DRIVE (ADVANCED)

Displaying the SD card or USB flash drive information

You can display the SD card or USB flash drive capacity, and the time remaining for voice recording (SD card only).

1. Open the SD CARD or USB FLASH DRIVE screen.

MENU » **SET > SD Card**

MENU » **SET > USB Flash Drive**

2. Touch “SD Card Info” or “USB Flash Drive info.”
(Example: SD Card Info)

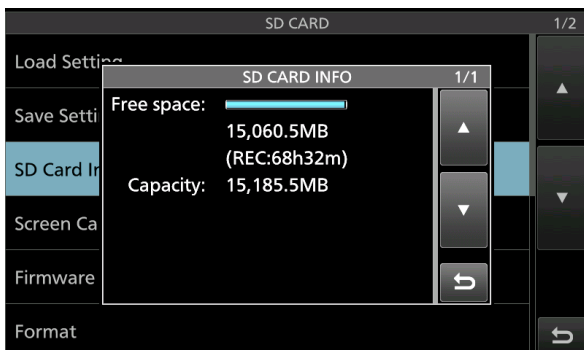
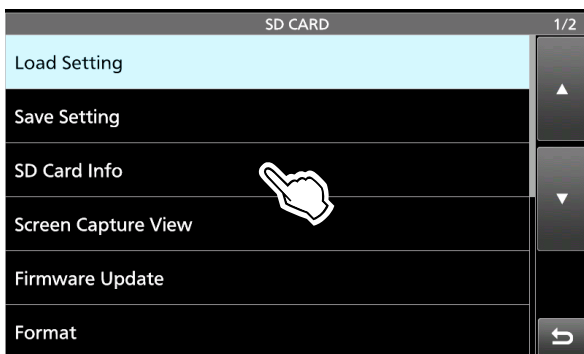

- Displays the card or flash drive's free space and capacity.
3. To close the SD CARD or USB FLASH DRIVE screen, push **EXIT** several times.

About the SD card and USB flash drive's folders

◇ SD card folder

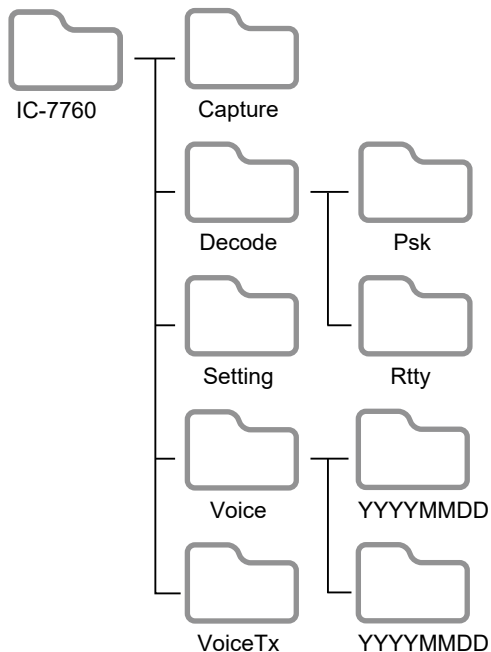

The USB flash drive contains the IC-7760 folder, Capture folder and the Setting folder.

The folder in the SD card contains the following:

- **IC-7760 folder**
The folders created in the IC-7760 are contained in this folder.
- **Capture folder**
The captured screen data in the “png” or “bmp” format.
- **Decode folder**
The RTTY and PSK decode log folder.
- **Psk folder**
The transmitted or received PSK decode log data in the “txt” or “html” format.
- **Rtty folder**
The transmitted or received RTTY decode log data in the “txt” or “html” format.
- **Setting folder**
The transceiver’s setting data in the “icf” format.
- **Voice folder**
The recorded QSO audio data folders.
- **YYYYMMDD folders**
The recorded audio file in the “wav” format. The folder name is automatically created in the following format: YYYYMMDD (YYYY: year, MM: month, DD: day)
- **VoiceTx folder**
The recorded voice audio data for the Voice TX function in the “wav” format.

◇ USB flash drive folder

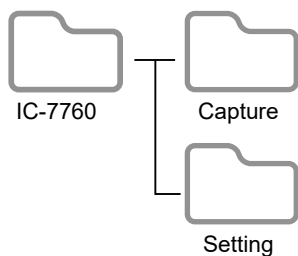

| | |
|---|-----|
| Recording a QSO audio | 5-2 |
| ◇ Using the [REC] screen | 5-2 |
| ◇ Using the QUICK MENU screen | 5-2 |
| ◇ Using the MENU screen | 5-2 |
| Playing back a QSO audio | 5-3 |
| Checking the folder or file information | 5-4 |
| Deleting files | 5-5 |
| Deleting folders | 5-5 |
| RECORDER SET screen | 5-6 |
| PLAYER SET screen | 5-7 |
| Playing back audio on a PC | 5-7 |
| Instant Replay function | 5-8 |
| ◇ Recording the Instant Replay | 5-8 |
| ◇ Playing back the Instant Replay | 5-8 |
| INSTANT REPLAY SET screen | 5-8 |

Recording a QSO audio

This transceiver is equipped with a QSO recorder not only for the receive audio but also for the transmit audio.

This function is useful to make a QSO record, or to confirm your QSO with a rare entity's station, or on a DX'pedition. You can also use the function to repeatedly transmit the same voice message.

The recorded contents are saved onto an SD card.

There are 3 ways to start recording.

- Hold down **[REC]** for 1 second.
- Push **[QUICK]** and touch “<<REC Start>>.”
- Push **[MENU]** and touch [RECORD].

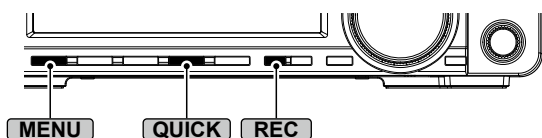

① The recorded audio is saved in the “Voice” folder on the SD card.

① When “PTT Auto REC” is set to ON, the recording automatically starts when you start transmitting.

[MENU] » **RECORD** > Recorder Set > **PTT Auto REC**

TIP: About the icons

- While recording, “●” is displayed under the clock readout and the SD card indicator next to the SD card slot blinks blue.
- While pausing, “||” is displayed.

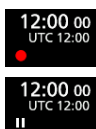

NOTE:

- To record a QSO, an SD card (user supplied) is required.
- **DO NOT** remove the SD card from the transceiver while recording. Otherwise, the recording stops, and the card data may be corrupted or deleted.
- Once the recording starts, it pauses and resumes if the transceiver is turned OFF and ON again.
- The recording continues until you touch <<REC Stop>>, or the free space on the SD card has run out.
- When the recording file's size becomes 2 GB, the transceiver continues to record, but to a new file.

◇ Using the [REC] screen

- Hold down **[REC]** for 1 second.
 - Starts recording.
 - “Recording started.” is briefly displayed.
- ① To stop recording, hold down **[REC]** for 1 second again.

◇ Using the QUICK MENU screen

1. Push **[QUICK]**.
 - Opens the QUICK MENU screen.
2. Touch “<<REC Start>>.”



- Starts recording.
- “Recording started.” is briefly displayed.
- ① To stop recording, open the QUICK MENU screen again and touch “<<REC Stop>>.”

◇ Using the MENU screen

1. Open the QSO RECORDER screen.
 - [MENU]** » **RECORD**
2. Touch “<<REC Start>>.”

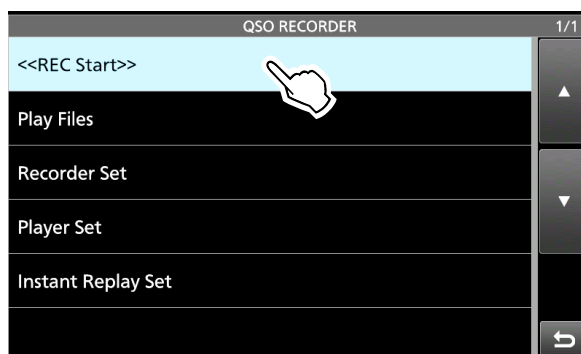

- Starts recording.
- “Recording started.” is briefly displayed.
- ① To stop recording, touch “<<REC Stop>>.”
- 3. To close the QSO RECORDER screen, push **[EXIT]**.

Playing back a QSO audio

You can playback the recorded QSO audio.

1. Insert the SD card in which the recorded audio is saved.
2. Open the PLAY FILES screen.
MENU » **RECORD > Play Files**

3. Touch the folder where the file you want to playback is saved.

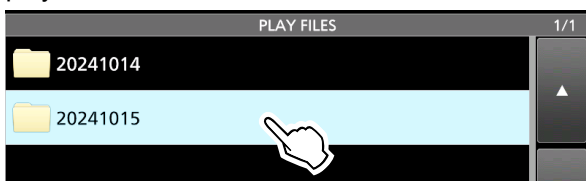

① The folder is named in the following format:
 YYYYMMDD (YYYY: Year, MM: month, DD: day).

4. Touch the desired file.

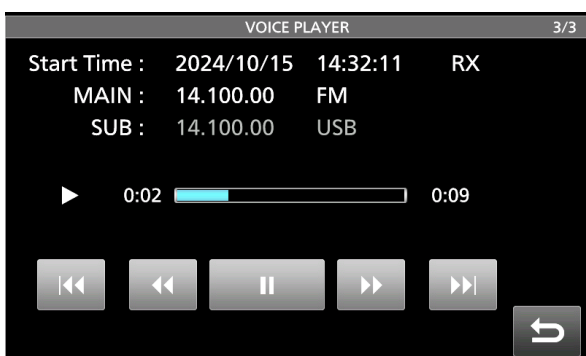
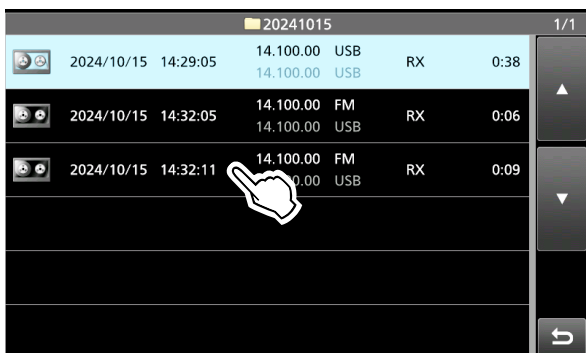

- Starts a playback.
- ① The file is named in the following format:
 YYYY/MM/DD hh:mm:ss (YYYY: Year, MM: month, DD: day, hh: hour, mm: minute, ss: second).
- ① Playback continues to the next file and stops when the last file in the folder is played back.

5. To close the PLAY FILES screen, push **EXIT** several times.

| Key | Action |
|-----|---|
| | Plays the previous file. ① While the oldest file is playing back, pushing starts playing the beginning of the oldest file, even if there are other files in the folder. |
| | Plays the next file. ① While the most recent file is playing back, pushing stops the playback, even if there are other files in the folder. |
| | Rewinds to the skip time point. (Default: 10 seconds) ① If you touch within the first 1 second of the file, the end of the previously recorded file will play back. |
| | Fast forwards to the skip time point. (Default: 10 seconds) |
| | Pauses while playing ① is displayed while pausing. |
| | Plays the file. ① is displayed while playing. |

① You can change the skip time in the following item.

MENU » **RECORD > Player Set > Skip Time**

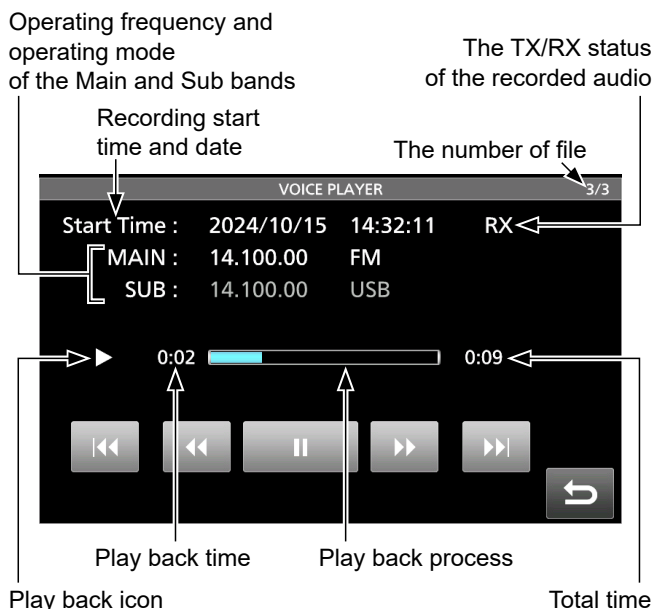

Checking the folder or file information

You can check the folder name, size, and saved date or recorded file's operating frequency, operating mode, date, and so on.

Checking the folder information

1. Open the PLAY FILES screen.
MENU » RECORD > Play Files

2. Touch a folder for 1 second.



- Opens the QUICK MENU screen.

3. Touch "Folder Information."

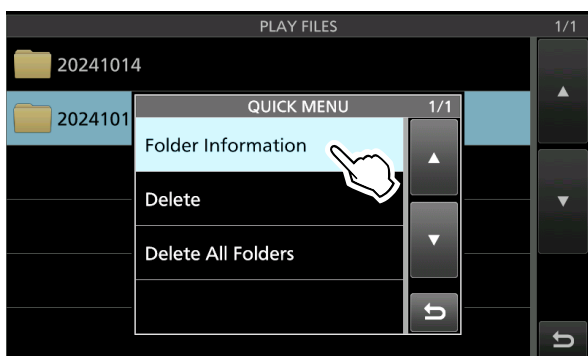

- The FOLDER INFORMATION screen is displayed.

4. To close the PLAY FILES screen, push EXIT several times.

Checking the file information

1. Open the PLAY FILES screen.
MENU » RECORD > Play Files

2. Touch a folder.



3. Touch a file to check its information for 1 second.



- Opens the QUICK MENU screen.

4. Touch "File Information."

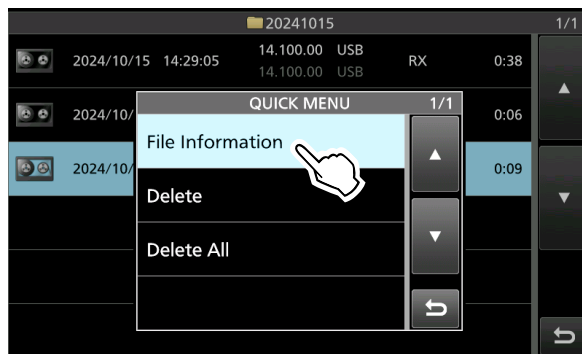

- The FILE INFORMATION screen is displayed.

5. To close the PLAY FILES screen, push EXIT several times.

5 VOICE RECORDER FUNCTIONS

Deleting files

1. Open the PLAY FILES screen.
MENU » **RECORD > Play Files**

2. Touch the folder where the file you want to delete is saved.



3. Touch the file that you want to delete for 1 second.

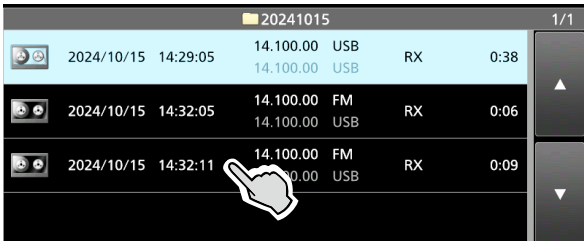

- Opens the QUICK MENU screen.

4. Touch "Delete."

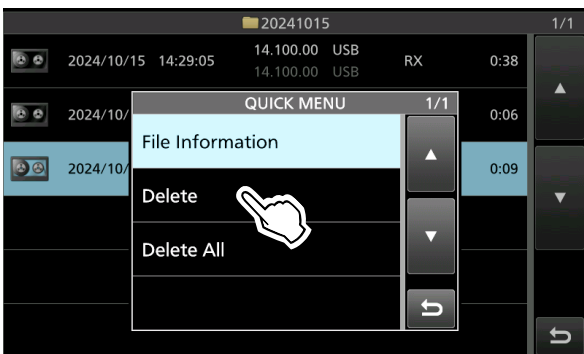

- ① If you want to delete all files in the selected folder, touch "Delete All."

5. Touch [YES].

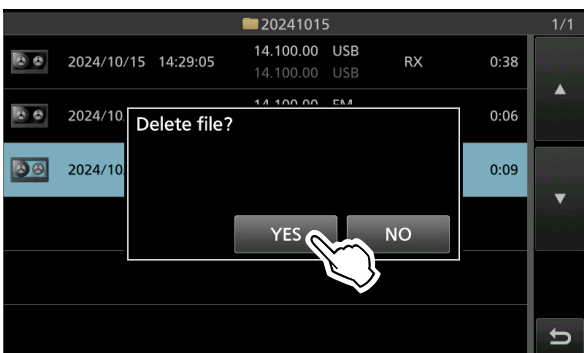

- The file is deleted and returns to the previous screen.

6. To close the PLAY FILES screen, push **EXIT** several times.

Deleting folders

NOTE: All the files in the folder are also deleted.

1. Open the PLAY FILES screen.
MENU » **RECORD > Play Files**
2. Touch the folder you want to delete for 1 second.

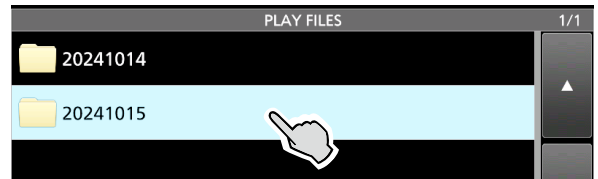

- Opens the QUICK MENU screen.
3. Touch "Delete."

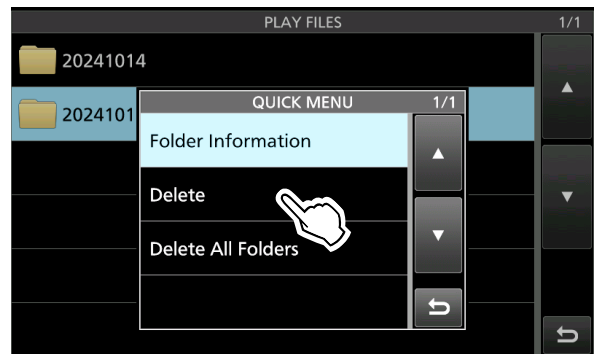

- ① If you want to delete all folders, touch "Delete All Folders."

4. Touch [YES].

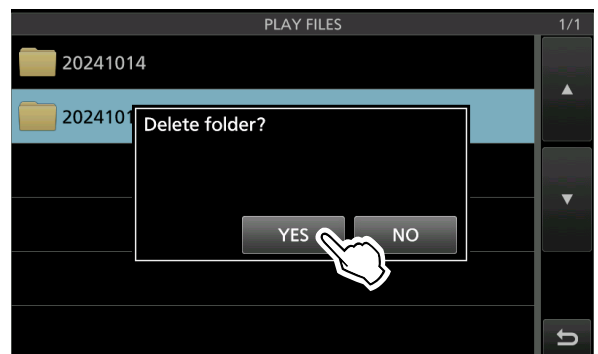

- The folder is deleted and returns to the previous screen.

5. To close the PLAY FILES screen, push **EXIT** several times.

RECORDER SET screen

You can change the recorder settings on this screen.

1. Display the RECORDER SET screen.

MENU » **RECORD** > **Recorder Set**

2. Touch the item to set. (Example: TX REC Audio)

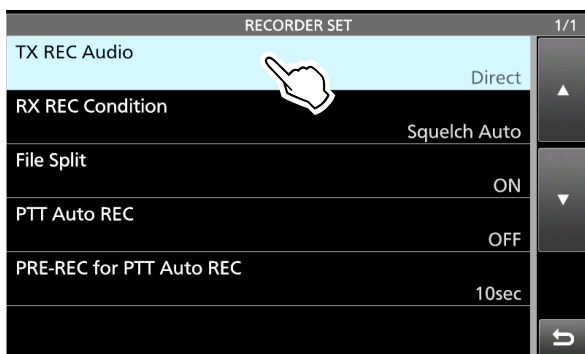

3. Touch the option to set. (Example: Monitor)



4. To close the RECORDER SET screen, push

EXIT.

TIP: You can set each item to its default by touching the item for 1 second, and then touching "Default" on the QUICK MENU screen.

TX REC Audio (Default: Direct)

Selects the transmit audio to record.

- Direct: Records the microphone audio.
- Monitor: Records the TX monitor audio.

RX REC Condition (Default: Squelch Auto)

Selects the recording setting for receive.

- Always: Records even if no signal is received.
- Squelch Auto: Records only when the squelch opens.
(The recording will be paused when the squelch closes while recording.)

File Split (Default: ON)

Turns the File Split function ON or OFF.

- OFF: The audio is continuously recorded into the file, even if you switch between transmit and receive, or the squelch status changes between open and closed.
When the recording file's size becomes 2 GB, the transceiver continues to record, but to a new file.
- ON: While recording, if you switch between transmit and receive, or the squelch status changes between open and closed, a new file is automatically created in the same folder, and the audio is saved into the new one.

PTT Auto REC (Default: ON)

Turns the PTT Automatic Recording function ON or OFF.

- OFF: The recording does not start, even when a signal is transmitted.
- ON: The recording automatically starts when a signal is transmitted.

The recording will stop when:

- 10 seconds have passed after the last transmission.
- 10 seconds have passed if no signal is received after the last transmission.
 - If you receive a signal within 10 seconds after the last transmission, the received audio is also recorded.
 - If you receive another signal within 10 seconds after the last reception, the received audio is also recorded.
- 10 minutes have passed while operating with the squelch is open in the SSB, CW, RTTY, or AM mode.
- The frequency or operating mode is changed.

PRE-REC for PTT Auto REC (Default: 10sec)

Selects whether or not to record the audio that is received before the PTT Automatic Recording function is activated.

- OFF: Does not record the audio.
- 5sec/10sec/15sec:
Records the audio that is previously received in this set period of time.

5 VOICE RECORDER FUNCTIONS

PLAYER SET screen

You can fast forward or rewind while playing back. You can change the skip time in the PLAYER SET screen.

1. Display the PLAYER SET screen.

MENU » **RECORD > Player Set**

2. Touch “Skip Time.”

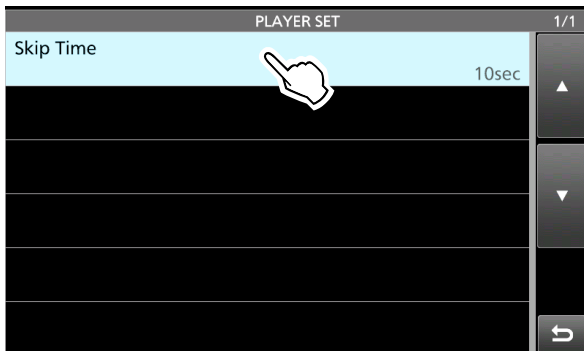

3. Touch the option to set. (Example: 5sec)

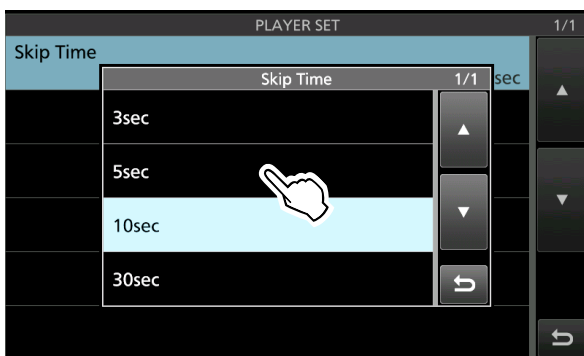

4. To close the PLAYER SET screen, push **EXIT**.

TIP: You can set the item to its default by touching the item for 1 second, and then touching “Default” on the QUICK MENU screen.

Playing back audio on a PC

You can also playback the voice memory data on a PC.

① The recorded information (frequency, date, and so on) is not displayed.

1. Insert the SD card into the memory card slot or memory card reader (user supplied) on your PC.

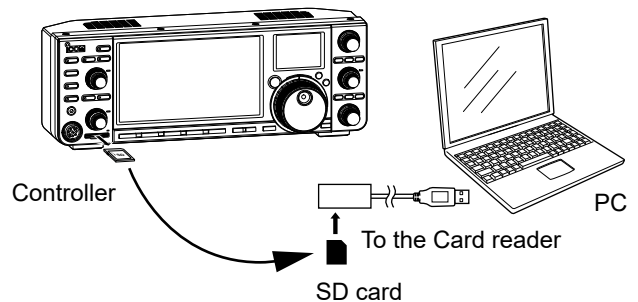

2. Open the “Voice” folder.
① See page 4-6 for detail.
3. Open the folder where the file you want to playback is saved.
① The folders are titled based on the recorded date. (YYYYMMDD)
4. Open the file that you want to play back.
 - The audio starts playing back.
 - ① The files are titled based on the date and time (YYYYMMDD_hhmmss.wav).

NOTE:

- The operations while playing back may differ, depending on the application. Refer to the application’s instruction manual for details.
- When the file does not playback, even if you double click the file, download an appropriate software application.

Instant Replay function

◇ Recording the Instant Replay

The Instant Replay function records the previous 15 seconds (default) from the time when **REC** has been pushed. The audio is recorded into the built-in memory.

① You can only record once, and the memory is overwritten by pushing **REC** again.

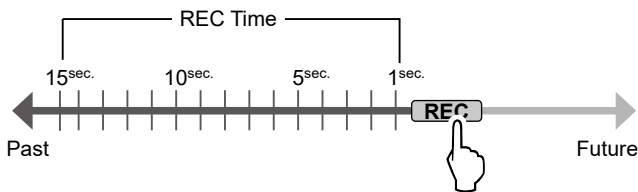

◇ Playing back the Instant Replay

After recording an audio using the Instant Replay function, you can play back the last 5 seconds (default) from the time **PLAY** was pushed.

① While playing back, **▶PLAY** is displayed.

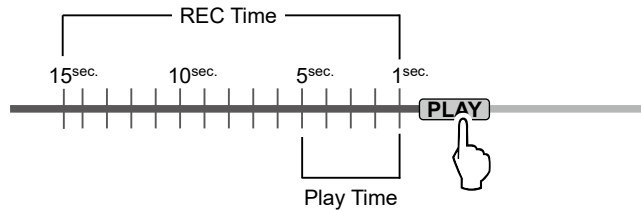

Playing back all the recorded memory

After recording an audio using the Instant Replay function, you can also play back the entire memory from the top, by holding down **PLAY** for 1 second.

① While playing back, **▶PLAY** is displayed.

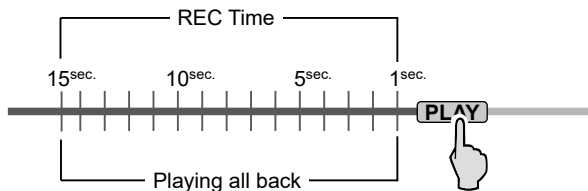

INSTANT REPLAY SET screen

You can set the recording time and the playing back time for the Instant Replay function.

① See the left column for using the Instant Replay function.

1. Display the INSTANT REPLAY SET screen.
MENU » **RECORD > Instant Replay Set**
2. Touch the item to set. (Example: REC Time)

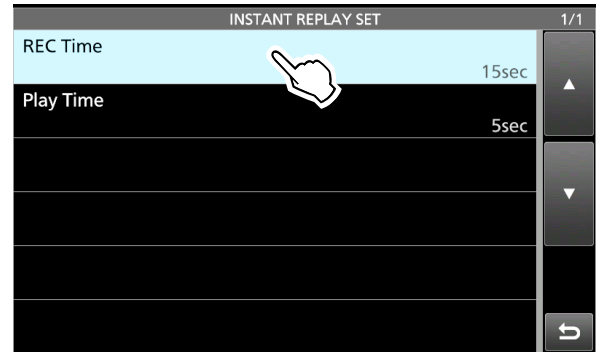

3. Rotate **⊕MULTI** to set the recording time.

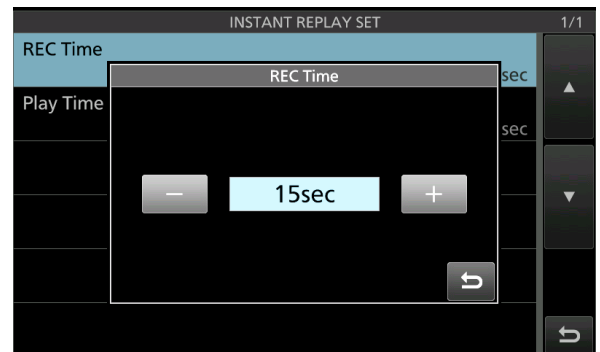

4. To close the INSTANT REPLAY SET screen, push **EXIT**.

TIP: You can set the item to its default by touching the item for 1 second, and then touching "Default" on the QUICK MENU screen.

REC Time (Default: 15sec)

Sets the recording time for the Instant Replay function to between 5 ~ 30 seconds. The audio is saved in the built-in audio memory.

Play Time (Default: 5sec)

Sets the play back time for the Instant Replay function to between 3 ~ 10 seconds.

The Instant Replay function plays back the recorded audio in the built-in audio memory, from the last 5 seconds (default) from the time **REC** was pushed.

Section 6

VOICE TX MEMORY FUNCTION

| | |
|---|-----|
| Recording a Voice TX memory..... | 6-2 |
| ◇ Recording | 6-2 |
| ◇ Playing back | 6-2 |
| Entering a Voice TX memory name..... | 6-3 |
| Transmitting a Voice TX memory content..... | 6-4 |
| ◇ Transmitting..... | 6-4 |
| ◇ Repeatedly transmitting..... | 6-4 |
| ◇ Adjusting the output level | 6-5 |
| VOICE TX SET screen | 6-5 |

Recording a Voice TX memory

SSB, AM, and FM modes

You can record up to 8 Voice transmit (TX) memories (T1 ~ T8) onto an SD card. To transmit a recorded content using a Voice TX memory, first record the message, as described below.

- ① You can record up to 1 and a half minutes in each memory.
- ① You can also transmit the recorded content using an external keypad.

NOTE: To use the Voice TX memory function, an SD card (user supplied) is required.

Recording

1. Display the VOICE TX screen.

MENU » **VOICE**

2. Touch [REC/SET].

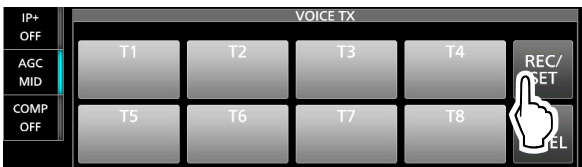

3. Touch "REC."

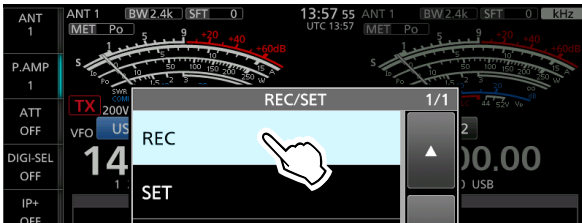

• Opens the VOICE TX RECORD screen.

4. Touch [T1 ~ T8] of the desired Voice memory "T1" ~ "T8." (Example: T1)

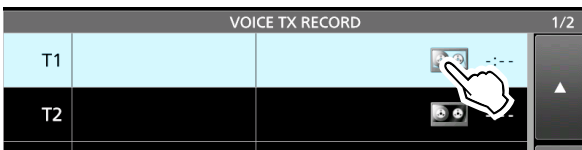

5. Touch [Red Dot] to start recording.

Adjust the Mic gain so that the "REC Level" meter reads less than 80%.

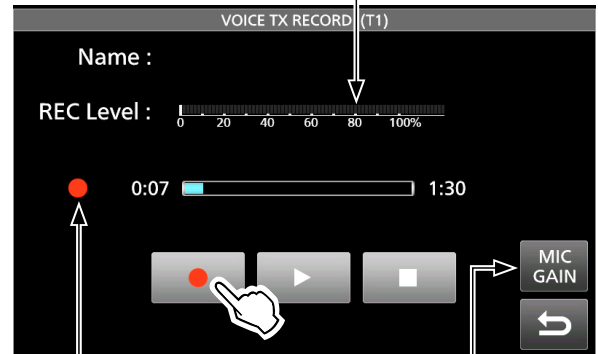

Displayed while recording

Touch to open the MIC GAIN adjustment window.

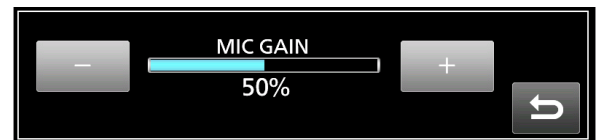

- Without holding down [PTT], speak into the microphone at your normal voice level.
 - ① Previously recorded content is overwritten.
6. Touch [Stop] to stop recording.
 7. To close the VOICE TX RECORD screen, push **EXIT** several times.

TIP: How to clear the recorded content
Touch the Voice TX memory for 1 second in step 4, and then touch "Clear" in the QUICK MENU screen.

Playing back

1. On the selected memory's recording screen, touch [Play] to start playing back without transmitting.



Displayed while playing

- ① To stop the playback, touch [Stop].
2. To close the VOICE TX RECORD screen, push **EXIT** several times.

6 VOICE TX MEMORY FUNCTION

Entering a Voice TX memory name

You can assign a name to recorded Voice TX memories.

Example: Entering “Contest” in Memory T1

1. Open the VOICE TX RECORD screen.
MENU » **VOICE > REC/SET > REC**
2. Touch the desired memory for 1 second.
① The selected memory needs to contain a recording.

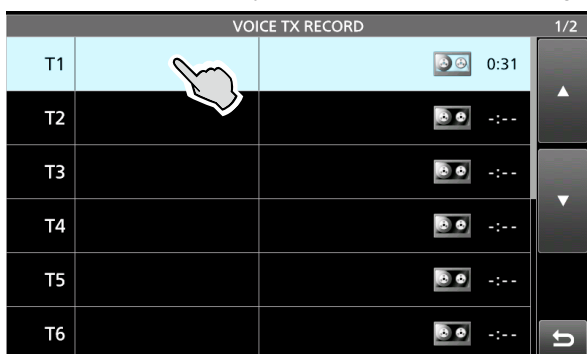

3. Touch “Edit Name.”

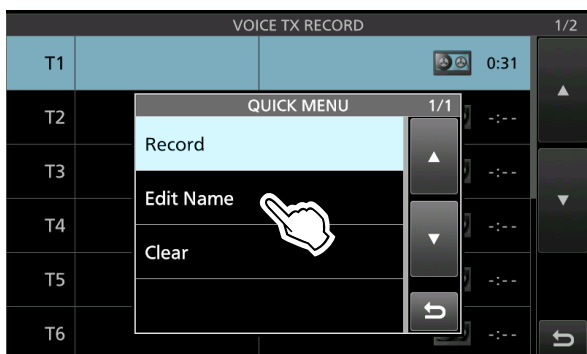

- Opens the Name editing screen.
- ① When a USB keyboard is connected, you can edit directly using the keyboard without opening the Name editing screen.

4. Enter a name of up to 16 characters, and then touch [ENT] to save.
① See page iii on how to enter characters.

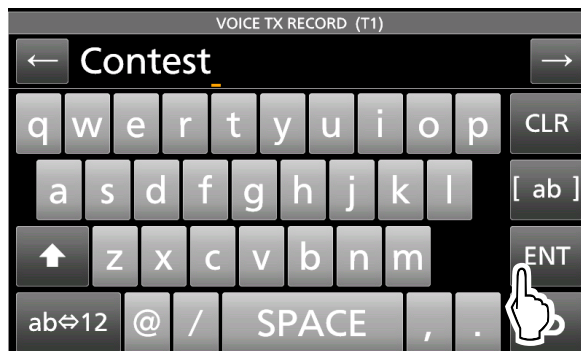

5. To close the VOICE TX RECORD screen, push **EXIT**.

Transmitting a Voice TX memory content

You can transmit the Voice TX memory contents once, or repeatedly. This is useful for transmitting your call sign or name in some contests, or repeatedly calling CQ.

◇ Transmitting

Transmits the prerecorded content. (p. 6-2)

1. Display the VOICE TX screen.

MENU » **VOICE**

2. Touch the desired Voice memory key [T1] ~ [T8].

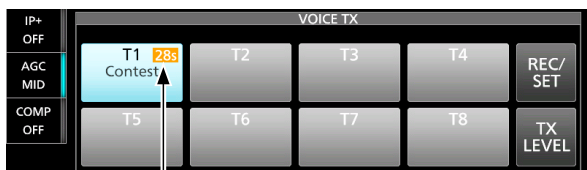
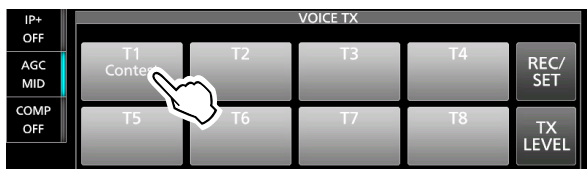

The transmission's remaining time

- Transmits the recorded content once.

3. To close the VOICE TX screen, push **EXIT**.

When a USB keyboard is connected:
 You can transmit the preset contents in the Voice TX memory (T1 ~ T8) from a keyboard by setting "Keyboard [F1]-[F8] (VOICE)."
 ① To repeatedly transmit the recorded contents, push [F1] ~ [F8] while holding down [Shift].
MENU » **SET > Connectors > Keyboard/Mouse**

When an external keypad is connected:
 You can transmit the preset contents in the Voice TX memory (T1 ~ T8) from an external device by setting the "External Keypad," and then connecting an external keypad to [EXT-KEYPAD] or [MIC] on the controller.
MENU » **SET > Connectors > External Keypad**

◇ Repeatedly transmitting

1. Display the VOICE TX screen.

MENU » **VOICE**

2. Touch the desired Voice memory key [T1] ~ [T8] for 1 second.

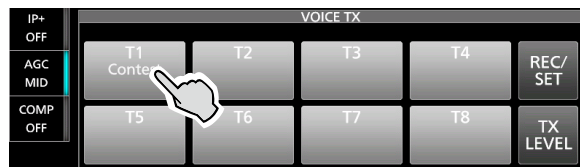

Repeat icon The transmission's remaining time

- Repeatedly transmits the recorded content.

① Information

- The recorded content is repeatedly transmitted for 10 minutes unless you manually stop transmission by touching the selected memory.
- The Memory Timer counts down.
- is displayed while repeatedly transmitting.
- You can set the pause interval between the repeated transmissions in "Repeat Time" on the VOICE TX SET screen. During this interval, the transceiver returns to receive. (p. 6-5).
- After 10 minutes have passed, and all of the recorded content in the memory is transmitted, the transceiver automatically returns to receive.
- When a signal is received in the interval between transmissions, the transceiver pauses the next transmission until the signal disappears. However, if the squelch is set to open, the transceiver repeatedly transmits after the repeat interval time expires, even when signals are received.

3. To close the VOICE TX screen, push **EXIT**.

TIP:

- If the "DATA OFF MOD" is set to "USB," "LINE-IN," "ACC," or "LAN," Voice TX memories can not be transmitted.
MENU » **SET > Connectors > MOD Input > DATA OFF MOD**
- To cancel transmitting the recorded audio by pushing [PTT] on the microphone, set "PTT Port Function" to "PTT Input."
MENU » **SET > Connectors > PTT Port Function**

6 VOICE TX MEMORY FUNCTION

Transmitting a Voice TX memory content

◇ Adjusting the output level

Adjust the Voice TX memory level.

1. Display the VOICE TX screen.

MENU » **VOICE**

2. Touch [TX LEVEL].

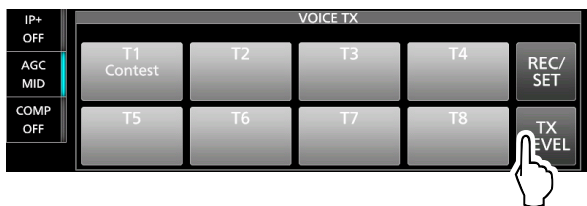

3. Touch any Voice memory key other than [T4] or [T8]. ([T1] ~ [T3], [T5] ~ [T7])



- The transceiver automatically transmits.

① To adjust the Transmit voice level using [T4] or [T8], reverse steps 2 and 3.

4. While transmitting, rotate **(MAIN DIAL)** to adjust the transmit voice level.

① Pushing [DEF] for 1 second returns the value to the default.

① Adjusting TX LEVEL too high may result in over modulation and transmit signal distortion.

5. To save and close the VOICE TX screen, push

EXIT several times.

VOICE TX SET screen

You can set the Automatic Monitor function and the Transmit Repeat Interval on this screen.

1. Display the VOICE TX SET screen.

MENU » **VOICE > REC/SET > SET**

2. Touch the item to set. (Example: Auto Monitor)

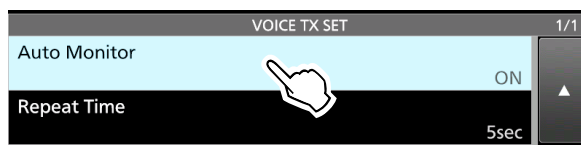

3. Touch the option to set. (Example: OFF)

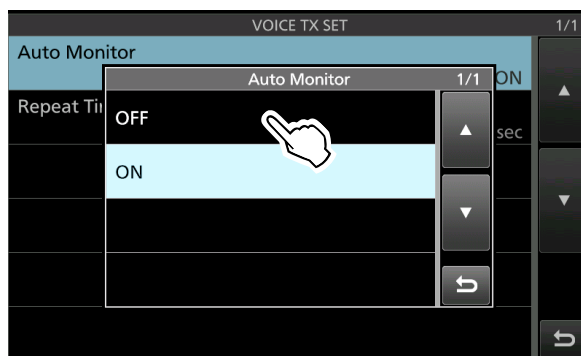

4. To close the VOICE TX SET screen, push **EXIT**.

TIP: You can set each item to its default by touching the item for 1 second, and then touching "Default" on the QUICK MENU screen.

Auto Monitor (Default: ON)

Turns the Automatic Monitor function for recorded audio content transmission, ON or OFF.

- ON: Automatically monitors transmit audio when sending recorded audio.
- OFF: Monitors transmit audio only when the Monitor function is ON.

Repeat Time (Default: 5sec)

Sets the repeat interval to repeat the voice transmission. The transceiver repeatedly transmits the recorded content at this interval.

- Set to between 1 and 15 seconds.

① Repeatedly transmits the recorded content for up to 10 minutes.

① After 10 minutes have passed, and all of the recorded content in the memory is transmitted, the transceiver automatically returns to receive.

| | |
|---|-----|
| Memory channels | 7-2 |
| Entering Memory channel contents | 7-2 |
| Selecting a Memory channel | 7-3 |
| ◇ Selecting with (MULTI) | 7-3 |
| ◇ Selecting on the MEMORY screen | 7-3 |
| Copying the Memory channel contents | 7-4 |
| ◇ Copying to the VFO | 7-4 |
| ◇ Copying to another Memory channel | 7-4 |
| Entering a Memory channel name | 7-5 |
| Clearing a Memory channel | 7-6 |
| MEMORY screen | 7-6 |
| Memo Pad | 7-7 |
| ◇ Saving the contents into a Memo Pad | 7-7 |
| ◇ Calling up the Memo Pads | 7-7 |
| ◇ MEMO PAD screen | 7-7 |

Memory channels

The Memory mode enables you to quickly select often-used frequencies, modes, and other parameters. While operating in the Memory mode, you can temporarily change the operating frequency, mode, and so on, without overwriting the Memory channel contents.

- ① To save the changed value, overwrite the Memory channel contents, or copy to another Memory channel. (p. 7-4)

| Memory channel | Displayed |
|----------------|--|
| 1 to 99 | Regular Memory channels. One frequency, one mode, one filter, memory channel name, tone settings (including tone frequencies for repeater and tone squelch), and select memory scan setting in each memory channel. |
| P1/P2 | Scan Edge memory channels. One frequency, and one mode and one filter in each memory channel as scan edges for programmed scans. ① They cannot be left blank. |

Entering Memory channel contents

NOTE: The new content you enter will overwrite any content already in the selected memory.

1. Select the Main band or Sub band.
(Example: Main band)
2. Touch the VFO/MEMORY icon to open the VFO/MEMORY screen.
① You can also select the mode by touching "VFO/MEMORY" on the QUICK MENU screen.
3. Touch [VFO] to select the VFO mode.
4. Set the frequency, operating mode, and other parameters.
5. Touch [MEMORY] to select the Memory mode, and then rotate **ⓂMULTI** to enter the contents set in step 4.

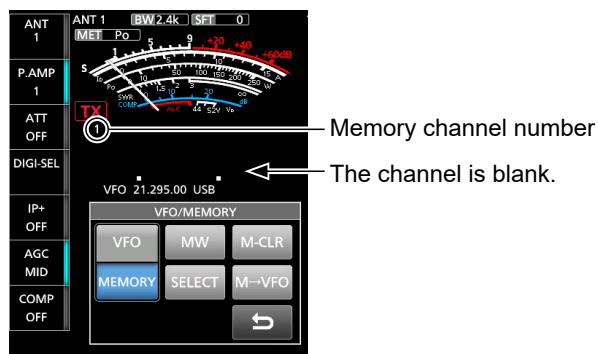

6. Select the VFO mode again.
7. Touch [MW] for 1 second.
 - The contents are entered in the selected Memory channel.

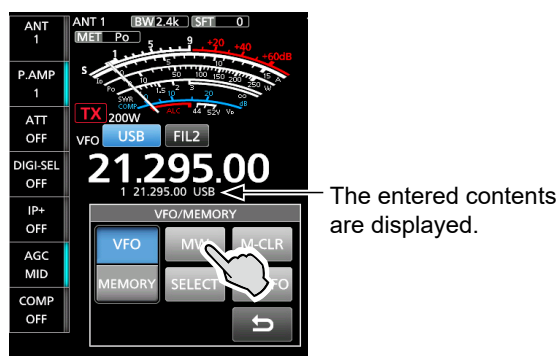

- ① To enter another channel with the same operating mode and settings, but on a different frequency, repeat steps 4 ~ 7 after changing the frequency.

8. To close the VFO/MEMORY screen, push **EXIT**.

To edit the Memory channel contents:

1. Select the Memory channel to edit.
2. Change the frequency and other parameters in the Memory mode.
3. Open the VFO/MEMORY screen.
4. Touch [MW] for 1 second to overwrite onto the selected Memory channel.

Selecting a Memory channel

There are 3 ways to select a Memory channel.

- Select with **MULTI**
- Select on the MEMORY screen
- Select using the keypad (Basic manual)

◇ Selecting with **MULTI**

1. Select the Memory mode.
2. Confirm the function indicator for **MULTI** displays "M-CH."
3. Rotate **MULTI** until you select the Memory channel you want to use.



Memory mode
(Example: channel 1)

◇ Selecting on the MEMORY screen

1. Select the Memory mode.
2. Open the MEMORY screen.

MENU » **MEMORY**

3. Touch the Memory channel that you want to use.

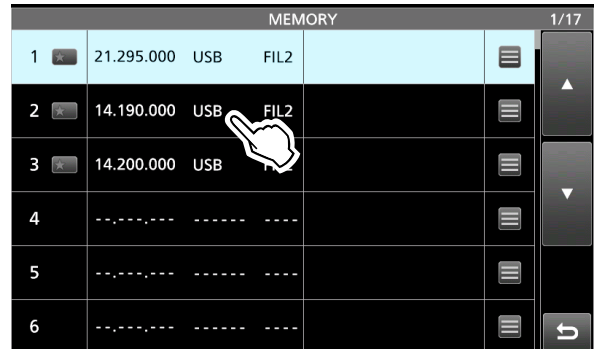

- The channel is selected and automatically closes the MEMORY screen.

Copying the Memory channel contents

You can copy a Memory channel contents to the VFO or to another Memory channel.

◇ Copying to the VFO

1. Select the Main band or Sub band.
2. Select the Memory mode.
3. Confirm the function indicator for **[MULTI]** displays "M-CH."
4. Rotate **[MULTI]** to select the channel to be copied. (Example: channel 2)

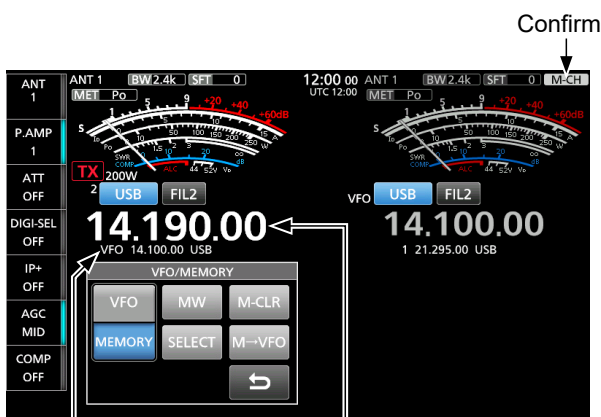

The selected channel to be copied

VFO mode contents before copying: 14.100.00 USB

5. Touch **[M→VFO]** for 1 second.
 - The selected Memory channel contents are copied to the VFO.

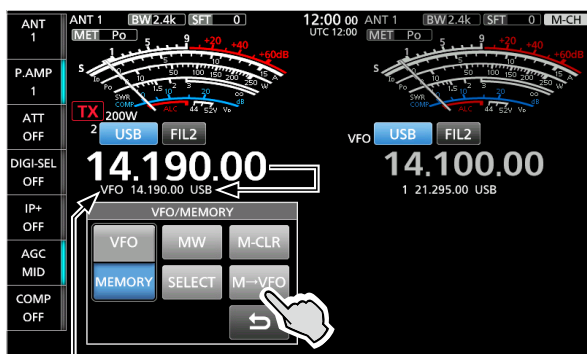

VFO mode contents after copying: 14.190.00 USB

6. Touch **[VFO]** to select the VFO mode.
7. To close the VFO/MEMORY screen, push **[EXIT]**.

◇ Copying to another Memory channel

1. Select the Main band or Sub band.
2. Select the Memory mode.
3. Confirm the function indicator for **[MULTI]** displays "M-CH."
4. Rotate **[MULTI]** to select the channel to be copied. (Example: channel 3)



The selected channel to be copied

5. Open the MEMORY screen. **[MENU] » [MEMORY]**
6. Touch **[M]** of the channel that you want to write the copied contents to. (Example: channel 5)
 - ① **DO NOT** rotate **[MULTI]**. Select the channel by rotating **[MAIN DIAL]**.

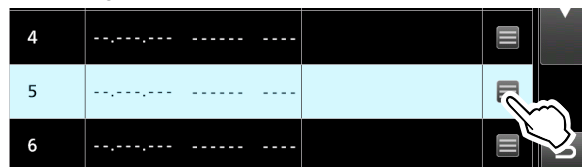

7. Touch "Memory Write."

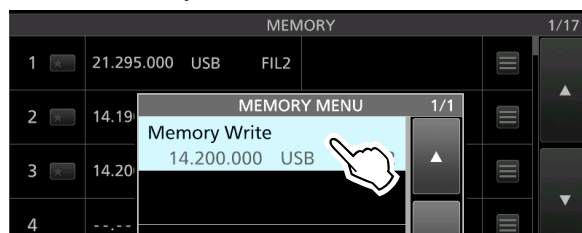

8. Touch **[YES]**.

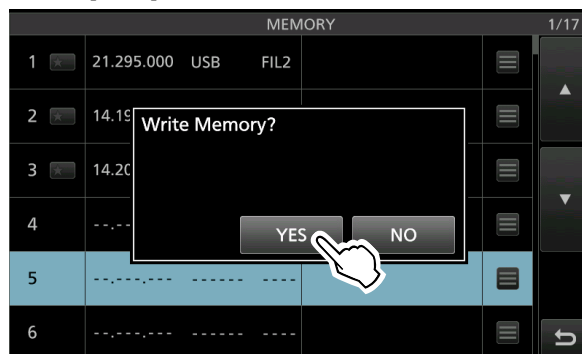

- The selected Memory channel contents are copied.
9. To close the MEMORY screen, push **[EXIT]**.

Entering a Memory channel name

You can assign a name of up to 16 characters to each Memory channel.

1. Open the MEMORY screen.

MENU » **MEMORY**

2. Touch  of the channel that you want to assign a name to. (Example: channel 2)

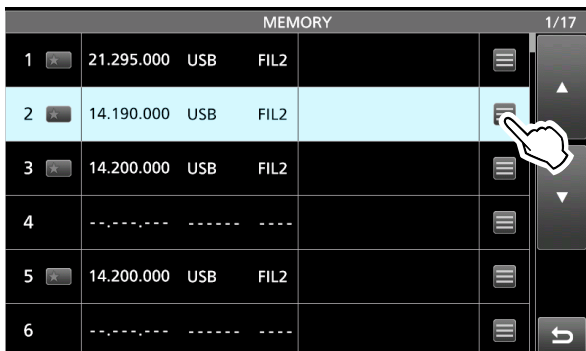

3. Touch “Edit Name.”

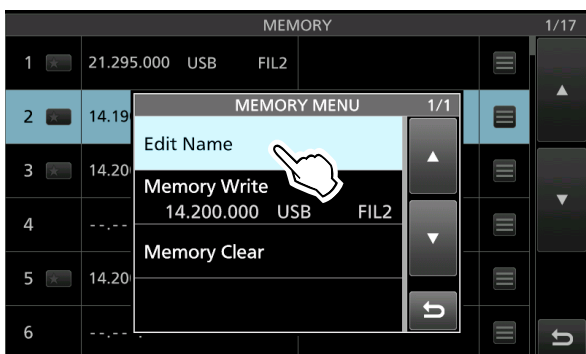

- Opens the Memory Name editing screen.
- ① When a USB keyboard is connected, you can edit directly using the keyboard without opening the Memory Name editing screen.

4. Enter a name, then touch [ENT].

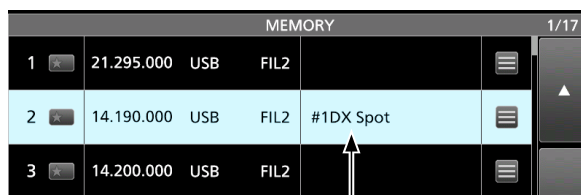

Memory channel name

5. To close the MEMORY screen, push **EXIT**.

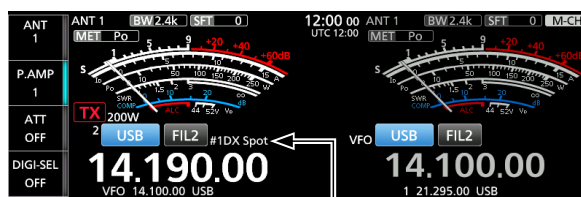

Memory channel name

- ① The Memory channel name is not displayed when the Mini Scope screen or expanded screen is displayed.
- ① You can also select not to display the Memory name on the standby screen.

MENU » **SET > Display > Memory Name**

Clearing a Memory channel

You can clear a no-longer-used Memory channel and reset it as a blank channel, except for the program channels (P1 and P2).

1. Select the Main band or Sub band.
2. Select the Memory mode.
3. Confirm the function indicator for **[MULTI]** displays "M-CH."
4. Rotate **[MULTI]** to select the channel to be cleared. (Example: channel 3)

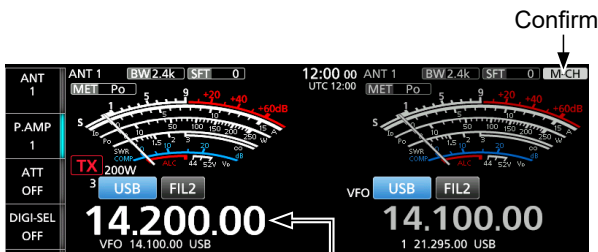

The memory channel to clear

5. Touch **[M-CLR]** for 1 second.

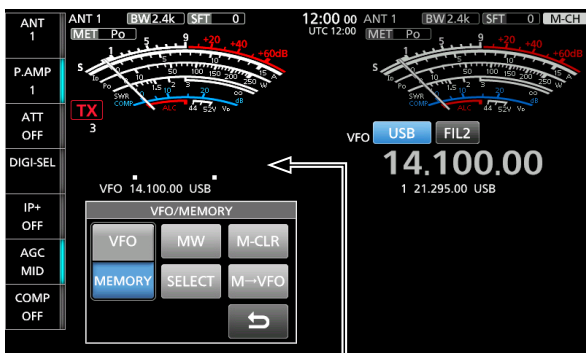
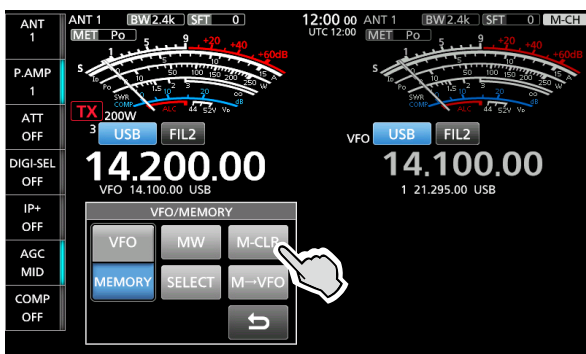

Cleared

6. To close the VFO/MEMORY screen, push **[EXIT]**.

MEMORY screen

[MENU] » **[MEMORY]**

You can edit Memory channel contents on the MEMORY screen.

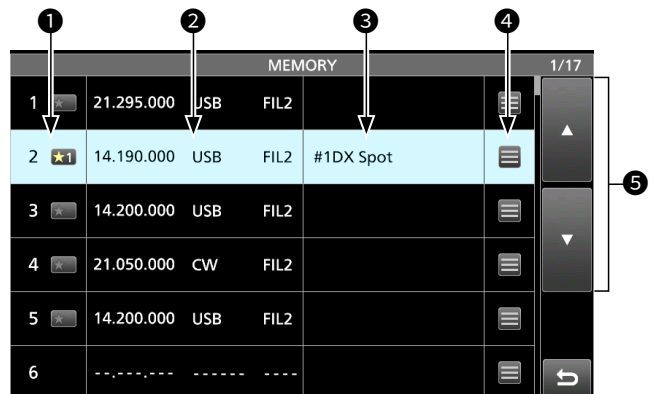

1 Memory channel number

Displays the Memory channel number (1 ~ 99, P1, P2).

① P1 and P2 cannot be left blank.

Memory select icon

- Touch this icon to set the Select number "★1," "★2," "★3," or OFF.

① See page 8-5 for the Select Memory scan.

- Touch the icon for 1 second to display the SELECT ALL CLEAR screen, and then select the desired item to reset the Select number.

2 Frequency/Operating mode/IF filter

Displays the entered frequency, selected operating mode, and the IF filter.

3 Memory channel name

Displays the memory channel name, if entered.

① See page 7-5 for details.

4 Memory menu

Touch to display the MEMORY MENU screen.

① You can select "Edit Name," "Memory Write," or "Memory Clear."

5 [▲] and [▼]

Touch to scroll through the Memory channels, 6 channels at a time.

TIP: About the QUICK MENU screen

While selecting a Memory channel with memory contents, push **[QUICK]** to open the QUICK MENU screen. You can select SELECT, Edit Name, Memory Write, Memory Clear, or SELECT All Clear.

Memo Pad

There are 5 Memo Pads as the default to save frequencies and operating modes for easy writing and recall. You can increase the Memo Pads to 10 in the following item.

MENU » **SET > Function > Memo Pad Quantity**

① The Memo Pads are separate from Memory channels.

Memo Pads are convenient when you want to temporarily memorize a frequency and operating mode, such as when you find a DX station in a pile-up, or when the desired station is busy for a long time and you want to temporarily look for other stations.

◇ Saving the contents into a Memo Pad

1. Select the Main band or Sub band.
2. Select the VFO mode.
3. Set the frequency and operating mode, then push **MPAD** for 1 second.

① When you save up to the set number of Memo Pads in "Memo Pad Quantity," the oldest Memo Pad is automatically cleared for the new Memo Pad.

NOTE: Each Memo Pad must have its own unique contents. The Memo Pads with identical content cannot be saved.

◇ Calling up the Memo Pads

1. Select the VFO mode.
2. Push **MPAD** several times until the desired Pad is displayed.
 - ① Pushing **MPAD** selects the Memo Pads.
 - ① The most recently saved Memo Pad is selected first.

◇ MEMO PAD screen

The MEMO PAD screen displays the saved contents in a list, in which you can select or delete the saved contents.

MENU » **MPAD**



Temporary Pad

TIP: If you change the frequency or operating mode called up from Memo Pads, the contents are automatically updated in a temporary Pad.

| Key | Action | |
|---------|---|--------------------------------|
| ▲/▼ | Scrolls through the list. | |
| DEL | Touch for 1 second | Deletes the selected Memo Pad. |
| DEL ALL | Touch for 1 second | Deletes all the Memo Pads. |
| EXPAND | Select to display the MEMO PAD list in the Expanded or Normal screen. | |

| | |
|---|-----|
| Scan types..... | 8-2 |
| Preparation..... | 8-2 |
| ◇ Squelch status..... | 8-2 |
| SCAN screen..... | 8-3 |
| SCAN SET screen..... | 8-3 |
| Programmed scan and Fine Programmed scan..... | 8-4 |
| ◇ Programmed scan operation..... | 8-4 |
| Memory scan..... | 8-5 |
| ◇ Memory scan operation..... | 8-5 |
| Select Memory scan..... | 8-5 |
| ◇ Setting the Select Memory channels..... | 8-5 |
| ◇ Select Memory scan operation..... | 8-6 |
| ΔF scan and Fine ΔF scan..... | 8-7 |
| ◇ ΔF scan operation..... | 8-7 |

Scan types

VFO SCAN

Used to detect signals by automatically changing the frequency of the VFO mode.

Programmed scan (p. 8-4)

Repeatedly scans between two Scan Edge frequencies.

The Edge frequencies are programmable, and are preset in P1 and P2 as the default. (p. 7-2)

Fine Programmed scan

If the squelch opens while scanning, the tuning step changes to 10 Hz. This reduces the scan speed, but the transceiver keeps scanning.

MEMORY SCAN

Used to detect signals by automatically scanning the memories in the Memory mode.

Memory scan (p. 8-5)

Repeatedly scans all entered Memory channels.

Select Memory scan (p. 8-5)

Repeatedly scans Select Memory channels.

ΔF SCAN (p. 8-7)

Repeatedly scans within the ΔF span area. The scan starts from the center frequency.

Fine ΔF scan

If the squelch opens while ΔF scanning, the tuning step changes to 10 Hz. This reduces the scan speed, but the transceiver keeps scanning.

Preparation

◇ Squelch status

The scan works with the Main band's squelch status. Be sure to adjust the squelch level according to your operating environment.

① Normally, set **(AF \odot RF/SQL)** to the point where the noise just disappears and the RX indicator goes OFF.

When the scan starts with the squelch open:

- When the tuning step is 1 kHz or less, the scan continues until it is manually stopped— it does not pause, even if signals are detected.
- When the tuning step is 5 kHz or more, the scan pauses on each step when the Scan Resume function is ON. It does not pause when the function is OFF.

When the scan starts with the squelch closed:

The scan stops when a signal is detected, regardless of the tuning step.

① When the Scan Resume function is ON, the scan pauses for 10 seconds after detecting a signal, then resumes 2 seconds after the signal disappears.

SCAN screen

Display the SCAN screen.

MENU » **SCAN**

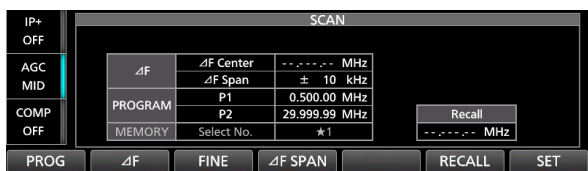

Main band: VFO mode

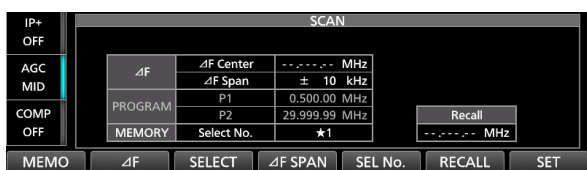

Main band: Memory mode

① To select the VFO or Memory mode, touch [VFO] or [MEMORY] on the VFO/MEMORY screen.

| Key | Action | |
|---------|--|--|
| PROG | Starts or cancels a Programmed scan. | |
| MEMO | Starts or cancels a Memory scan. | |
| ΔF | Starts or cancels a ΔF scan. | |
| FINE | While Programmed scanning, touch to switch to the Fine Programmed scan. While ΔF scanning, touch to switch to the Fine ΔF scan. ① In the Memory mode, this key is displayed when a ΔF scan is started. | |
| ΔF SPAN | Selects a ΔF span. • ±5 kHz, ±10 kHz, ±20 kHz, ±50 kHz, ±100 kHz, ±500 kHz, or ±1 MHz | |
| SELECT | Touch | Selects a Memory channel to set as a Select Memory channel. • “★1,” “★2,” “★3,” or “(no icon)” |
| | Touch for 1 second | Displays the SELECT ALL CLEAR screen. |
| SEL No. | Selects the Select scan number for the Select Memory scan. • “★1,” “★2,” “★3,” or “★1,2,3” | |
| RECALL | Touch for 1 second | Sets the operating frequency to the frequency that was set before starting the scan in the VFO mode. |
| SET | Displays the SCAN SET screen. | |

SCAN SET screen

You can change the recorder settings on this screen.

1. Display the SCAN screen.

MENU » **SCAN**

2. Touch [SET].

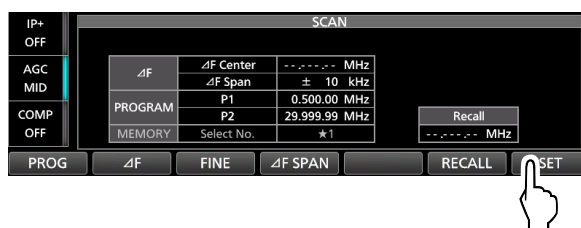

3. Touch the item to set. (Example: SCAN Speed)

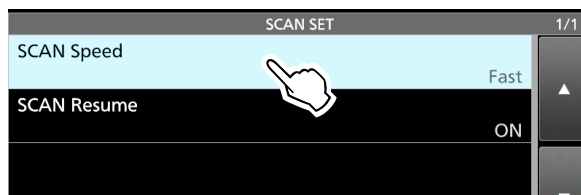

4. Touch the option to set. (Example: Slow)

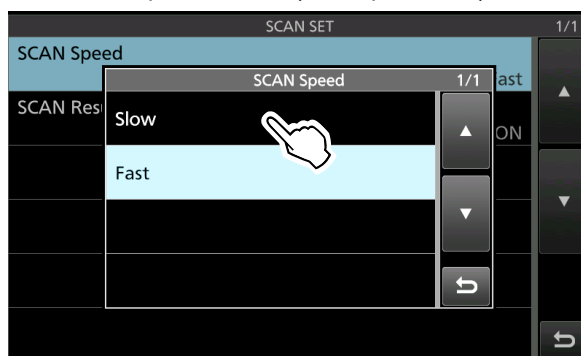

5. To close the SCAN SET screen, push **EXIT**.

TIP: You can set each item to its default by touching the item for 1 second, and then touching “Default” on the QUICK MENU screen.

SCAN Speed (Default: Fast)

Sets the desired scan speed to slow or fast.

- Slow: Scan speed is slow.
- Fast: Scan speed is fast.

SCAN Resume (Default: ON)

Sets the Scan Resume function to ON or OFF.

- OFF: When a signal is detected, cancels the scan.
- ON: When a signal is detected, the scan pauses for 10 seconds, then resumes. Two seconds after the signal disappears, the scan resumes.

Programmed scan and Fine Programmed scan

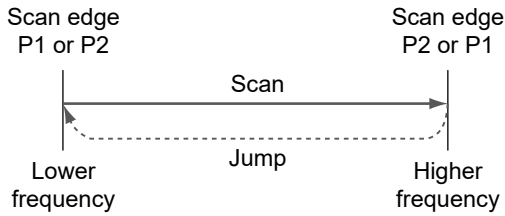

Repeatedly scans between two Scan Edge frequencies.
The edge frequencies are preset in P1 and P2 as the default. (P1: 0.500000 MHz / P2: 29.999999 MHz)

- ① To change the P1 and P2 Scan Edge Memory channels, see page 7-2 for details.
- ① If the same frequencies are entered into P1 and P2, the Programmed scan does not start.
- ① The Fine Programmed scan is most effective in the SSB, CW, and RTTY modes.

◇ Programmed scan operation

1. Select the VFO mode in the Main band.
2. Select the operating mode and tuning step. (Example: USB, 1 kHz)
3. Display the SCAN screen.

MENU » **SCAN**

4. Touch [PROG] to start the Programmed scan.

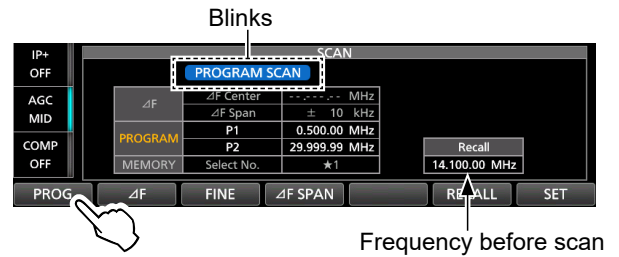

- ① When a signal is detected, the scan pauses according to the “SCAN Resume” setting, and then resumes.
- ① You can change the operating mode and the tuning step while scanning.
- ① To cancel the scan, touch [PROG].

5. To switch to the Fine Programmed scan, touch [FINE].

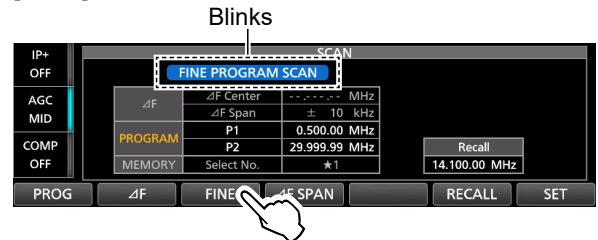

- The tuning step changes to 50 Hz steps.
 - ① When a signal is detected, the tuning step changes to 10 Hz steps.
 - ① To return to the Programmed scan, touch [FINE] again.
6. To close the SCAN screen, push **EXIT**.

Memory scan

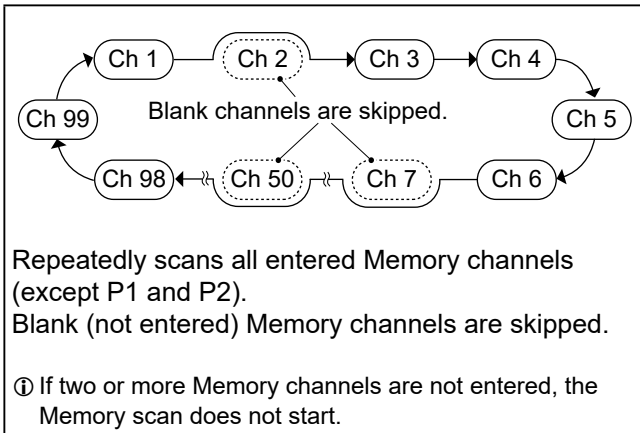

◇ Memory scan operation

1. Select the Memory mode in the Main band.
2. Display the SCAN screen.
MENU » **SCAN**
3. Touch [MEMO] to start the Memory scan.

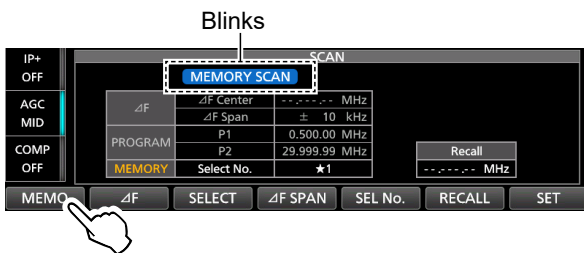

- Blinks
- ① When a signal is detected, the scan pauses according to the "SCAN Resume" setting, and then resumes.
- ① To cancel the scan, touch [MEMO].
4. To close the SCAN screen, push **EXIT**.

Select Memory scan

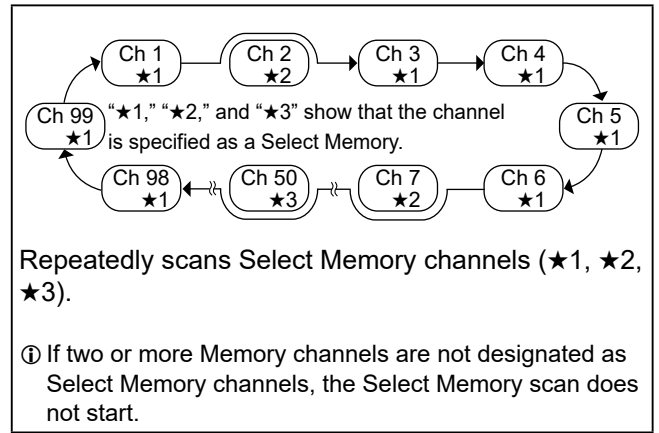

◇ Setting the Select Memory channels

1. Select the Memory mode in the Main band.
2. Display the SCAN screen.
MENU » **SCAN**
3. Rotate **MULTI** to select memory channels to set as Select Memory channels.
4. Touch [SELECT] to set the selected number.
① Each touch selects "★1," "★2," "★3," or "(no icon)."

"★1" is set to Memory channel 1.

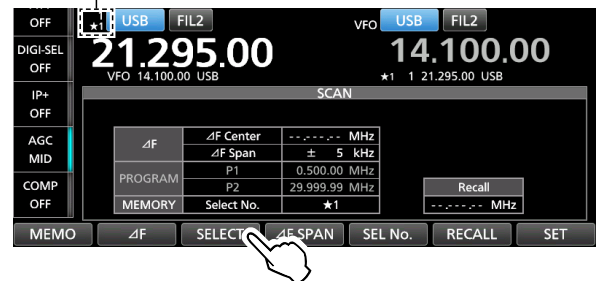

5. Repeat steps 3 and 4 to set more than two Select Memory channels.

TIP: Setting Select Memory channels on the MEMORY screen.

1. Display the MEMORY screen.
MENU » **MEMORY**
2. Touch the SELECT icon to set the channel as a Select Memory channel. (Example: ★1)

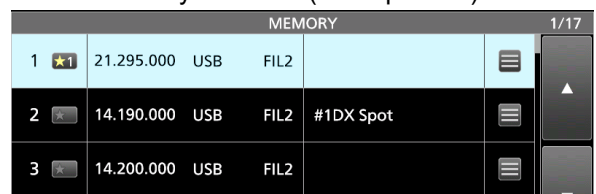

① Each touch selects "★1," "★2," "★3," or "(no icon)."

Select Memory scan

◇ Select Memory scan operation

1. Select the Memory mode.
2. Display the SCAN screen.

MENU » **SCAN**

3. Touch [MEMO] to start a regular Memory scan.

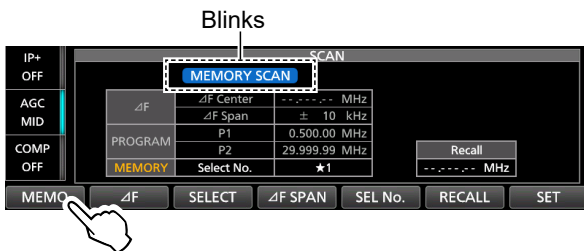

4. While scanning, touch [SEL No.] to select the Select Memory scan number. (Example: ★1)
- ① Touching [SEL No.] changes between “★1,” “★2,” “★3,” and “★1,2,3.”

- ★1: Channels specified as ★1 are scanned.
- ★2: Channels specified as ★2 are scanned.
- ★3: Channels specified as ★3 are scanned.
- ★1,2,3: Channels specified as ★1, ★2, or ★3 are scanned.

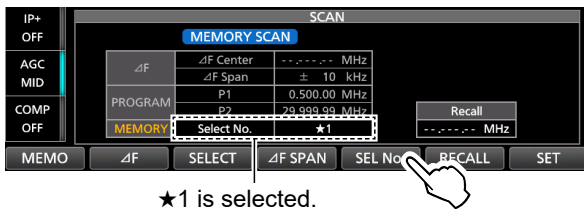

5. Touch [SELECT] to switch to the Select Memory scan.

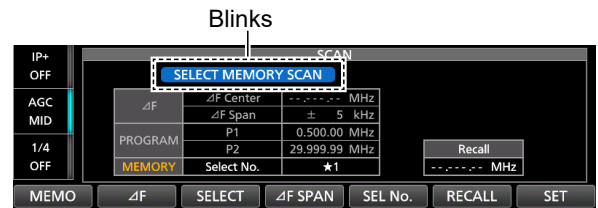

① Information

- When a signal is detected, the scan pauses according to the “SCAN Resume” setting, and then resumes.
 - To return to the regular Memory scan, touch [SELECT].
 - While scanning, touch [SEL No.] to select the Select Memory scan number.
 - To cancel the scan, touch [MEMO].
6. To close the SCAN screen, push **EXIT**.

Clearing all Select Memory channels

1. Touch [SELECT] for 1 second on the SCAN screen.
 - The SELECT ALL CLEAR screen is displayed.
2. Touch the Select Memory channel number to clear.



ΔF scan and Fine ΔF scan

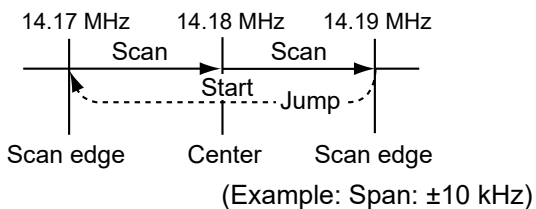

Repeatedly scans within the ΔF span area. The scan starts from the center frequency.

① In a Fine scan (Programmed or ΔF), the scan speed decreases when the squelch opens, but the transceiver keeps scanning. The scan tuning step changes to 10 Hz when the squelch opens.

◇ ΔF scan operation

1. In the Main band set the center frequency.
2. Set the operating mode and tuning step.
(Example: USB, 1 kHz)
① You can also change these settings while scanning.
3. Display the SCAN screen.
MENU » **SCAN**
4. Touch [ΔF SPAN] several times to select the span.
• Each touch changes the span.
5. Touch [ΔF] to start the ΔF scan.

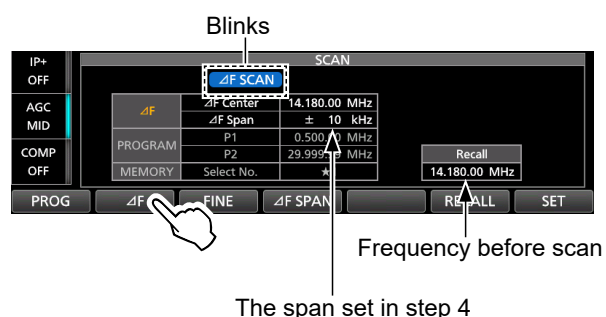

- ① When a signal is detected, the scan pauses according to the "SCAN Resume" setting, and then resumes.
- ① To turn the TS function to scan by the frequency step setting, touch the 100 kHz digit on the frequency readout.
- ① To cancel the scan, touch [ΔF] again.
6. To switch to the Fine ΔF scan, touch [FINE].

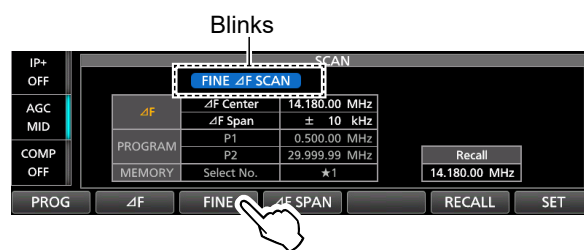

- The scan frequency step changes to 50 Hz.
 - ① To return to the ΔF scan, touch [FINE] again.
7. To close the SCAN screen, push **EXIT**.

Section 9

ANTENNA TUNER OPERATION (ADVANCED)

Antenna switching setting when operating with Dualwatch.....9-2

Antenna switching setting when operating with Dualwatch

You can connect a Transmit/Receive antenna to ANT1 ~ ANT4 for normal operation.

However, if you want to use separate antennas for transmit and receive, you need to set "RX-ANT." Or if you want to add an external device, such as a filter/pre-amplifier for receive, you need to set "RX-I/O."

To change the RX-ANT Connectors Type, open the "RX-ANT Connectors" screen, then select either "Connect Receive Antenna" or "Connect External RX Device."

MENU » ANTENNA > TYPE > RX-ANT Connectors

If you switch "RX-ANT Connectors" to the opposite type, (to "Connect External RX Device" or to "Connect Receive Antenna") the previous RX-ANT (or RX-I/O) memory settings for both the Main and Sub bands are cleared.

The "RX-I/O" settings are limited according to the antenna connector setting (ANT1 ~ ANT4), as follows.

Example:

When both the Main and Sub bands are using the same antenna (Example: ANT2) and "RX-ANT Connectors" is set to "Connect External RX Device," if Main is set to RX-I/O, Sub RX-I/O is forcibly set (temporarily) the same as the Main setting. Turning OFF RX-I/O on the Sub band clears the RX-I/O settings for both the Sub and the Main bands.

"RX-I/O" is set to both the Main and Sub bands.

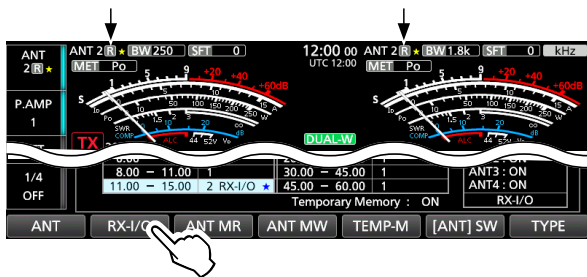

If you turn OFF RX-I/O on the Sub band that was forcibly set by the above operation, RX-I/O on the Main band is also forcibly turned OFF, and **R** is displayed.

"RX-I/O" is forcibly cleared. "RX-I/O" is OFF.

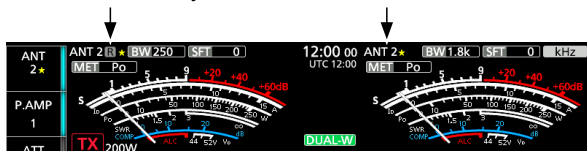

Example: Main band=ANT2, Sub band=ANT1

When the Main (ANT2) and Sub (ANT1) bands are set to different antennas, if you set RX-I/O to the Main band, and then you set RX-I/O to the Sub band, the previous Main band setting is forcibly cleared, and **R** is displayed. Setting Main back to RX-I/O forces SUB to be cleared, and **R** is displayed.

"RX-I/O" is set to ANT2. ANT1 is selected.

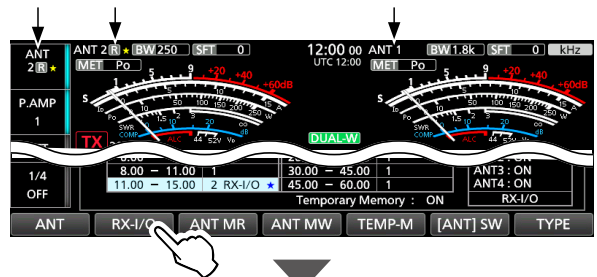

"RX-I/O" is forcibly turned OFF. "RX-I/O" is set.

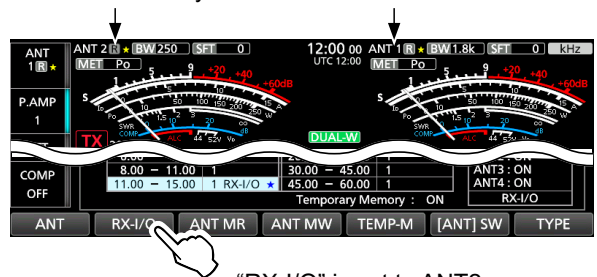

"RX-I/O" is set to ANT2.

The Main and Sub bands are not forcibly set or cleared when "RX-ANT Connectors" is set to "Connect Receive Antenna."

Section 10 CLOCK AND TIMERS (ADVANCED)

| | |
|--|------|
| NTP function..... | 10-2 |
| ◇ Manually synchronizing the internal clock..... | 10-2 |
| ◇ Using the NTP function..... | 10-2 |
| Setting the Timers..... | 10-3 |
| ◇ Setting the Sleep Timer..... | 10-3 |
| ◇ Setting the Daily Timer..... | 10-3 |
| ◇ Daily Timer setting items..... | 10-4 |

NTP function

The Network Time Protocol (NTP) function synchronizes the internal clock of the IC-7760 with a time management server.

① To use this function, an Internet connection and default gateway settings are necessary.

◇ Manually synchronizing the internal clock

Using this function, you can manually synchronize the internal clock by accessing a time management server.

1. Open the DATE/TIME screen.

MENU » **SET > Time Set > Date/Time**

2. Touch "<<NTP TIME SYNC>>."

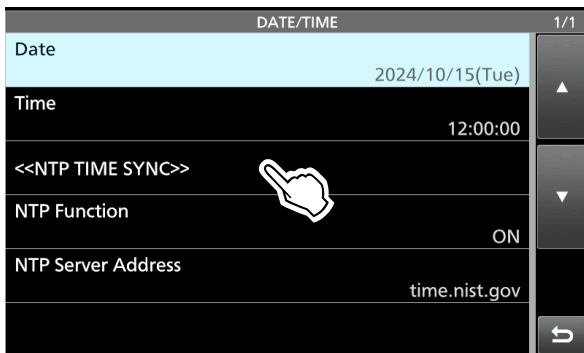

- "NTP Time Sync. Please wait..." is displayed.
- The transceiver starts accessing the NTP server address that is set in "NTP Server Address."

3. When "Time Sync completed." is displayed, touch [OK].
4. To close the DATE/TIME screen, push **EXIT** several times.

◇ Using the NTP function

By turning ON the NTP function, the transceiver automatically synchronizes the internal clock with the time management server.

① This function is set to ON by default.

1. Open the DATE/TIME screen.

MENU » **SET > Time Set > Date/Time**

2. Touch "NTP Function."

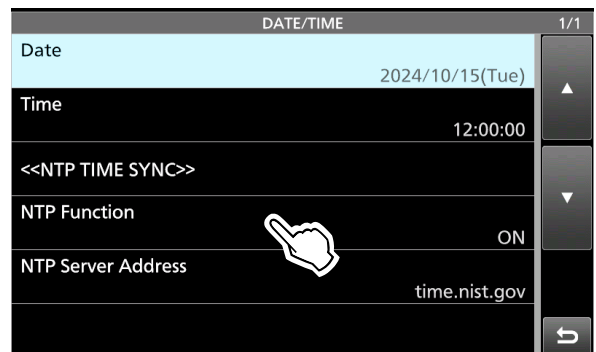

3. Select ON or OFF.
 - When ON is selected, the transceiver starts accessing the NTP server address that is set in "NTP Server Address."
4. To close the DATE/TIME screen, push **EXIT** several times.

Setting the Timers

◇ Setting the Sleep Timer

The Sleep Timer automatically turns OFF the transceiver power when the set time period has passed. You can set the timer to between 5 and 120 minutes, in 5 minute steps.

1. Push **TIMER** for 1 second.
2. Touch "Sleep Timer."

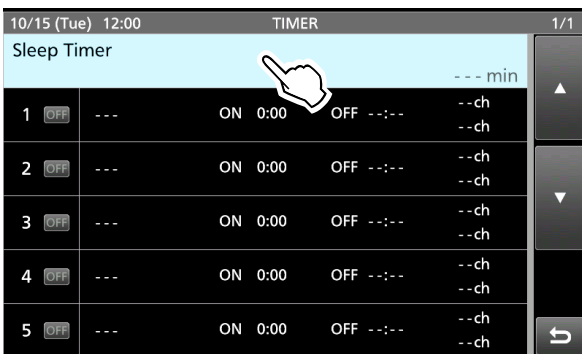

3. Rotate **MULTI** to set the sleep timer. (Example: 120 minutes)

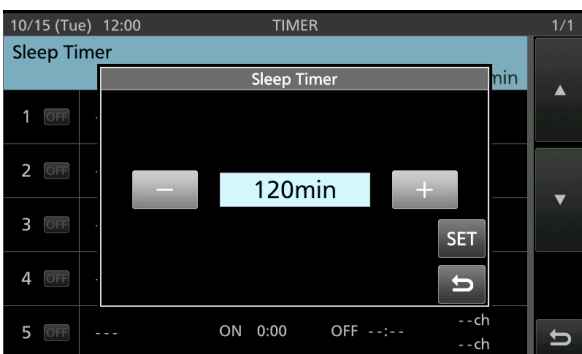

4. Touch [SET] to save the setting and to start the timer.
 - The timer indicator on **TIMER** lights white.
 - Approximately 10 seconds before the transceiver turns OFF, the indicator on **TIMER** starts blinking.
- ① After the transceiver turns OFF, the Sleep Timer set in step 3 is cleared.
- ① To pause and resume the timer while the timer is running, push **TIMER**.
5. To close the TIMER screen, push **EXIT**.

NOTE: The sleep timer may have an error of up to approximately 59 seconds.

◇ Setting the Daily Timer

The Daily Timer automatically turns the transceiver ON or OFF on the set day and time.

① You can set up to 5 timers.

1. Push **TIMER** for 1 second.
2. Touch the timer to set. (Example: 1)

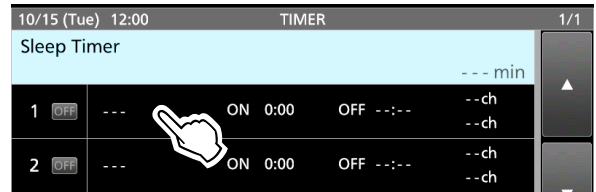

3. Rotate **MULTI** scroll through the setting items, and then touch an item to set.



① Each setting item is described on the next page.

① You can reset to the default setting or clear the setting in the QUICK MENU screen.

4. After setting the items, touch "<<Set>>" to save them.

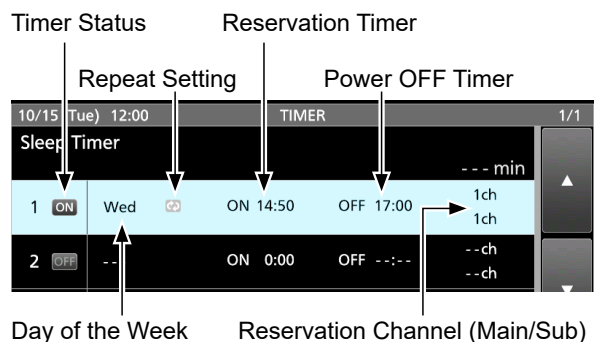
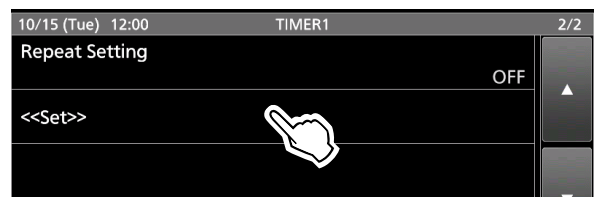

5. To close the TIMER screen, push **EXIT**.

10 CLOCK AND TIMERS (ADVANCED)

Setting the Timers

◇ Daily Timer setting items

NOTE: All of the following settings are not saved until you touch "<<Set>>."

Timer Status (Default: OFF)

Select ON to start the Daily Timer, and select OFF to stop the timer.

① To reset to the default setting, push **QUICK** and touch "Default."

Reservation Timer (Default: 0:00)

Sets the time to automatically turn ON the transceiver.

① To clear the setting, first set "Power OFF Timer," push **QUICK** and touch "Clear."

Power OFF Timer (Default: --:--)

Sets the time to automatically turn OFF the transceiver.

① To clear the setting, first set "Reservation Timer," and then push **QUICK** and touch "Clear."

NOTE: When "Power OFF Timer" is set to an earlier time than the "Reservation Timer" time, the transceiver will not be turned OFF automatically. To automatically turn the transceiver ON and OFF, set "Power OFF Timer" to a later time than the "Reservation Timer" time.

Example:

- Reservation Timer: 8:00
- Power OFF Timer: 9:30

Reservation Channel (MAIN) (Default: -- ch)

Reservation Channel (SUB) (Default: -- ch)

The Memory channel set in this item is automatically selected when the transceiver is automatically turned ON by the Reservation Timer, or the set time has come while the transceiver is turned ON.

① You cannot select a blank channel.

① To clear the setting, push **QUICK** and touch "Clear."

Day of the Week (Default: --)

Selects a day of the week to set the Daily Timer function.

① In order not to select a day, leave the item set to default.

When you reset to the default, push **QUICK**, and then touch "Clear."

Repeat Setting (Default: OFF)

Sets the Repeat Setting to ON or OFF.

When this item is set to ON, the timer is activated every selected day of the week, or every day if the Day of the Week item is not set.

① To clear the setting, push **QUICK** and touch "Clear."

<<Set>>

Touch to save all the timer settings for the selected timer.

Section 11 OTHER FUNCTIONS

| | |
|---|------|
| About the RF/SQL Control..... | 11-2 |
| About “USB SEND/Keying” | 11-2 |
| Protection function..... | 11-3 |
| Transmitter Lockout function | 11-3 |
| Measuring SWR | 11-4 |
| ◇ Spot measurement..... | 11-4 |
| ◇ Plot measurement | 11-5 |
| REF adjustment..... | 11-6 |
| Selecting the Display Font..... | 11-6 |
| Displaying my call sign | 11-6 |
| Screen Capture function..... | 11-7 |
| ◇ Setting the Screen Capture function | 11-7 |
| ◇ Capturing a screen | 11-7 |
| ◇ Viewing the captured screen | 11-7 |
| PRESET menu | 11-8 |
| ◇ Loading the preset memory..... | 11-8 |
| ◇ Editing the memory contents..... | 11-8 |
| About IP connection between the controller and RF deck..... | 11-9 |

About the RF/SQL Control

You can set the **RF/SQL** (outer) control type in the following item.

MENU » **SET > Function > RF/SQL Control**

- **Auto:** While in the AM or FM mode, used only as a squelch control. While in the SSB, CW, RTTY, or PSK mode, used only as an RF gain control.
- **SQL:** Used as only a squelch control.
 - ① RF gain is fixed at maximum sensitivity.
- **RF+SQL:** Used as an RF gain control, and a noise squelch or S-meter squelch.

When using as an RF gain/squelch control

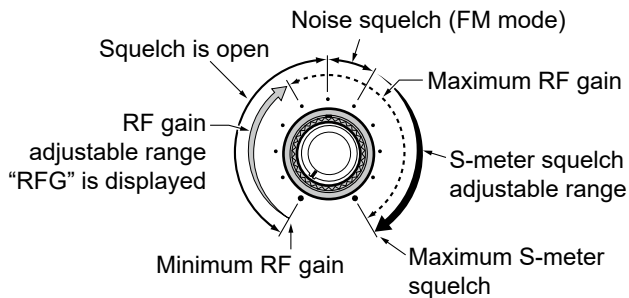

When using as an RF gain control (Squelch is fixed open: SSB, CW, RTTY, PSK only)

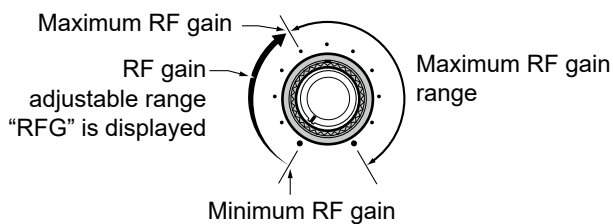

When using as a squelch control (RF gain is fixed at maximum.)

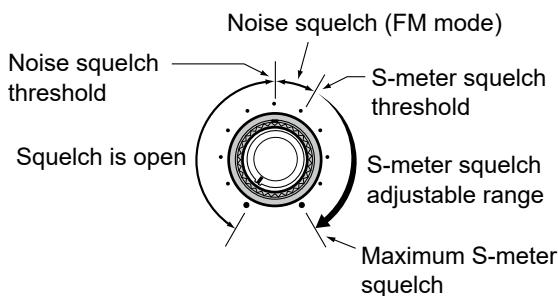

About "USB SEND/Keying"

You can control transmit, receive, and CW/RTTY keying from the PC through the USB port. Select the control port to be used for communication between the transceiver and PC in "USB SEND," "USB Keying (CW)," and "USB Keying (RTTY)" according to your operating needs.

MENU » **SET > Connectors > USB SEND/Keying**

The IC-7760 has two virtual COM ports, A and B. The transmit and receive control (USB SEND), CW Keying, or RTTY (FSK) Keying signals from the PC are assigned to the DTR/RTS terminals in the virtual port.

- ① When connecting to a USB port on your PC that is installed the USB driver, USB (A) and USB (B) are named "IC-7760 Serial Port A (CI-V)" and "IC-7760 Serial Port B."

USB SEND (Default: OFF)
USB Keying (CW) (Default: OFF)
USB Keying (RTTY) (Default: OFF)

- **OFF:** Turns OFF the function.
- **USB (A) DTR:** Uses the DTR terminal on USB (A).
- **USB (A) RTS:** Uses the RTS terminal on USB (A).
- **USB (B) DTR:** Uses the DTR terminal on USB (B).
- **USB (B) RTS:** Uses the RTS terminal on USB (B).

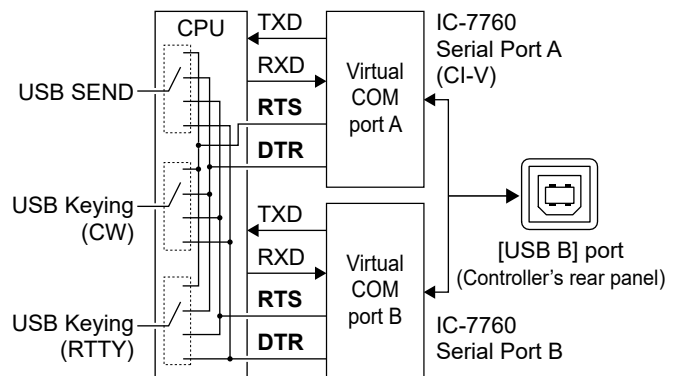

Protection function

The transceiver has a 2 step protection function to protect the final power amplifiers.

The function detects the power amplifier temperature and activates when the temperature becomes too high.

Power down transmission

Reduces the transmission output power.

- "LMT" is displayed while transmitting.

TX inhibit

Disables the transmitter.

- **TX** (Grayed out) is displayed instead of **TX** while the transmitter is disabled.

NOTE: If the function is activated, wait until the power amplifier cools down by using the transceiver only to receive.

- You can check the power amplifier temperature with the TEMP gauge in the Multi-function meter.

Transmitter Lockout function

When 2 Icom excitors that support the Transmitter Lockout function, including the IC-7760, are connected to the IC-PW2 to Single Operator Two Radios (SO2R) operation, the function prevents the simultaneous transmission from the excitors.

- ① When the TX inhibit command (16 66) is sent to the exciter connected to the IC-PW2's RF input connector set to the RX side (**INPUT** indicator lights green) or OFF (**INPUT** indicator is OFF), "INH" is displayed on the exciter's screen. When the exciter tries to transmit, "TX Inhibit" is displayed and cannot transmit.

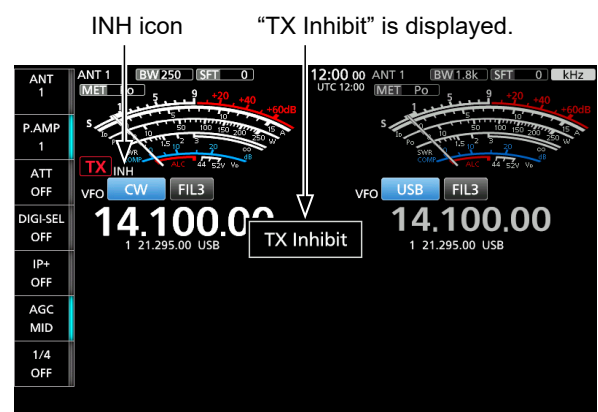

11 OTHER FUNCTIONS

Measuring SWR

The transceiver has an SWR meter. There are 2 ways to measure SWR. One way is a spot measurement, and the other is a plot measurement.

◆ Spot measurement

1. Turn OFF any antenna tuner.
 - ① Perform this step if you want to measure the SWR of the antenna itself.
2. Set the desired frequency band and a frequency in the portion of the band that you use the most.
3. Select the antenna connector to which the antenna you want to measure is connected.
4. Select the RTTY mode.
5. Set the RF power to 30 W or more in the Multi-function menu.
6. Touch the meter, and then touch [SWR] to display the SWR meter.

NOTE: Before transmitting, monitor the operating frequency to make sure you will not cause interference to other stations on the same frequency.

7. Hold down [PTT] to transmit, and then read the SWR on the meter.

The best match is within this range. (1.5 or less)

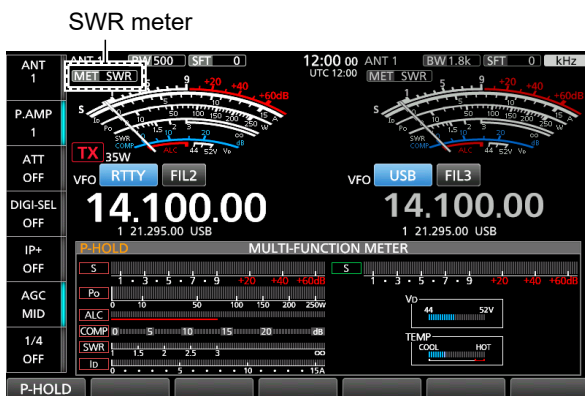
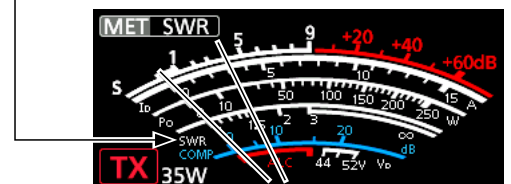
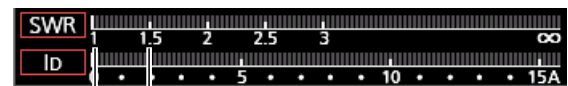

① If the SWR meter indicates 1.5 or less, the antenna is matched.

① If the SWR is a high value, adjust your antenna.

8. Release [PTT] to stop transmitting.

11 OTHER FUNCTIONS

Measuring SWR

◆ Plot measurement

You can measure the SWR over the entire set frequency range.

1. Set the desired frequency band.
2. Select the antenna connector to which the antenna you want to measure is connected.
3. Set the RF power to 30 W or more in the Multi-function menu.
4. Display the SWR GRAPH screen.

MENU » **SWR**

5. Set the center frequency for the SWR to measure. (Example: 14.080.00)
6. Touch **[SPAN]** several times to set the measuring span, or touch **[BAR]** several times to set the number of graph bars.

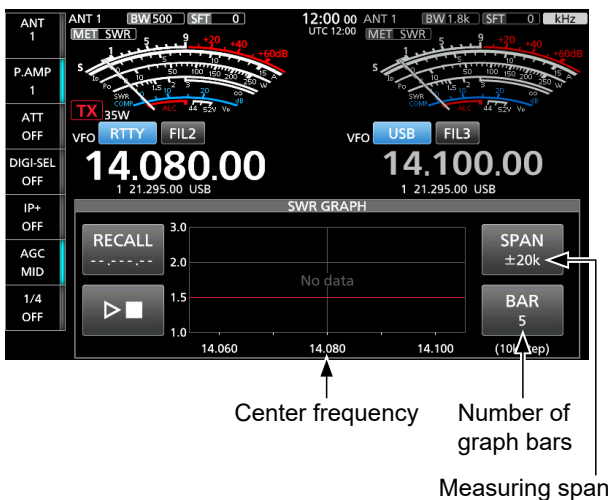

① You can select between ± 20 kHz, ± 50 kHz, ± 100 kHz, ± 200 kHz, ± 500 kHz, ± 1 MHz, and ± 2 MHz measuring spans.

① You can select between 3, 5, 7, 9, 11, and 13 graph bars.

7. Touch **[▶]** to start measuring.
 - Displays the frequency marker “▲” and the measurement frequency.

NOTE: Before transmitting, monitor the operating frequency to make sure you will not cause interference to other stations on the same frequency.

8. Hold down **[PTT]** to transmit.
 - The bar graph displays the SWR.
 - ① When the Break-in function is ON in the CW mode, you can use a straight key or paddle to transmit.

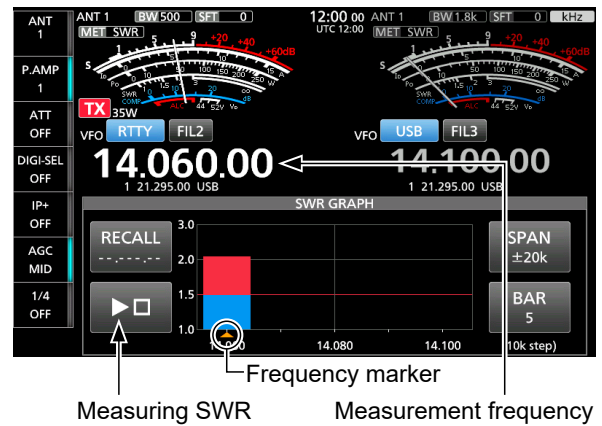

9. Release **[PTT]** to stop transmitting.
 - ① When using a straight key or paddle, stop keying.
10. Repeat steps 8 and 9 to measure the SWR over the entire frequency range.

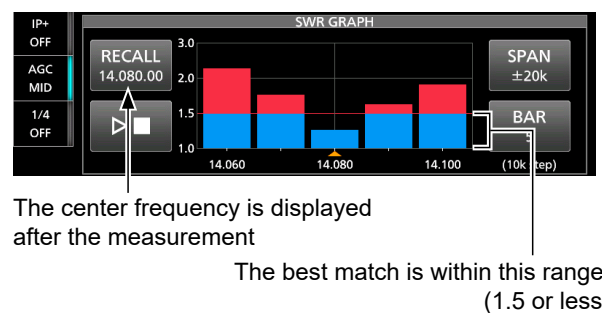

TIP:

- Rotate **(MAIN DIAL)** to move the frequency marker “▲” to the current transmit frequency.
- “<<” (low) or “>>” (high) is displayed when the transmitted frequency is out of the displayed range.
- Touch **[RECALL]** for 1 second to move the frequency marker “▲” back to the center frequency.
- Touch the bar graph to delete the measured SWR.

11 OTHER FUNCTIONS

REF adjustment

You can perform a rough frequency calibration by receiving the radio station WWV, WWVH, or other frequency signals.

NOTE:

- The transceiver has been adjusted and tested at the factory before being shipped. You should not have to manually recalibrate it.
- Before performing a frequency calibration, you have to set “Calibration Marker” to ON.
- Spurious signal waveforms may be displayed while the Calibration Marker is ON.



① Before performing a frequency calibration, set the following items as described in the table below.

| | |
|----------------------------|-------------------------------------|
| Operating mode | USB |
| AF → RF/SQ | Decent audibility |
| AF → RF/SQ | Maximum RF gain |
| TWIN PBT CLR | Reset by holding down for 1 second. |
| RIT , TX | OFF (No icon) |

1. Set the frequency to the standard frequency station minus 1 kHz.
① If receiving WWV or WWVH (at 15.00000 MHz) as your standard frequency, set the operating frequency to 14.99900 MHz.
2. Set “Calibration Marker” to ON.
MENU » **SET > Function > Calibration Marker**
3. Open the “REF Adjust” screen.
MENU » **SET > Function > REF Adjust**
4. Rotate **MULTI** to adjust for a zero beat with the received standard signal.
① “Zero beat” means that the exact same frequencies are set to 2 signals, resulting in a single tone being transmitted.
5. Set “Calibration Marker” to OFF.
6. To close the FUNCTION screen, push **EXIT** several times.

Selecting the Display Font

You can select between 2 frequency readout fonts.

1. Open the “Display Font” screen.
MENU » **SET > Display > Display Font**
2. Select the display font type.
 - Square

 - Round (Default)

3. To close the DISPLAY screen, push **EXIT** several times.

Displaying my call sign

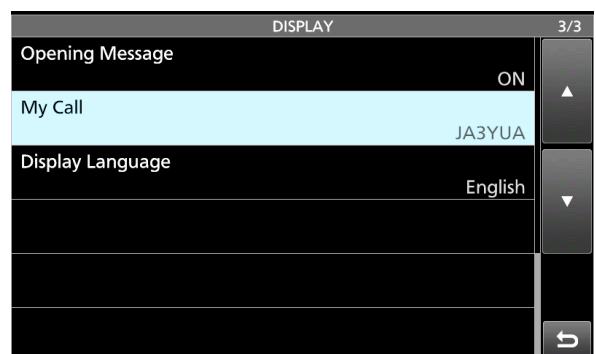
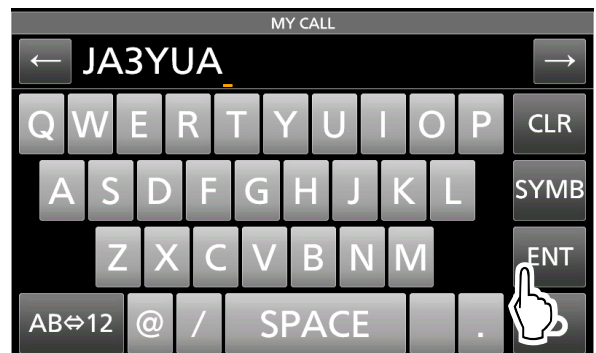
You can set to display your own call sign at power ON. (Example: displaying the call sign JA3YUA)

1. Open the MY CALL screen.
MENU » **SET > Display > My Call**
2. Enter “JA3YUA,” and touch [ENT] to save.



3. To close the DISPLAY screen, push **EXIT** several times.

Screen Capture function

You can capture the transceiver display (Main and Sub screen) onto an SD card or a USB flash drive. Most of the screens used in this manual are captured using this function.

However, some displays cannot be captured.

NOTE: To use the Screen Capture function, an SD card or a USB flash drive (user supplied) is required.

◇ Setting the Screen Capture function

- Open the "Screen Capture [POWER] Switch" screen.
MENU » SET > Function > **Screen Capture [POWER] Switch**
- Touch "ON" to turn ON the Screen Capture function.
- Select the SD card or USB flash drive to save screen capture data in "Screen Capture Storage Media."
MENU » SET > Function > **Screen Capture Storage Media**
- Select the screen capture file type in "Screen Capture File Type."
MENU » SET > Function > **Screen Capture File Type**
- To close the FUNCTION screen, push **EXIT** several times.

TIP: You can also assign the Screen Capture function to the [Print Screen] key on the USB keyboard.

MENU » SET > Function > **Screen Capture Keyboard [Print Screen]**

◇ Capturing a screen

- Display the desired screen to capture.
 - Push **POWER** to capture the screen.
 - The captured screen is saved onto the selected media.
- ① If "Screen Capture Keyboard [Print Screen]" is set to ON, push [Print Screen] on the keyboard.

◇ Viewing the captured screen

- Open the SCREEN CAPTURE VIEW screen.

MENU » SET > SD Card > **Screen Capture View**

MENU » SET > USB Flash Drive > **Screen Capture View**

- The capture list is displayed.
- The latest screen capture is at the top of the list.

- Touch the desired screen capture to display it.

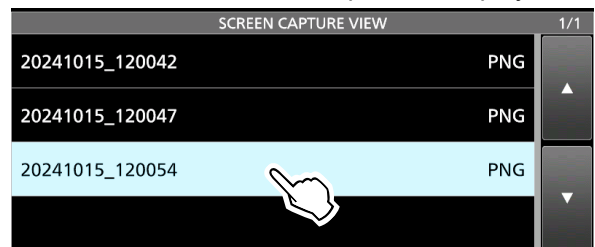

- The screen captures are displayed on the Main and Sub screens, and the indicator on **NR** blinks white.

- ① While a screen capture is displayed, you can scroll through all the screen captures by rotating **MULTI**.
- To close the SCREEN CAPTURE VIEW screen, push **EXIT** several times.

Checking the file information and deleting a file

- Touch the screen capture that you want to view or delete for 1 second.

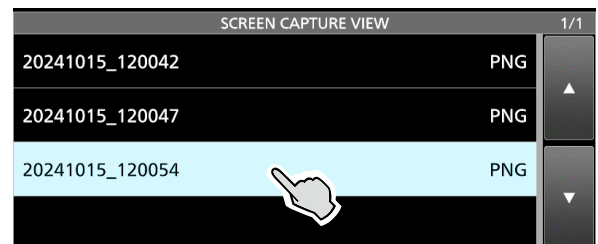

- Touch an item from "File Information," "Delete," and "Delete All."

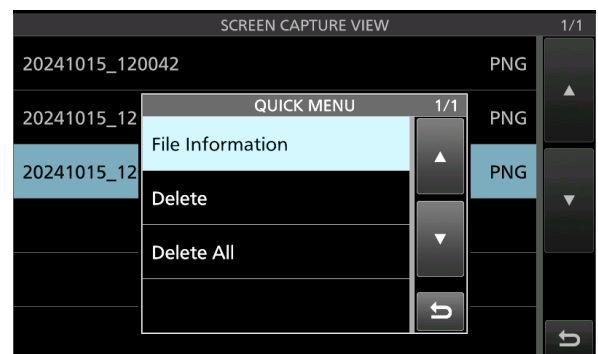

- File Information:** Displays the file name, size, and date of the selected screen capture.
- Delete:** Deletes the selected file.
- Delete All:** Deletes all files.

PRESET menu

You can save the combination of the following settings for the data mode to quickly change the settings, depending on your operating needs.

| | |
|---------------------|------------------------|
| Preset Name | DATA3 MOD |
| Mode | SSB-D TX Bandwidth |
| Filter | DATA OFF MOD |
| Filter BW | COMP |
| Filter Type (HF) | SSB TBW |
| Filter Type (50M) | SSB TX Bandwidth |
| USB Output Select | USB SEND |
| USB AF Output Level | USB Keying (CW) |
| USB AF SQL | USB Keying (RTTY) |
| USB IF Output Level | CI-V Address |
| USB MOD Level | CI-V Transceive |
| DATA1 MOD | CI-V USB (A) Echo Back |
| DATA2 MOD | |

① The transceiver has a total of 5 memories.

◇ Loading the preset memory

1. Open the PRESET screen.

MENU » **PRESET**

2. Touch the preset memory to load.
(Example: 2: FT8)



3. Touch [YES].
 - The selected preset memory is loaded, and “In Use” is displayed on the PRESET screen. If you change the transceiver settings, and they do not match the contents of the preset memory, “In Use” disappears.

① Touching [UNLOAD] returns the transceiver settings to those set before loading the preset memory.



NOTE:

- You cannot load the preset memory whose “Mode” is checked while selecting a blank Memory channel in the Memory mode.
- You cannot load a preset memory that is displayed as “(BLANK).”

◇ Editing the memory contents

NOTE: You cannot edit the preset memory that is in use. To edit it, first touch [UNLOAD], and then edit the memory.

1. On the PRESET screen, touch a preset memory to edit for 1 second.
 - Opens the QUICK MENU screen.
2. Touch “Edit the Preset Memory.”
 - ① When touching “Save to the Preset Memory,” all of the contents are set to the current settings before editing.
3. Touch the check box to select whether or not to load the item.
 - “✓” is displayed on the left side of the loading item.
4. Touch the item name, and then touch the option to set.
5. Repeat steps 3 and 4 to edit the preset memory.
6. Touch “<<Write>>.”
7. Touch [YES].

TIP: Depending on your software, you may need to change the “CI-V Address” setting. For example, if you use a software that is not compatible with the IC-7760, you may be able to use the software by setting “CI-V Address” to another transceiver’s address.

About IP connection between the controller and RF deck

The IC-7760's controller and RF deck connect using the IP method. The IC-7760 has 3 IP addresses described to the right, and when you connect the controller and RF deck through a network, all of 3 IP addresses are used.

| | |
|------------|-------------------------|
| Controller | IP Address (LAN) |
| | IP Address (Controller) |
| RF deck | IP Address (RF Deck) |

- ① When you connect the controller and RF deck directly with the supplied control cable, settings of 3 IP addresses are not used for the connection.
- ① When using the NTP function or remotely controlling by a PC using the RS-BA1, "IP Address (LAN)" is used to connect to a network.

There are 4 connection methods.

- ① in is a setting in the Set mode. Not used addresses are grayed in the images.

MENU » **SET > Network**

NOTE: DO NOT connect 2 or more controllers, or other devices to the RF deck's [CONTROLLER].

Connecting the controller and RF deck directly:

The controller and RF deck are directly connected with a supplied control cable.

- ① You have to connect like this before using the transceiver for the first time, or after performing an All reset.
The controller and RF deck are automatically paired after the RF deck is turned ON, and then the controller is turned ON.
- ① The IP addresses are not used for the connection.

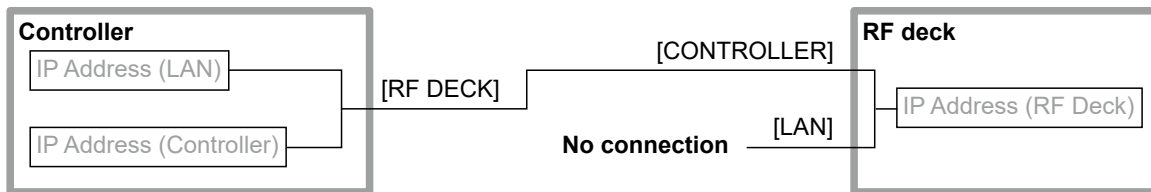

Connecting the controller and RF deck directly, and connecting the RF deck to a network:

The controller and RF deck are directly connected with a supplied control cable, and the RF deck's [LAN] port is connected to a network switch.

- ① "IP Address (LAN)" is used to connect to a network. Other IP addresses are not used to connect the controller and RF deck.

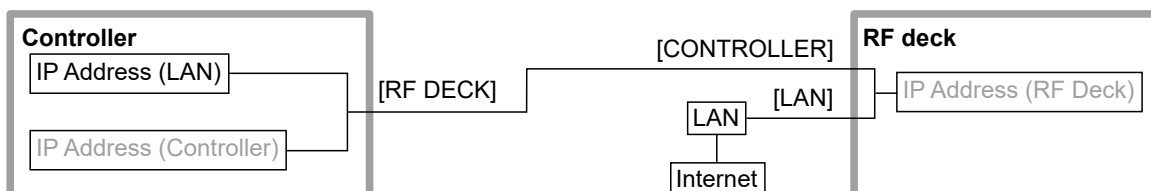

11 OTHER FUNCTIONS

About IP connection between the controller and RF deck

Connecting the controller and RF deck through a network:

The controller and RF deck are connected through a network.

① All 3 IP addresses are used for the connection.

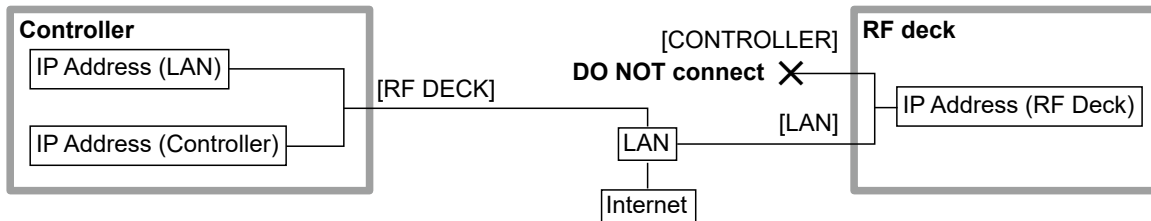

NOTE:

- You need to connect the controller and RF deck directly to pair them before using the transceiver for the first time, or after performing an All reset. If you do not, they cannot be connected. ("The RF deck is not detected." is displayed and **RF** blinks.)
- Use networking devices and ethernet cables that are compatible with Gigabit Ethernet.
- Operation cannot be guaranteed if:
 - Connecting through a wireless LAN network.
 - Using even one networking device or ethernet cable that is compatible only with Fast Ethernet or earlier, between the controller and RF deck.

Connecting the controller and RF deck between different segments:

The controller and RF deck are connected between different segments (Example: LAN 1 and LAN 2).

① The RF deck cannot obtain a dynamic IP address from the DHCP server. Ask the network administrator for the network settings.

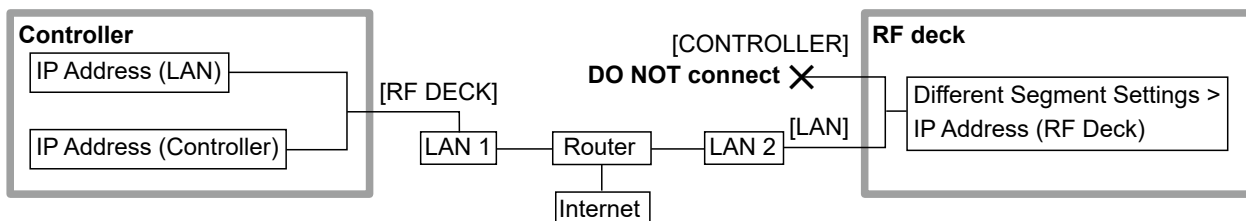

TIP: To use this connection method

1. Turn ON the transceiver and confirm the controller and RF deck are connected.
 - The indicator on the RF deck's front panel lights blue.
2. Set "Connection from Different Segment" to "ON," and then set the items in the "Different Segment Settings" menu.
MENU » **SET > Network > Different Segment Settings**
3. Restart the transceiver.

NOTE:

- Use networking devices and ethernet cables that are compatible with Gigabit Ethernet.
- Operation cannot be guaranteed if:
 - Connecting through a wireless LAN network.
 - Using even one networking device or ethernet cable that is compatible only with Fast Ethernet or earlier, between the controller and RF deck.
- The controller and RF deck cannot be connected if NAT/IP masquerading or a packet filter is used on a router.

Section 12 MAINTENANCE (ADVANCED)

| | |
|---|------|
| Replacing the clock backup battery..... | 12-2 |
| Touch Screen Calibration function..... | 12-3 |

Replacing the clock backup battery

The IC-7760's controller has a lithium backup battery (CR2032) for the internal clock and timer functions. When the backup battery is exhausted, the transceiver normally works but cannot retain the current time.

For Users in California (U.S.A.)

This CR2032 Lithium Battery contains Perchlorate Material—special handling may apply. See <https://dtsc.ca.gov/perchlorate/>

⚠ WARNING! DISCONNECT the power adapter from the outlet before removing the controller's cover.

1. Detach the desktop stand from the controller.
2. Remove the 8 screws from the controller's rear cover.

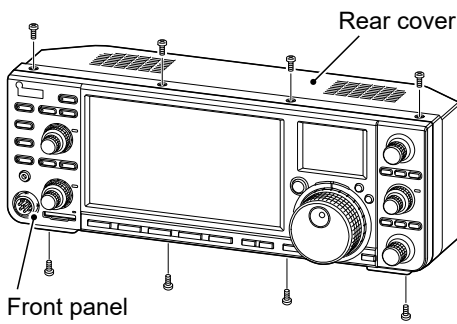

6. Return the front panel to the original position, reinstall the 8 screws, and then connect the power adapter to the outlet.
7. Turn ON the transceiver, and then set the date and time in the DATE/TIME screen.

MENU » **SET > Time Set > Date/Time**

3. Pull the front panel out of the rear cover.
 - ① Be careful not to stretch the speaker cables.
4. While lightly lifting the metal fitting (+ terminal) of the battery holder in the direction of ①, remove the old battery in the direction of ②.
 - ① If you cannot remove the battery with your fingers, use a thin, non-metallic stick, such as a toothpick.

CAUTION: DO NOT use metal objects, such as a tweezer. This could damage the controller.

5. While lightly placing the new battery in the direction of ③, push it into the battery holder.

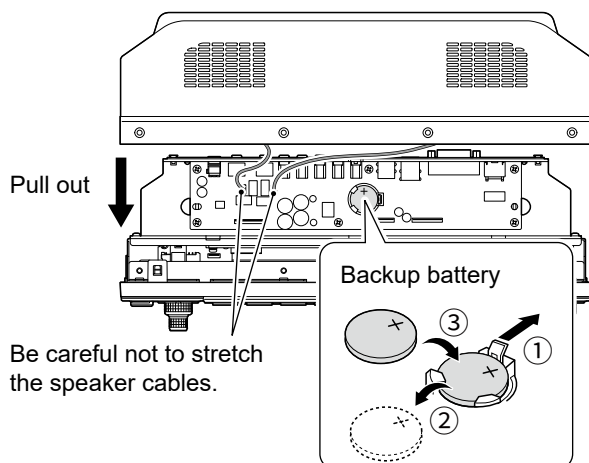

Touch Screen Calibration function

When the screen does not respond, or the transceiver does not work correctly after touching the screen, the touched point and the detected point may be different. In that case, the Touch Screen Calibration function helps to correct the touch screen sensing accuracy.

1. Open the OTHERS screen.

MENU » **SET > Others**

2. Touch "Touch Screen Calibration."



- A dot appears on the screen.

3. Touch the dot that is displayed on the Main screen.

Touch the displayed dot.



- A new dot appears in another location.

4. Repeat step 3.
 - After finishing the Main screen calibration, a dot appears in the Sub screen.

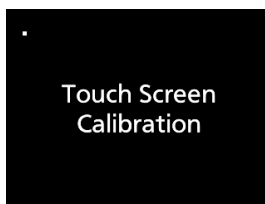

Sub screen

- When both Main and Sub screen calibration is complete, the transceiver returns to the OTHERS screen.

TIP: When the touch screen is not accurate, and you cannot access the OTHERS screen.

Do the following steps to display the "Touch Screen Calibration" screen.

1. Turn OFF the transceiver.
2. While holding down **MENU** and **EXIT**, push **POWER** to display the "Touch Screen Calibration" screen.
3. Repeat steps 3 and 4 in the left column.
4. Touch the frequency readout or a key on the touch screen to confirm that the touch screen is working correctly.

Section 13 UPDATING THE FIRMWARE

| | |
|---------------------------------------|------|
| General..... | 13-2 |
| ◇ About updating the firmware | 13-2 |
| ◇ Checking the firmware version | 13-2 |
| ◇ Preparation..... | 13-3 |
| Updating the firmware | 13-4 |

General

◇ About updating the firmware

You can update the IC-7760's firmware using an SD card or a USB flash drive. Updating the firmware adds new functions and/or improves performance parameters.

You can download the latest firmware from the Icom website.

<https://www.icomjapan.com/support/>

IMPORTANT: To update the firmware, first format your SD card or a USB flash drive using the IC-7760. Then copy the downloaded firmware data from your PC into the "IC-7760" folder on the card or flash drive.

◇ Checking the firmware version

Check the IC-7760's firmware version when you turn ON the transceiver.



The firmware version is displayed.

TIP: You can also check the firmware version on the VERSION screen.

MENU » SET > Others > Information > **Version**

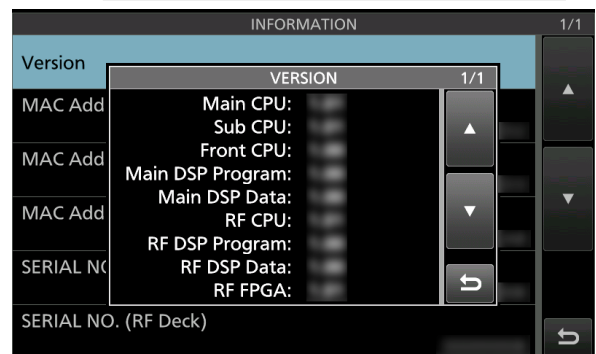

13 UPDATING THE FIRMWARE

General

◇ Preparation

Access the following URL and download the firmware file.

<https://www.icomjapan.com/support/>

① These instructions are based on Microsoft Windows 11.

1. Click the “Firmware/Software” link.



2. Enter “IC-7760” into the Search box, and then click [Search].

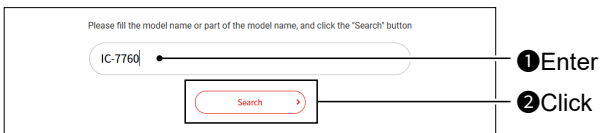

3. Click the desired firmware file link.
4. Carefully read “Regarding this Download Service.” Click “Agree,” and then click [Download].

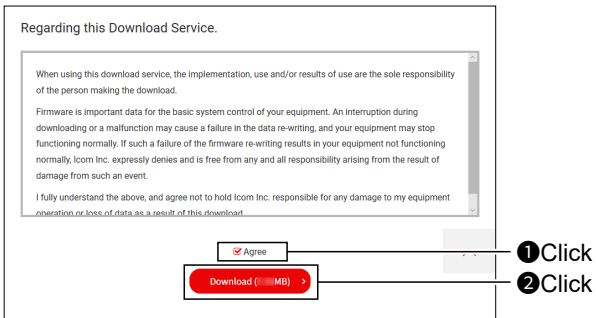

- The file starts downloading.

5. After the download is complete, click “Open file.”
① Download steps may differ, depending on the PC settings.

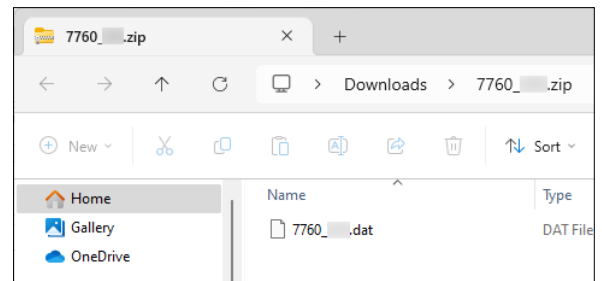
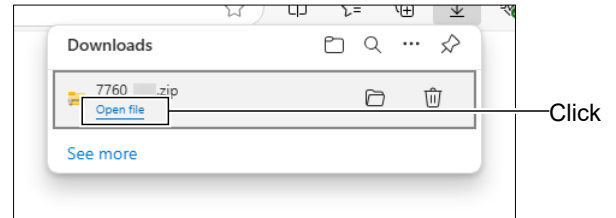

- ① In the “7760_*” folder, “7760_*.dat” is created.
* Represents the release number.

Updating the firmware

CAUTION: NEVER turn OFF the transceiver or disconnect the RF deck and controller while updating the firmware. If you turn OFF the transceiver, and a power failure occurs, or disconnect the RF deck and controller while updating, the transceiver firmware may be damaged, and you may have to send the transceiver back to the nearest Icom distributor for repair. This type of repair is out of warranty, even if the transceiver warranty period is still valid.

- Copy the downloaded firmware data into the "IC-7760" folder on an SD card or a USB flash drive. (Example: SD card)

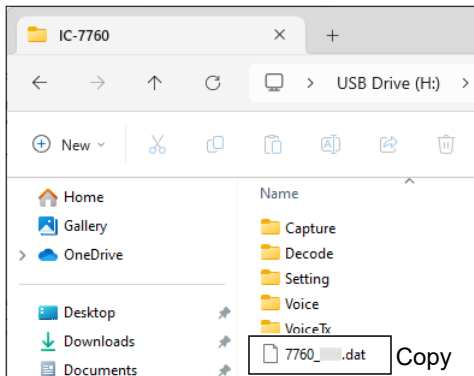

- Insert the SD card or USB flash drive into the transceiver.
- Display the SD CARD or USB FLASH DRIVE screen.
 - MENU** » **SET > SD Card**
 - MENU** » **SET > USB Flash Drive**
- Touch "Firmware Update."

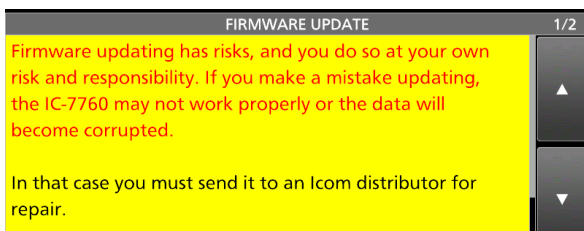
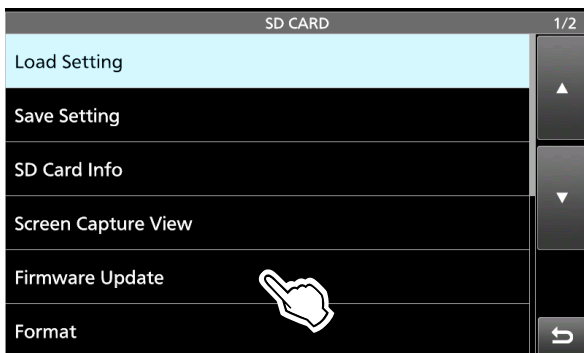

- Touch [▼] to scroll the screen and read all the precautions.
- After you read and agree with all the precautions, touch [YES].

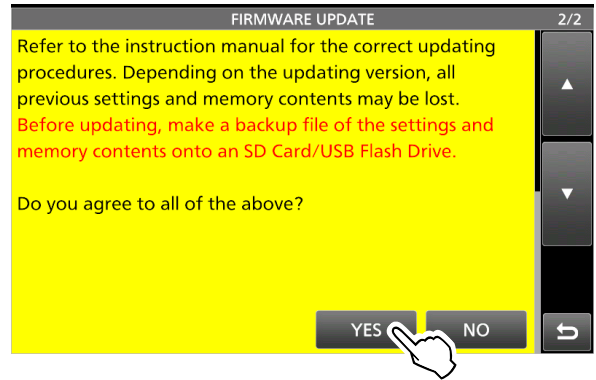

- The confirmation dialog is displayed. When you touch [YES], the backup file is made on the SD card, and then the Firmware selection screen is displayed.
- Touch the Firmware (Example: 7760_*).
* Represents the release number.

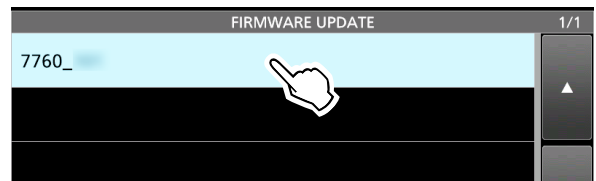

- The final confirmation screen is displayed. Carefully read all the displayed precautions.
- After you read and agree with all the precautions, touch [YES] for 1 second.

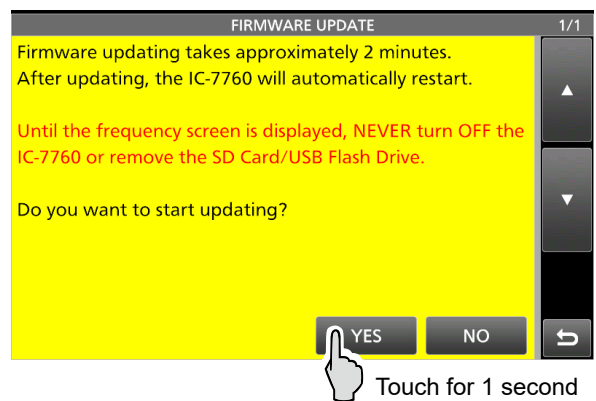

- The updating starts.
- When the update is completed, "Firmware updating has completed." is displayed in the dialog.
 - The transceiver will automatically restart.
- ① After the updating finishes, the operating screen is displayed.

TIP: If "Firmware updating has stopped because the RF deck connection was lost." is displayed, restart the transceiver, and then retry updating the firmware.

