



BASIC MANUAL

HF/50 MHz TRANSCEIVER
IC-7760



Thank you for choosing this Icom product. This product is designed and built with Icom's state of the art technology and craftsmanship. With proper care, this product should provide you with years of trouble-free operation.

IMPORTANT

READ ALL INSTRUCTIONS carefully and completely before using the transceiver.

SAVE THIS INSTRUCTION MANUAL— This instruction manual contains basic operating instructions for the IC-7760. For advanced operating instructions, see the Advanced manual for details. The Advanced manual is available at the following internet address:
<https://www.icomjapan.com/support/>

FEATURES

- **RF Direct Sampling System**
 The IC-7760 employs an RF direct sampling system. RF signals are directly converted to digital data in the ADC, and then processed in the FPGA. This system is a leading technology, marking an epoch in amateur radio.
- **The separate configuration**
 The IC-7760 consists of the controller and the RF deck.
- **2 identical receivers and speakers**
 The IC-7760 has 2 independent receiver circuits and speakers for the Main and Sub bands.
- **A built-in DIGI-SEL unit**
 Both the Main and Sub receivers have built-in DIGI-SEL (digital preselector) units. These reject interfering signals.
- **Real-Time Spectrum Scope**
 Displays the Main and Sub band conditions. It provides class-leading performance in resolution, sweep speed and provides a 100 dB dynamic range.
- **2 touch panel color displays**
- **A built-in automatic antenna tuner**
- **Multi-function control for easy settings**
- **Digital Pre-Distortion (DPD) function that reduces the distortion of the SSB and AM mode signals**
- **I/Q baseband signal output port**
- **IP remote control capability with the optional RS-BA1 Version 2 IP REMOTE CONTROL SOFTWARE**
- **Remote encoder capability with the optional RC-28 REMOTE ENCODER**
- **Dualwatch operation**

SUPPLIED ACCESSORIES

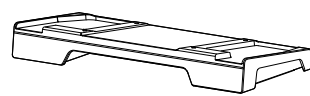

Desktop stand

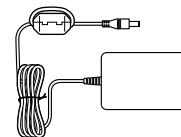

Power adapter for Controller
(1.8 m: 5.9 ft)

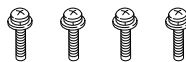

Assembled screws
(M3 × 12 mm)

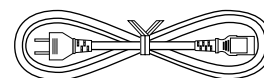

Power cable for RF deck
(2 m: 6.6 ft)



CW key plugs
(3.5 mm: 1/8 inch stereo)

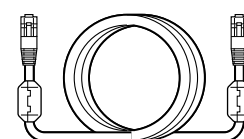

Control cable
(3 m: 9.8 feet)



ACC plug
(7-pin)



ACC plug
(8-pin)

① Some accessories are not supplied, or the shape is different, depending on the transceiver version.

TRADEMARKS

Icom and the Icom logo are registered trademarks of Icom Incorporated (Japan) in Japan, the United States, the United Kingdom, Germany, France, Spain, Russia, Australia, New Zealand, and/or other countries.

All other products or brands are registered trademarks or trademarks of their respective holders.

This product includes RTOS "RTX" software, and is licensed according to the software license.

This product includes "zlib" open source software, and is licensed according to the open source software license.

This product includes "libpng" open source software, and is licensed according to the open source software license.



This product includes "mbed TLS" open source software, and is licensed according to the open source software license.

Refer to the "About the Licenses" page at the end of the manual in English for information on the open source software being used in this product.

About weld lines

This product's surfaces may have streaks called "weld lines," that occur during the molding process, and are not cracks or flaws.

EXPLICIT DEFINITIONS

WORD	DEFINITION
 DANGER!	Personal death, serious injury or an explosion may occur.
 WARNING!	Personal injury, fire hazard or electric shock may occur.
CAUTION	Equipment damage may occur.
NOTE	Recommended for optimum use. No risk of personal injury, fire or electric shock.

Icom is not responsible for the destruction, damage to, or performance of any Icom or non-Icom equipment, if the malfunction is because of:

- Force majeure, including, but not limited to, fires, earthquakes, storms, floods, lightning, or other natural disasters, disturbances, riots, war, or radioactive contamination.
- The use of Icom transceivers with any equipment that is not manufactured or approved by Icom.

DISPOSAL



The crossed-out wheeled-bin symbol on your product, literature, or packaging reminds you that in the European Union, all electrical and electronic products, batteries, and accumulators (rechargeable batteries) must be taken

to designated collection locations at the end of their working life. Do not dispose of these products as unsorted municipal waste.

Dispose of them according to the laws in your area.

ABOUT CE AND DOC

 Hereby, Icom Inc. declares that the versions of IC-7760 which have the “CE” symbol on the product, comply with the essential requirements of the Radio Equipment Directive, 2014/53/EU, and the restriction of the use of certain hazardous substances in electrical and electronic equipment Directive, 2011/65/EU. The full text of the EU declaration of conformity is available at the following internet address:

<https://www.icomjapan.com/support/>

These versions also comply with the essential requirements of the Battery Regulation, (EU) 2023/1542.

ABOUT UKCA DOC

To obtain the UKCA Declaration of Conformity, please contact Icom UK Limited by email at info@icomuk.co.uk or alternatively call + 44(0) 1227 741741.

FCC INFORMATION

This equipment has been tested and found to comply with the limits for a Class B digital device, pursuant to part 15 of the FCC Rules.

These limits are designed to provide reasonable protection against harmful interference in a residential installation. This equipment generates, uses and can radiate radio frequency energy and, if not installed and used in accordance with the instructions, may cause harmful interference to radio communications. However, there is no guarantee that interference will not occur in a particular installation. If this equipment does cause harmful interference to radio or television reception, which can be determined by turning the equipment off and on, the user is encouraged to try to correct the interference by one or more of the following measures:

- Reorient or relocate the receiving antenna.
- Increase the separation between the equipment and receiver.
- Connect the equipment into an outlet on a circuit different from that to which the receiver is connected.
- Consult the dealer or an experienced radio/TV technician for help.

CAUTION: Changes or modifications to this device, not expressly approved by Icom Inc., could void your authority to operate this device under FCC regulations.

This device complies with part 15 of the FCC Rules. Operation is subject to the condition that this device does not cause harmful interference.

WARNING: MODIFICATION OF THIS DEVICE TO RECEIVE CELLULAR RADIOTELEPHONE SERVICE SIGNALS IS PROHIBITED UNDER FCC RULES AND FEDERAL LAW.

For Canada:

This device contains licence-exempt transmitter(s)/ receiver(s) that comply with Innovation, Science and Economic Development Canada (ISED)’s licence-exempt RSS(s). Operation is subject to the following two conditions: (1) this device may not cause interference, and (2) this device must accept any interference, including interference that may cause undesired operation of the device.

ABOUT SPURIOUS SIGNALS

Spurious signals may be received on some frequencies. These are made in the internal circuit and does not indicate a transceiver malfunction.

ABOUT THE TOUCH SCREEN

◇ Touch operation

In the Advanced manual and the Basic manual, the touch operation is described as shown below, with the beep tone ON.



Touch

If the display is touched briefly, one short beep sounds.



Touch for 1 second

If the display is touched for 1 second, one short and one long beep sound.

◇ Touch screen precautions

- The touch screen may not properly work when the LCD protection film or sheet is attached.
- Touching the screen with your finger nails, sharp-tipped object and so on, or touching the screen hard may damage it.
- Tablet PC operations such as flick, pinch in, and pinch out cannot be performed on this touch screen.

◇ Touch screen maintenance

- If the touch screen becomes dusty or dirty, wipe it clean with a soft, dry cloth.
- When you wipe the touch screen, be careful not to push it too hard or scratch it with your finger nails. Otherwise you may damage the screen.

ABOUT THE MANUALS

You can use the following manuals to understand and operate this transceiver. (As of October 2024)

TIP: You can download each manual and guide from the Icom website.
<https://www.icomjapan.com/support/>
Enter "IC-7760" into the Search box in the site.

- **Basic manual (This manual)**
Instructions for basic operations.
- **Advanced manual (PDF type)**
Instructions for advanced operations in English.
- **CI-V Reference guide (PDF type)**
Describes the control commands used in remote control operation (serial communication with CI-V) in English.
- **I/Q Port Reference guide (PDF type)**
Describes the I/Q data and control commands used in remote control operation in English.
- **Information for the HDSDR application (PDF type)**
Describes how to use the IC-7760 with the HDSDR application in English.

For Reference

- **HAM Radio Terms (PDF type)**
A glossary of HAM radio terms in English.

ABOUT THE INSTRUCTIONS

The Advanced and Basic manuals are described in the following manner.

“ ” (Quotation marks):

Used to indicate icons, setting items, and screen titles displayed on the screen.
The screen titles are also written in uppercase letters.
(Example: FUNCTION screen)

[] (brackets):

Used to indicate keys.

Routes to the Set modes and Setting screens

Routes to the Set mode, Setting screens and the setting items are described in the following manner.

MENU » SET > Time Set > Date/Time > **Date**

Instruction example:

◇ **Setting the date**

1. Open the “Date” screen.
MENU » SET > Time Set > Date/Time > **Date**
2. Touch [+] or [-] to set the date.

Detailed instruction:

1. Push **MENU**.

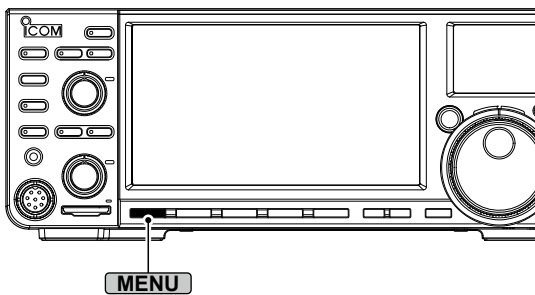

2. Touch [SET].

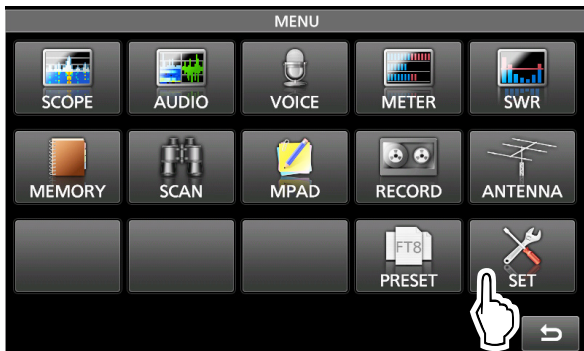

3. Touch “Time Set.”

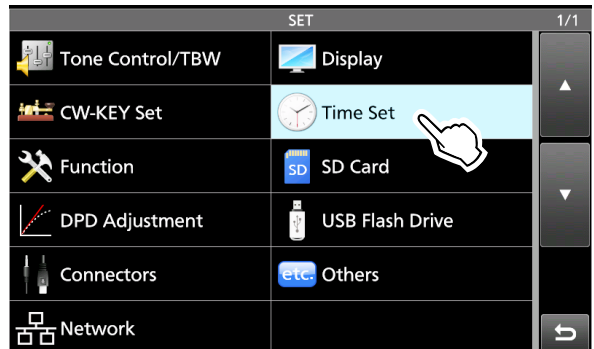

4. Touch “Date/Time.”
 - Opens the DATE/TIME screen.
5. Touch “Date.”

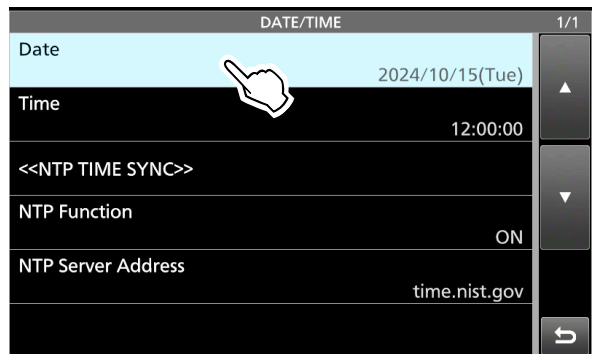

6. Touch [+] and [-] to set the date.
7. Touch [SET] to set the date.

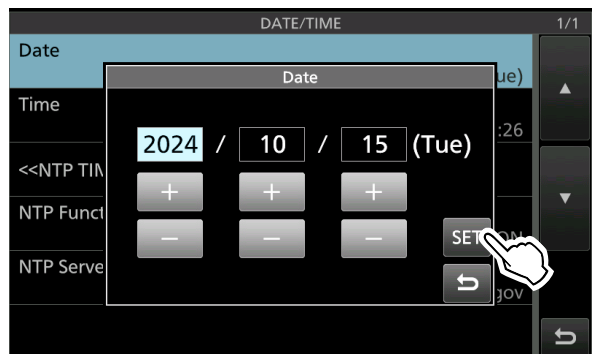

- Returns to the previous screen.
- ① To cancel the editing, touch **ESC**.

KEYBOARD ENTERING AND EDITING

Keyboard types:

You can select the Full Keyboard or the Tenkey pad in "Screen Keyboard Type" on the FUNCTION screen.

(p. 8-7)

MENU » **SET > Function > Screen Keyboard Type**

① You can also temporarily switch the type in the QUICK MENU screen by pushing **QUICK**.

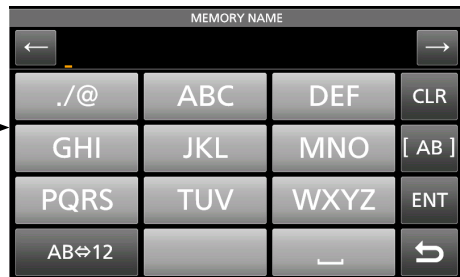
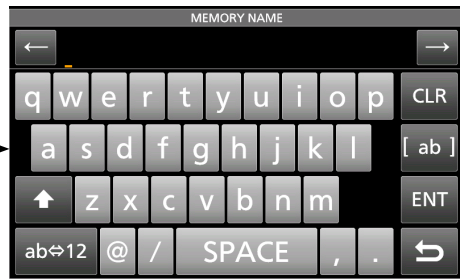
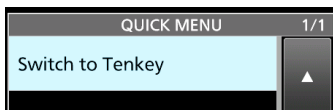
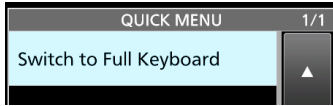

① You can select the full keyboard layout in "Screen Full Keyboard Layout" on the FUNCTION screen. (p. 8-7)

MENU » **SET > Function > Screen Full Keyboard Layout**

Entering and editing:

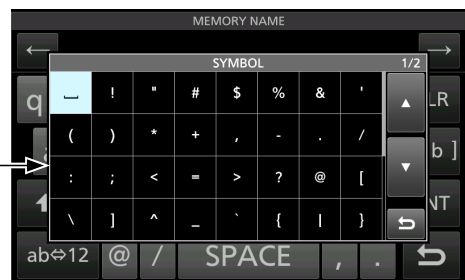
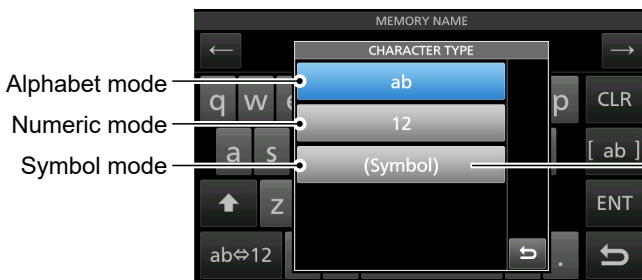
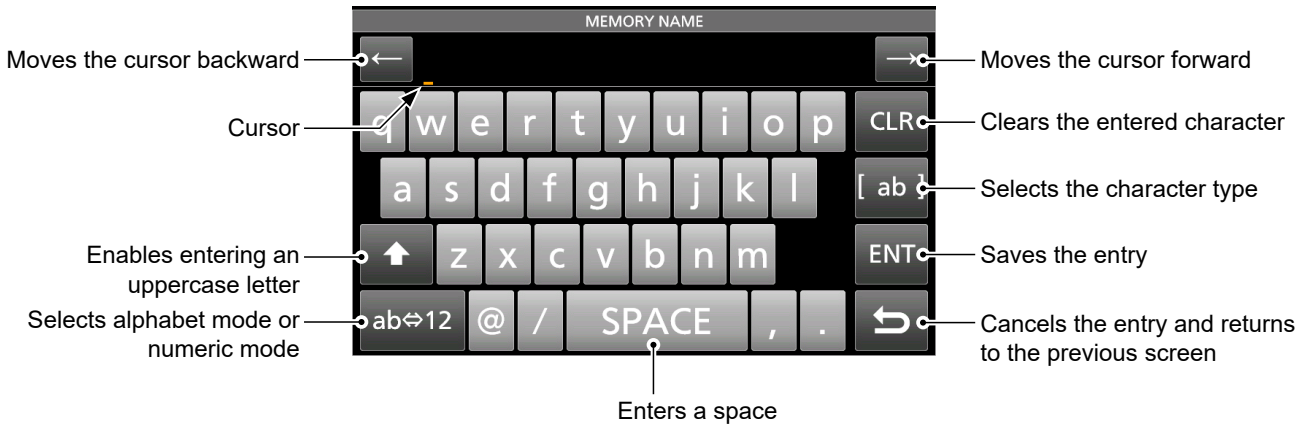

USABLE CHARACTERS

You can enter and edit the items in the following table.

Menu	Item	Selectable characters	Maximum characters
SET	Network Name	A to Z, 0 to 9, ! " # \$ % & () + , - . ; = @ [] ^	15
	Network User 1/2 ID	[AB] [ab] [12] [!"#]	16
	Network User 1/2 Password	• Illegal characters: \ (space)	16*
	Network Radio Name		16
	My Call	A to Z, 0 to 9, / @ - .	10
	NTP Server Address	A to Z, a to z, 0 to 9, - .	64
	CLOCK2 NAME	[AB] [ab] [12] [!"#]	3
	Save Setting	[AB] [ab] [12] [!"#] • Illegal characters: / : ; * < > \	23
SCAN	NAME	[AB] [ab] [12] [!"#]	16
KEYER	Keyer Memory	A to Z, 0 to 9, (space), / ? ^ . , @ • "*" (asterisk) has its own unique use.	70
DECODE	RTTY Memory	A to Z, 0 to 9, (space), ! \$ & ? " ' - / . , ; ; () ↵ • "*" (asterisk) has its own unique use.	70
	PSK Memory	[AB] [ab] [12] [!"#]	70
VOICE	VOICE TX RECORD	[AB] [ab] [12] [!"#]	16
MEMORY	MEMORY NAME	[AB] [ab] [12] [!"#]	10
PRESET	Preset Name	[AB] [ab] [12] [!"#]	16

[AB]: A to Z, (space)

[ab]: a to z, (space)

[12]: 0 to 9, (space)

[!"#]: ! " # \$ % & ' () * + , - . / : ; < = > ? @ [\] ^ _ ` { | } ~ (space)

* Minimum of 8 characters

TABLE OF CONTENTS

IMPORTANT.....	i	Selecting the Main and Sub bands.....	3-2
FEATURES.....	i	◇ Switching the Main band and Sub band.....	3-2
SUPPLIED ACCESSORIES.....	i	Dualwatch operation.....	3-2
TRADEMARKS.....	i	Selecting the operating band.....	3-3
EXPLICIT DEFINITIONS.....	ii	◇ Selecting the operating band	
DISPOSAL.....	ii	on the Sub screen.....	3-3
ABOUT CE AND DOC.....	ii	◇ Selecting the operating band	
ABOUT UKCA DOC.....	ii	on the Main screen.....	3-3
FCC INFORMATION.....	ii	Selecting the operating mode.....	3-4
ABOUT SPURIOUS SIGNALS.....	iii	Setting the frequency.....	3-5
ABOUT THE TOUCH SCREEN.....	iii	◇ Using the Main Dial.....	3-5
◇ Touch operation.....	iii	◇ About the Tuning Step function.....	3-5
◇ Touch screen precautions.....	iii	◇ Changing the Tuning Step.....	3-5
◇ Touch screen maintenance.....	iii	◇ About the 1 Hz step Fine Tuning function.....	3-5
ABOUT THE MANUALS.....	iii	◇ About the 1/4 Tuning function.....	3-5
ABOUT THE INSTRUCTIONS.....	iv	◇ About the Auto Tuning Step function.....	3-5
KEYBOARD ENTERING AND EDITING.....	v	◇ Directly entering a frequency.....	3-6
USABLE CHARACTERS.....	vi	RF gain and SQL level.....	3-8
PRECAUTIONS.....	ix	Selecting the antenna connector.....	3-9
INSTALLATION NOTES.....	x	Dial Lock function.....	3-9
1 PANEL DESCRIPTION.....	1-1	Basic transmission.....	3-9
Front panel (Controller/RF deck).....	1-1	Adjusting the microphone gain.....	3-9
Rear panel (Controller).....	1-3	Adjusting the transmit output power.....	3-10
Rear panel (RF deck).....	1-4	Transmit Power Limit function.....	3-10
Touch screen display (Main screen).....	1-5	Meter display on the Main screen.....	3-11
◇ MENU screen.....	1-7	◇ Selecting the Meter display.....	3-11
◇ QUICK MENU.....	1-7	◇ Selecting the Meter type.....	3-11
◇ FUNCTION screen.....	1-7	◇ Multi-function meter.....	3-11
◇ Multi-function menus.....	1-8	4 RECEIVING AND TRANSMITTING.....	4-1
◇ Multi-function key group.....	1-8	Preamplifiers.....	4-1
Multi-function dial.....	1-9	Attenuator.....	4-1
Touch screen display (Sub screen).....	1-10	RIT function.....	4-1
◇ Filter Effect screen.....	1-10	◇ RIT monitor function.....	4-1
◇ Keypad screen.....	1-10	AGC function control.....	4-2
◇ Meter screen.....	1-10	◇ Selecting the AGC time constant	
2 INSTALLATION AND CONNECTIONS.....	2-1	preset value.....	4-2
Selecting a location.....	2-1	◇ Setting the AGC time constant.....	4-2
Attaching the desktop stand.....	2-1	Setting the Speech Compressor.....	4-3
Before using the transceiver.....	2-1	◇ Setting before using the Speech	
Heat dissipation.....	2-1	Compressor function.....	4-3
Grounding.....	2-1	◇ Using the Speech Compressor function.....	4-3
Connecting the controller and RF deck.....	2-2	Using the Digital Twin PBT.....	4-4
Connecting the AH-730.....	2-2	◇ Using the Filter Effect screen.....	4-4
Connecting a linear amplifier.....	2-3	Selecting the IF filter.....	4-5
◇ Connecting the IC-PW2.....	2-3	Selecting the IF filter shape.....	4-5
◇ Connecting a non-Icom linear amplifier.....	2-4	Notch Filter.....	4-6
Connecting a Transverter.....	2-4	◇ Selecting the Notch filter type.....	4-6
3 BASIC OPERATION.....	3-1	◇ Setting the Manual Notch filter.....	4-6
When first applying power.....	3-1	◇ Using the Filter Effect screen.....	4-6
Turning power ON or OFF.....	3-1	Noise Blanker.....	4-7
◇ Turning ON the RF deck.....	3-1	◇ Adjusting the NB level and time.....	4-7
◇ Turning ON the controller.....	3-1	Noise Reduction.....	4-7
Adjusting the volume level.....	3-1	◇ Adjusting the Noise Reduction level.....	4-7
Selecting the mode.....	3-1	Setting the transmit filter width.....	4-8
		Monitor function.....	4-8

DPD function	4-9	USB Flash Drive	8-18
◇ Turning the DPD function ON or OFF	4-9	Others	8-18
Digital Selector	4-9	9 CLOCK..... 9-1	
◇ Adjusting the center frequency	4-9	Setting the date and time	9-1
Split frequency operation	4-10	◇ Setting the date	9-1
◇ Using the Quick Split function	4-10	◇ Setting the current time	9-1
◇ Using the receive and transmit frequencies set to Main and Sub bands	4-10	◇ Setting the UTC offset	9-1
Split Lock function	4-11	◇ Displaying CLOCK2	9-1
Auto Tuning function	4-11	◇ Setting the CLOCK2 UTC offset	9-2
Operating CW	4-11	◇ Editing the CLOCK2 name	9-2
◇ Setting the CW pitch control	4-11	10 MAINTENANCE 10-1	
◇ Setting the key speed	4-11	Cleaning	10-1
◇ Using the Break-in function	4-12	Resetting	10-1
◇ Monitoring the CW side tone	4-12	◇ Partial reset	10-1
◇ Audio Peak Filter (APF) operation	4-13	◇ All reset	10-1
◇ About the electronic Keyer function	4-13	Troubleshooting	10-2
5 SCOPE OPERATION..... 5-1		11 SPECIFICATIONS 11-1	
Spectrum scope screen	5-1	◇ General	11-1
◇ Using the Spectrum Scope	5-1	◇ Transmitter	11-1
◇ Marker	5-2	◇ Receiver	11-2
◇ Mini scope screen	5-2	◇ Antenna tuner	11-2
Audio scope screen	5-2	12 OPTIONS 12-1	
◇ Using the Audio Scope	5-2	Options	12-1
6 SD CARD/USB FLASH DRIVE 6-1		13 CONNECTOR INFORMATION 13-1	
About the SD cards	6-1	RF Deck	13-1
About the USB flash drive	6-1	◇ ACC sockets	13-1
Saving data	6-1	◇ [ANT 1]/[ANT 2]/[ANT 3]/[ANT 4]	13-2
Inserting	6-1	◇ [X-VERTER]	13-2
Formatting	6-2	◇ [REF IN]	13-2
Unmounting	6-2	◇ [RX-ANT IN]/[RX-ANT OUT]	13-2
7 ANTENNA TUNER OPERATION 7-1		◇ [REMOTE]	13-2
About the Antenna memory settings	7-1	◇ [TUNER]	13-3
◇ The Antenna memory screen	7-1	◇ [CONTROLLER]	13-3
◇ Saving an antenna connector setting	7-1	◇ [LAN]	13-3
◇ Setting the antenna type	7-2	◇ [KEY]	13-3
About the internal antenna tuner	7-3	◇ [ALC]	13-3
◇ Using the Internal antenna tuner	7-3	◇ [SEND]	13-3
◇ Manual tuning	7-3	◇ [USB] (for I/Q output)	13-3
◇ PTT Tuner start	7-3	◇ [AC]	13-3
About the external antenna tuner	7-4	Controller	13-4
◇ Using the AH-730	7-4	◇ [MIC]	13-4
◇ Using the IC-PW2	7-4	◇ [PHONES]	13-4
◇ Using an external antenna tuner	7-4	◇ [RF DECK]	13-4
8 SET MODE..... 8-1		◇ [EXT-DISPLAY]	13-4
Set mode description	8-1	◇ [USB A]	13-5
Tone Control/TBW	8-2	◇ [USB B]	13-5
CW-KEY Set	8-2	◇ [EXT-KEYPAD]	13-5
Function	8-3	◇ [ELEC-KEY]	13-5
DPD Adjustment	8-9	◇ [SEND]	13-6
Connectors	8-9	◇ [LINE IN]/[LINE OUT]	13-6
Network	8-14	◇ [EXT-SP A]/[EXT-SP B]	13-7
Display	8-16	◇ [DC IN]	13-7
Time Set	8-17	INDEX	I
SD Card	8-17	ABOUT THE LICENSES	II

PRECAUTIONS

⚠ **DANGER HIGH RF VOLTAGE! NEVER** touch an antenna, an antenna connector, or a ground terminal while transmitting. This could cause an electrical shock or burn.

⚠ **DANGER! NEVER** operate the transceiver near unshielded electrical blasting caps or in an explosive atmosphere. This could cause an explosion and death.

⚠ **WARNING RF EXPOSURE!** This transceiver emits Radio Frequency (RF) energy. Extreme caution should be observed when operating this transceiver. If you have any questions regarding RF exposure and safety standards please refer to the Federal Communications Commission Office of Engineering and Technology's report on Evaluating Compliance with FCC Guidelines for Human Radio Frequency Electromagnetic Fields (OET Bulletin 65).

⚠ **WARNING! NEVER** operate the transceiver with earphone, a headset, or other audio accessories at high volume levels. If you experience a ringing in your ears, reduce the volume or discontinue use.

⚠ **WARNING! NEVER** let metal, wire or other objects contact the inside of the transceiver, or make incorrect contact with connectors. This could cause an electric shock or damage the transceiver.

⚠ **WARNING! NEVER** operate or touch the transceiver with wet hands. This could cause an electric shock or damage to the transceiver.

⚠ **WARNING! NEVER** operate the equipment if you notice an abnormal odor, sound or smoke. Immediately turn OFF the power and/or remove the power cables. Contact your Icom dealer or distributor for advice.

⚠ **WARNING! NEVER** put the transceiver on an unstable place where the transceiver may suddenly move or fall. This could cause an injury or damage the transceiver.

⚠ **WARNING! NEVER** operate the transceiver during a lightning storm. It may result in an electric shock, cause a fire or damage the transceiver. Always disconnect the power cables and antenna before a storm.

CAUTION: DO NOT expose the transceiver to rain, snow or any liquids. They could damage the transceiver.

CAUTION: DO NOT operate the transceiver unless the antenna and cables are securely attached to the transceiver, and that the antenna and cables are dry before attachment. Exposing the inside of the transceiver to dust or water will result in serious damage to the transceiver.

CAUTION: DO NOT change the internal settings of the transceiver. This could reduce transceiver performance and/or damage to the transceiver. The transceiver warranty does not cover any problems caused by unauthorized internal adjustments.

CAUTION: DO NOT install or place the transceiver in a place without adequate ventilation, or block any cooling vents on the top, rear, sides or bottom of the transceiver or the cooling fan. Heat dissipation may be reduced and damage the transceiver.

CAUTION: DO NOT use harsh solvents such as Benzine or alcohol when cleaning. This could damage the transceiver surfaces. If the surface becomes dusty or dirty, wipe it clean with a soft, dry cloth.

CAUTION: DO NOT use or leave the transceiver in areas with temperatures below 0°C (32°F) or above 50°C (122°F).

CAUTION: DO NOT place the transceiver in excessively dusty environments. This could damage the transceiver.

CAUTION: DO NOT set the transceiver's RF output power to more than a connected linear amplifier's maximum input level. Otherwise, the linear amplifier will be damaged.

CAUTION: DO NOT use non-Icom microphones. Other microphones have different pin assignments, and may damage the transceiver.

CAUTION: The RF deck weighs approximately 15.8 kg (35 lb). Always have 2 people carry, lift or turn over the RF deck.

DO NOT push PTT unless you actually intend to transmit.

NEVER leave the transceiver in an insecure place to avoid use by unauthorized persons.

Turn OFF the transceiver's power and disconnect the power cables from the AC outlet when you will not use the transceiver for long period of time.

The LCD display may have cosmetic imperfections that appear as small dark or light spots. This is not a malfunction or defect, but a normal characteristic of LCD displays.

Operate the transceiver that complies with your local laws and regulations.

Depending on countries and/or regions, transceiver's output power and/or operations on specific frequencies may be restricted to avoid interferences with existing radio stations or services.

INSTALLATION NOTES

For amateur base station installations it is recommended that the forward clearance in front of the antenna array is calculated relative to the EIRP (Effective Isotropic Radiated Power). The clearance height below the antenna array can be determined in most cases from the RF power at the antenna input terminals.

As different exposure limits have been recommended for different frequencies, a relative table shows a guideline for installation considerations.

Below 30 MHz, the recommended limits are specified in terms of V/m or A/m fields as they are likely to fall within the near-field region. Similarly, the antennas may be physically short in terms of electrical length and that the installation will require some antenna matching device which can create local, high intensity magnetic fields. Analysis of such MF installations is best considered in association with published guidance notes such as the FCC OET Bulletin 65 Edition 97-01 and its annexes relative to amateur transmitter installations. The EC recommended limits are almost identical to the FCC specified 'uncontrolled' limits and tables exist that show pre-calculated safe distances for different antenna types for different frequency bands. Further information can be found at <http://www.arrl.org/>.

• Typical amateur radio installation

Exposure distance assumes that the predominant radiation pattern is forward and that radiation vertically downwards is at unity gain (sidelobe suppression is equal to main lobe gain). This is true of almost every gain antenna today. Exposed persons are assumed to be beneath the antenna array and have a typical height of 1.8 m.

The figures assume the worst case emission of a constant carrier.

For the bands 10 MHz and higher the following power density limits have been recommended:

10–50 MHz 2 W/sq m

Vertical clearance by EIRP output

1 Watts	2.1 m
10 Watts	2.8 m
25 Watts	3.4 m
100 Watts	5 m
1000 Watts	12 m

Forward clearance by EIRP output

100 Watts	2 m
1000 Watts	6.5 m
10,000 Watts	20 m
100,000 Watts	65 m

In all cases any possible risk depends on the transmitter being activated for long periods. (actual recommendation limits are specified as an average during 6 minutes)

Normally the transmitter is not active for long periods of time. Some radio licenses will require that a timer circuit automatically cuts the transmitter after 1–2 minutes etc.

Similarly some types of emission, i.e., SSB, CW, AM etc. have a lower 'average' output power and the assessed risk is even lower.

Front panel (Controller/RF deck)

Controller

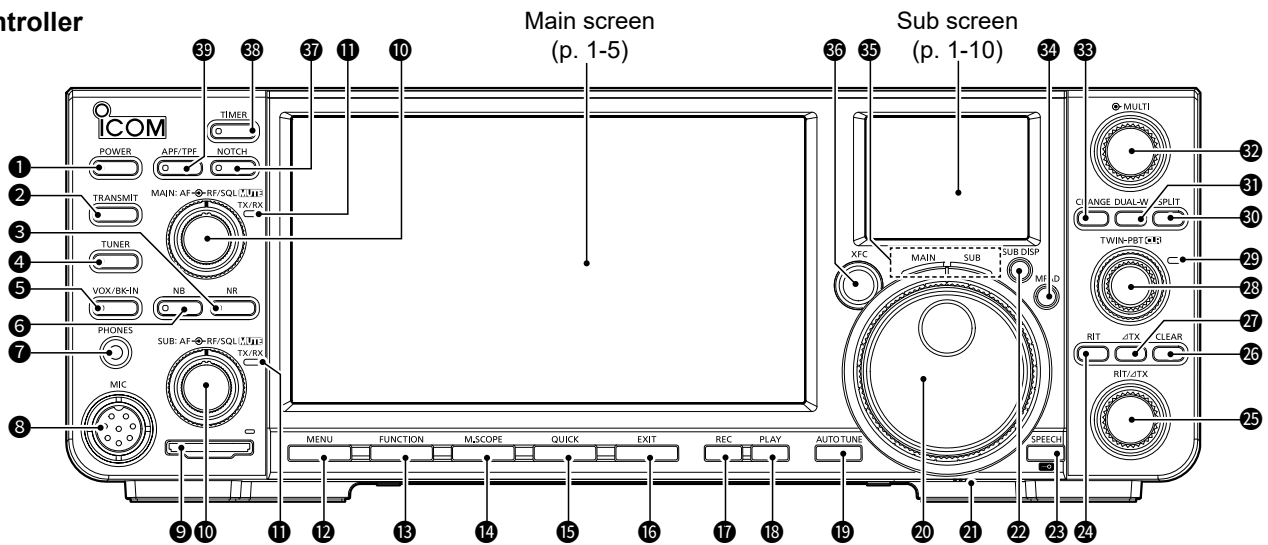

- 1 POWER KEY** **POWER** (p. 3-1)
- Push to turn ON the controller.
 - Hold down for 1 second to turn OFF the controller.
- 2 TRANSMIT KEY** **TRANSMIT** (p. 3-9)
- Push to toggle between transmit and receive.
- 3 NOISE REDUCTION KEY** **NR** (p. 4-7)
- Push to turn the Noise Reduction function ON or OFF.
- 4 ANTENNA TUNER KEY** **TUNER** (pp. 7-3, 7-4)
- Push to turn the antenna tuner ON or OFF, or activate the tuner.
- 5 VOX/BREAK-IN KEY** **VOX/BK-IN**
- Push to turn the VOX function and the Break-in function in the CW mode (p. 4-12) ON or OFF.
- 6 NOISE BLANKER KEY** **NB** (p. 4-7)
- Push to turn the Noise Blanker function ON or OFF.
- 7 HEADPHONE JACK [PHONES]** (p. 13-4)
- Connect standard stereo headphones.
- 8 MICROPHONE CONNECTOR [MIC]** (p. 13-4)
- Connect a microphone (user supplied).
- 9 SD CARD SLOT [SD CARD]** (p. 6-1)
- Insert an SD card (user supplied).
- The indicator lights while an SD card is inserted, and blinks while accessing the card.
- 10 VOLUME CONTROL/MUTE KEY** **AF** / **RF/SQL** / **MUTE**
- ① The upper control is for the Main band, and the lower is for the Sub band.
- Rotate to adjust the audio output level. (p. 3-1)
 - Push to turn the Mute function ON or OFF.
 - The TX/RX indicator lights orange when the Mute function is ON.
- RF GAIN/SQUELCH CONTROL** **AF** / **RF/SQL** (p. 3-8)
- Rotate to adjust the RF gain and squelch threshold levels.
- 11 TX/RX INDICATOR**
- ① The upper indicator is for the Main band, and the lower is for the Sub band.
- Lights red while transmitting.
 - Lights green while receiving.
- 12 MENU KEY** **MENU** (pp. 1-7, 8-1)
- Push to open the MENU screen.
- 13 FUNCTION KEY** **FUNCTION** (p. 1-7)
- Push to open the FUNCTION screen.
- 14 MINI SCOPE KEY** **M.SCOPE** (p. 5-2)
- Push to display the Mini scope screen.
 - Hold down for 1 second to display the Spectrum scope screen.
- 15 QUICK KEY** **QUICK** (p. 1-7)
- Push to open the QUICK MENU screen.
- 16 EXIT KEY** **EXIT**
- Push to exit a setting screen or return to the previous screen.

Front panel (Controller/RF deck)

- 17 VOICE MEMORY RECORD KEY** **REC**
 - Push to save the previously received signal for the preset time period set in REC Time using the Instant Replay function.
 - Hold down for 1 second to start recording a QSO audio onto an SD card.
- 18 VOICE MEMORY PLAY BACK KEY** **PLAY**
 - Push to play back the last 5 seconds of the Instant Replay memory.
 - Hold down to play back all of the Instant Replay memory.
- 19 AUTO TUNE KEY** **AUTO TUNE** (p. 4-11)
In the AM or CW mode, push to automatically tune the operating frequency to a close-by signal.
- 20 MAIN DIAL** **MAIN DIAL**
Rotate to change the operating frequency.
- 21 FRICTION ADJUSTER**
Slide to adjust the friction of **MAIN DIAL**.
- 22 SUB DISPLAY KEY** **SUB DISP** (p. 1-10)
Push to change the information displayed on the Sub screen.
- 23 SPEECH/LOCK KEY** **SPEECH** 
 - Push to announce the operating frequency or mode.
 - Hold down for 1 second to electronically lock **MAIN DIAL**. (p. 3-9)
- 24 RIT KEY** **RIT** (p. 4-1)
Push to turn the Receiver Incremental Tuning (RIT) function ON or OFF.
- 25 RIT/ Δ TX CONTROL** **RIT/ Δ TX**
Rotate to shift the receive or transmit frequency up to ± 9.99 kHz without changing the transmit or receive frequency.
- 26 CLEAR KEY** **CLEAR**
Push to clear the RIT or Δ TX shift frequency.
- 27 Δ TX KEY** **Δ TX**
Push to turn the Δ TX function ON or OFF.
- 28 TWIN PASSBAND TUNING CONTROL** **TWIN PBT CLR** (p. 4-4)
 - Rotate to adjust the IF filter's passband width.
 - Hold down for 1 second to clear the PBT settings.
- 29 TWIN PBT INDICATOR** (p. 4-4)
Lights white when you change the IF passband width.
- 30 SPLIT KEY** **SPLIT** (p. 4-10)
Push to turn the Split function ON or OFF.
- 31 DUALWATCH KEY** **DUAL-W** (p. 3-2)
Push to turn the Dualwatch function ON or OFF.

- 32 MULTI-FUNCTION CONTROL** **MULTI**
 - Push to open the Multi-function menu for various adjustments. (p. 1-8)
 - Rotate to adjust the value that is assigned to **MULTI**. (p. 1-9)
- 33 MAIN/SUB CHANGE KEY** **CHANGE** (p. 3-2)
Push to toggle the frequency, mode, and selected memory channel between the Main and Sub band.
- 34 MEMO PAD KEY** **MPAD**
 - Push to sequentially call up the contents in the Memo Pads.
 - Hold down for 1 second to save the displayed contents into the Memo Pad.
- 35 MAIN/SUB INDICATOR** (p. 3-2)
The indicator of the selected band lights white.
- 36 TRANSMIT FREQUENCY CHECK KEY** **XFC**
 - Hold down to temporarily open the squelch and cancel the noise reduction and RIT function.
 - While the Split or Δ TX function is ON, or using a repeater, hold down to monitor the transmit frequency.
- 37 NOTCH KEY** **NOTCH** (p. 4-6)
Push to select the Notch function type.
- 38 TIMER KEY** **TIMER**
Push to turn the Sleep Timer or Daily Timer function ON or OFF.
- 39 AUDIO PEAK FILTER/TWIN PEAK FILTER KEY** **APF/TPF**
 - In the CW mode, push to turn the Audio Peak Filter ON or OFF. (p. 4-13)
 - In the RTTY mode, push to turn the Twin Peak Filter ON or OFF.

RF deck

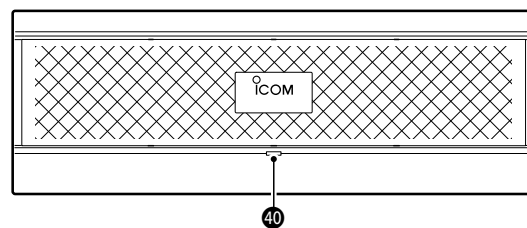

- 40 POWER INDICATOR**
 - Lights orange while the internal power supply is ON and in the standby mode.
 - Lights blue while the RF deck is working.

Rear panel (Controller)

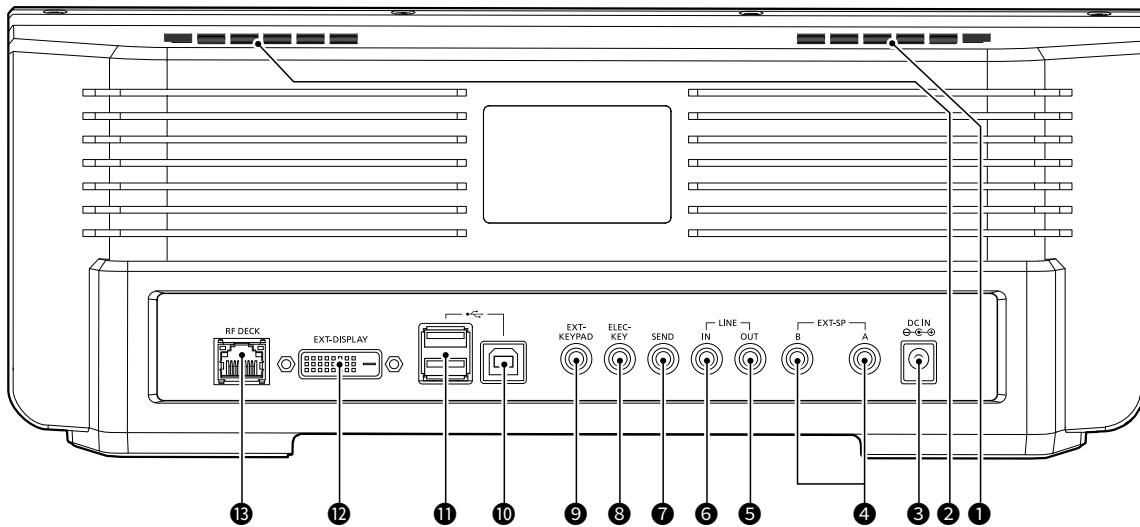

1 INTERNAL SPEAKER L (p. 13-7)

Outputs the audio from the Main band.
 ① When "Speaker MAIN/SUB Mix" is set to "ON," outputs the audio from both Main and Sub bands.

2 INTERNAL SPEAKER R (p. 13-7)

- When Dualwatch is OFF, outputs the audio from the Main band.
 - When Dualwatch is ON, outputs the audio from the Sub band.
- ① When "Speaker MAIN/SUB Mix" is set to "ON," outputs the audio from both Main and Sub band.

3 DC POWER JACK [DC IN] (p. 2-2)

Connect the supplied power adapter to an AC receptacle.

4 EXTERNAL SPEAKER JACK [EXT-SP A]/[EXT-SP B] (p. 13-7)

Connect a 4 ~ 8 Ω external speaker with a 3.5 mm (1/8 inch) stereo plug.

5 LINE OUT JACK [LINE OUT] (p. 13-6)

Outputs the demodulated AF signal or 12 kHz IF signal.

6 LINE IN JACK [LINE IN] (p. 13-6)

Input the audio signal to the internal modulator circuit.

7 SEND JACK [SEND] (p. 13-6)

Connect to control transmit with non-Icom external units.

8 KEY JACK [ELEC-KEY] (p. 13-5)

Connect to a CW paddle with a 3.5 mm (1/8 inch) stereo plug.

9 EXTERNAL KEYPAD JACK [EXT-KEYPAD] (p. 13-5)

Connect to an external keypad for direct Voice Memory, Keyer Memory, RTTY Memory, or PSK Memory transmission.

10 USB PORT (TYPE-B) [USB B] (p. 13-5)

Connect to a PC.

11 USB PORT (TYPE-A) [USB A] (p. 13-5)

Insert a USB flash drive, or connect a keyboard, mouse, RC-28 REMOTE ENCODER, or hub.

12 EXTERNAL DISPLAY CONNECTOR [EXT-DISPLAY] (p. 13-4)

Connect to an external display monitor.

13 RF DECK CONNECTOR [RF DECK] (p. 2-2)

- Connect to the RF deck with the supplied control cable or through a LAN.
- ① When connecting the controller and RF deck directly, operation cannot be guaranteed if you use other than the specified cable or a network switch.
 - ① Confirm the Network settings before connect to a network.

NOTE: Confirm that the transceiver is OFF before connecting or disconnecting optional equipment.

Rear panel (RF deck)

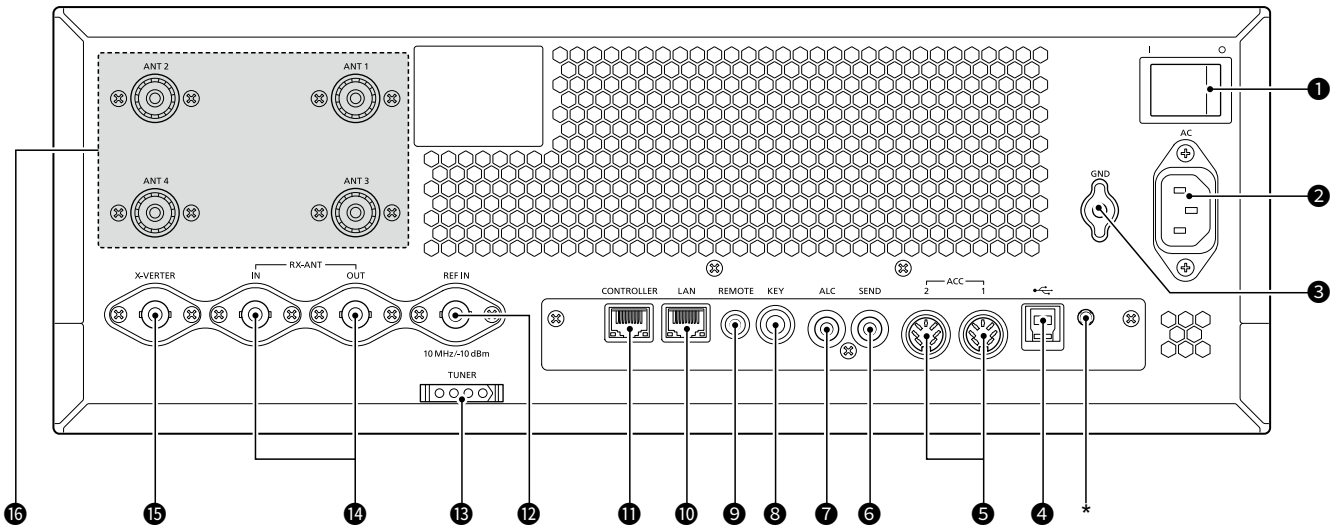

* The switch is not used.

- 1 MAIN POWER SUPPLY SWITCH [I/O] (p. 3-1)**
Toggle to turn the internal power supply ON or OFF.
- 2 AC POWER SOCKET [AC] (p. 2-2)**
Connect the supplied power cable to an AC receptacle.
- 3 GROUND TERMINAL [GND] (p. 2-1)**
Connect to ground to prevent electrical shocks, TVI, BCI, and other problems.
- 4 USB PORT (TYPE-B) [USB] (p. 13-3)**
For digital data input or output.
- 5 ACC SOCKET [ACC 1]/[ACC 2] (p. 13-1)**
Connect to devices to control an external unit or to control the transceiver.
- 6 SEND JACK [SEND] (p. 13-3)**
Connect to control transmit with non-Icom external units.
- 7 ALC JACK [ALC] (p. 13-3)**
Connect to the ALC output jack of a non-Icom linear amplifier.
- 8 STRAIGHT KEY JACK [KEY] (p. 13-3)**
Connect to a straight key or external electronic keyer with a 6.35 mm (1/4 inch) standard plug.
- 9 REMOTE CONTROL JACK [REMOTE] (p. 13-2)**
Connect to a PC or other transceiver for remote control.
- 10 ETHERNET CONNECTOR [LAN] (p. 13-3)**
Connect to a PC network through a LAN.
① Confirm the Network settings before connecting to a network.
- 11 CONTROLLER CONNECTOR [CONTROLLER] (p. 2-2)**
Connect to the controller with the supplied control cable.
① Operation cannot be guaranteed if you use other than the specified cable or a network switch.
- 12 REFERENCE SIGNAL INPUT [REF IN] (p. 13-2)**
Input for a 10 MHz reference signal through the BNC connector.
- 13 TUNER CONTROL SOCKET [TUNER] (pp. 2-2, 13-3)**
Accepts the control cable from an optional AH-730 AUTOMATIC ANTENNA TUNER.
- 14 RECEIVE ANTENNA [RX-ANT IN]/[RX-ANT OUT] (p. 13-2)**
Connect to an external unit, such as preamplifier or RF filter, using BNC connectors.
① This is located between the transmit/receive switching circuit and receiver's RF stage.
- 15 TRANSVERTER CONNECTOR [X-VERTER] (pp. 2-4, 13-2)**
Connect to an external transverter for input/output.
- 16 ANTENNA CONNECTOR [ANT 1] ~ [ANT 4] (p. 13-2)**
Connect a 50 Ω antenna.

Touch screen display (Main screen)

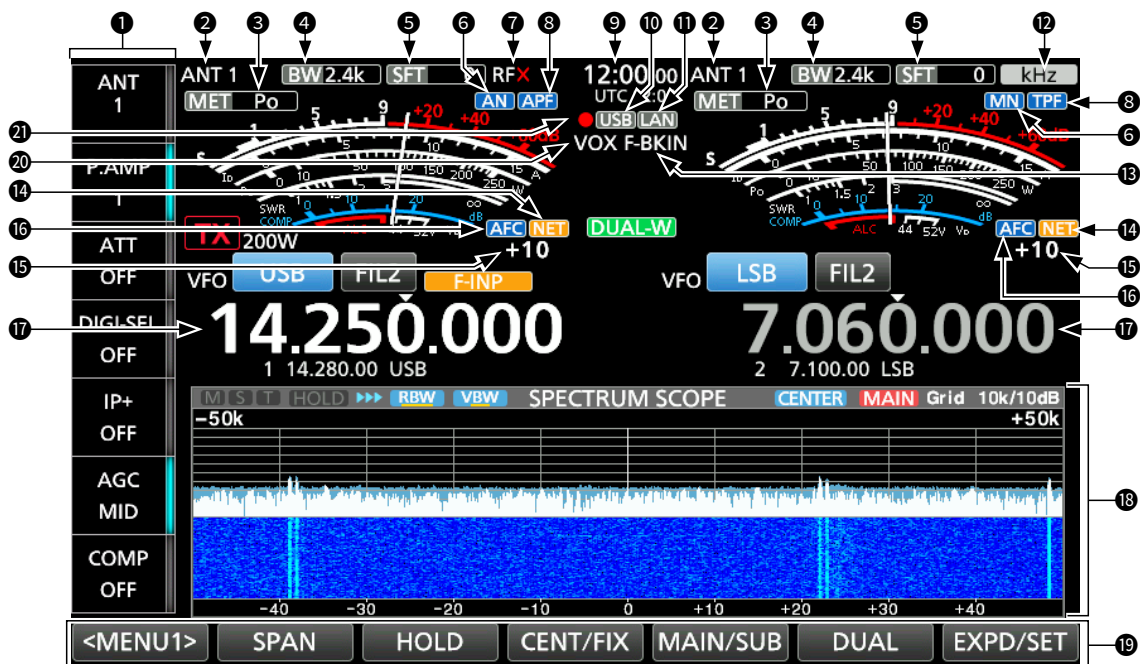

1 MULTI-FUNCTION KEY GROUP (p. 1-8)

Displays the Multi-function keys.
 ① Touch to turn the function ON or OFF.

2 ANTENNA INDICATOR (pp. 3-9, 7-1)

Displays the selected antenna connector between ANT 1, ANT 2, ANT 3, and ANT 4.

3 METER TYPE INDICATOR (p. 3-11)

Displays the selected transmit parameter type between Po, SWR, ALC, COMP, V_D, and ID.

4 BANDWIDTH INDICATOR (pp. 4-4, 4-5)

Displays the passband width of the IF filter.

5 SHIFT VALUE INDICATOR (p. 4-4)

Displays the shift value of the IF filter.

6 NOTCH INDICATOR (p. 4-6)

Displayed when the Auto Notch (AN) or Manual Notch (MN) function is ON.

7 CONNECTION ERROR INDICATOR

Blinks while the RF deck is not connected to the controller.

8 AUDIO PEAK FILTER/TWIN PEAK FILTER INDICATORS

Displayed when the Audio Peak Filter (APF, p. 4-13) or Twin Peak Filter (TPF) is ON.

9 CLOCK READOUT (p. 9-1)

Displays the time (2 types) set on the TIME SET screen.

10 USB INDICATOR (p. 6-1)

Displayed while a USB flash drive is inserted.

11 NETWORK CONTROL ICON

Displayed while accessing the transceiver using the optional RS-BA1, for Remote control operation.

12 FUNCTION INDICATOR FOR MULTI-FUNCTION CONTROL (p. 1-9)

Displays the function that is assigned to **(MULTI)**.

13 BK-IN/F-BKIN INDICATORS (p. 4-12)

Displayed when the Semi Break-in (BK-IN) or Full Break-in (F-BKIN) function is ON.

14 NET FUNCTION INDICATOR

Displayed when the NET function is ON in the PSK mode.

15 FREQUENCY OFFSET READOUT/TONE SQUELCH ICON

- Displays the offset value between the PSK signal and the operating frequency, while a PSK signal is received.
- Displays "TONE" or "TSQL" when the tone squelch function is ON in the FM mode.

16 AFC ICON

Displayed while the Auto Frequency Control (AFC) function is ON in the PSK mode.

17 FREQUENCY READOUT (p. 3-2)

Displays the operating frequency.
 ① The non-selected band's frequency readout (Main or Sub) is displayed in gray.

18 FUNCTION DISPLAY

Displayed when an item that has a function display is selected. (Example: Spectrum Scope)

19 FUNCTION KEYS

Displays the function keys.
 ① Touch to operate the function display (18).

20 VOX INDICATORS

Displayed when the VOX function is ON.

21 VOICE RECORDER ICONS ●/||

Displayed while recording or pausing using the Voice recorder.

Touch screen display (Main screen)

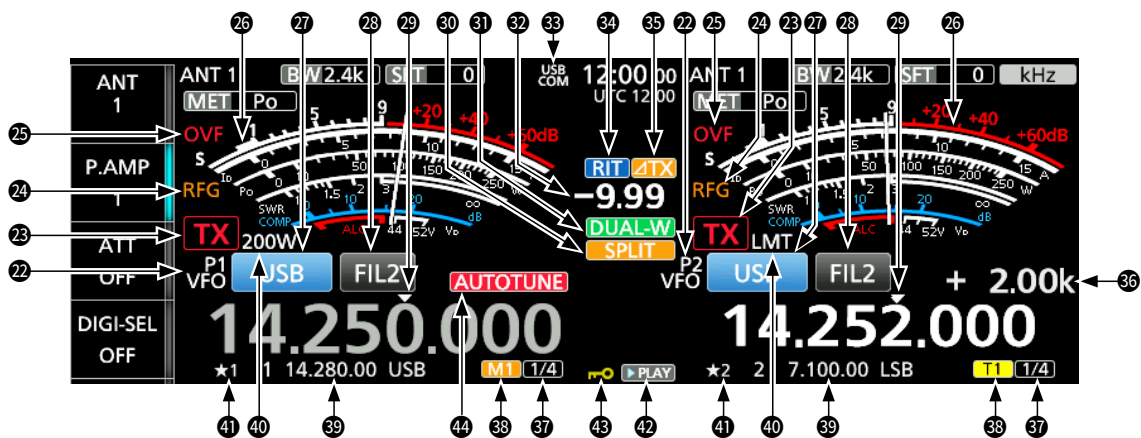

- 22 VFO/MEMORY ICONS (p. 3-1)**
 Displays “VFO” when the VFO mode is selected, and displays the selected memory channel number when the Memory mode is selected.
- 23 TX STATUS INDICATOR**
 Displays the transmit status.

 - **TX** is displayed on the band used for transmit.
 - **TX** is displayed while transmitting.
 - **TX** (with a dotted line) is displayed when the selected frequency is outside of the band edge frequency range.
 - **TX** (Grayed out) is displayed when transmission is inhibited.
- 24 RF GAIN ICON (p. 3-8)**
 Displayed when **RF/SQL** (outer) is set counterclockwise from the 11 o'clock position to decrease the RF gain.
- 25 OVF ICON (p. 3-8)**
 Displayed when an excessively strong signal is received.
- 26 METER INDICATOR (p. 3-11)**
 Displays the S, Id, Po, SWR, COMP, ALC, and Vd meters.
- 27 MODE INDICATOR (p. 3-4)**
 Displays the selected operating mode.
- 28 IF FILTER INDICATOR (pp. 4-4, 4-5)**
 Displays the selected IF filter number.
 ① A dot “.” is displayed on the IF Filter Indicator when you change the IF passband width.
- 29 QUICK TUNING ICON (p. 3-5)**
 Displayed when the Quick Tuning Step function is ON.
- 30 SPLIT ICON (p. 4-10)**
 Displayed when the Split function is ON.
- 31 DUALWATCH ICON (p. 3-2)**
 Displayed when the Dualwatch function is ON.
- 32 RIT/ Δ TX FREQUENCY READOUT**
 Displays the shift offset frequency for the RIT or Δ TX functions.
- 33 USB CONNECTION INDICATOR (p. 13-5)**
 Displayed when an external USB Host device, such as a PC, is connected to [USB B] on the controller.
- 34 RIT ICON (p. 4-1)**
 Displayed when the Receive Increment Tuning (RIT) function is ON.
- 35 Δ TX ICON**
 Displayed when the Δ TX function is ON.
- 36 FREQUENCY OFFSET READOUT**
 Displays the frequency offset between transmit and receive when the split function is ON and monitoring the transmit frequency.
- 37 1/4 ICON (p. 3-5)**
 Displayed while the 1/4 Tuning function is ON.
- 38 M1~M8/T1~T8 ICONS**

 - “M1” ~ “M8” is displayed while the Keyer memory transmission using an external keypad or keyboard is enabled, and transmitting the memory contents.
 - “T1” ~ “T8” is displayed while the Voice TX memory transmission using an external keypad or keyboard is enabled, and transmitting the Voice TX memory contents.
- 39 MEMORY CHANNEL/VFO READOUT (p. 3-1)**
 Displays the selected memory channel contents in the VFO mode, and displays the VFO contents in the Memory mode.
- 40 RF POWER INDICATOR/LMT ICON/INH ICON**
 Displays the transmit output power. (p. 3-10)
 ① “LMT” is displayed if the power amplifier temperature becomes extremely high, and the Protection function is activated after transmitting continuously for a long period of time.
 ① “INH” is displayed while the Transmitter Lockout function is activated.
- 41 SELECT MEMORY CHANNEL ICON**
 Indicates that the displayed memory channel is assigned as a Select Memory channel ($\star 1 \sim \star 3$).
- 42 PLAY ICON**
 Displayed while playing the recorded voice audio.
- 43 DIAL LOCK INDICATOR (p. 3-9)**
 Displayed while the Lock function is ON.
- 44 AUTO TUNE ICON (p. 4-11)**
 Displayed when the Auto Tuning function is ON.

1 PANEL DESCRIPTION

Touch screen display (Main screen)

◇ MENU screen

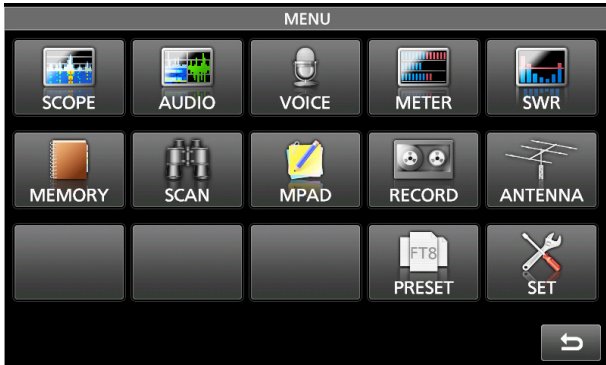

- Push **MENU** to open the MENU screen in the selected mode.
- ① To close the MENU screen, push **EXIT**.

◇ QUICK MENU

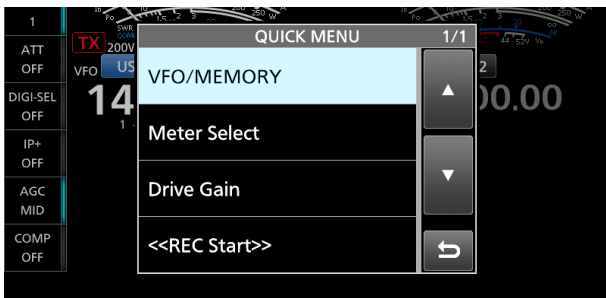

- Push **QUICK** to open the QUICK MENU screen.

◇ FUNCTION screen

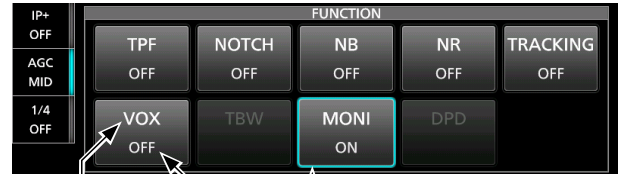

Function name
Status
Lights blue when in use

- Push **FUNCTION** to open the FUNCTION screen in the selected mode.
- ① To close the FUNCTION screen, push **EXIT**.
- ① You cannot use keys displayed in gray.

FUNCTION screen items

* Touch for 1 second to open its Multi-function menu.

APF*	TPF	NOTCH*	NB*
OFF	OFF	OFF	OFF
ON	ON	AN	ON
		MN	
NR*	TRACKING	VOX*	BKIN*
OFF	OFF	OFF	OFF
ON	ON	ON	BKIN
			F-BKIN
TBW	MONI*	DPD	
WIDE	OFF	OFF	
MID	ON	ON	
NAR			

Touch screen display (Main screen)

◇ Multi-function menus

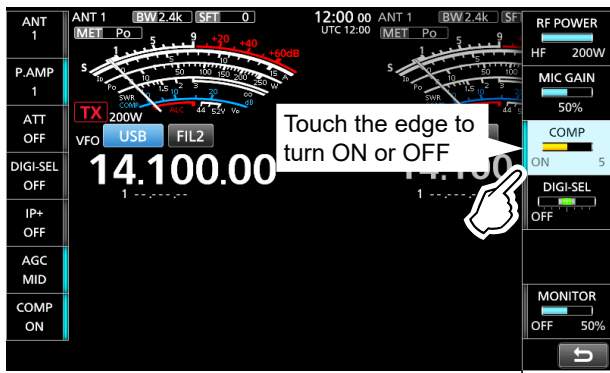

Multi-function menu

◇ Multi-function key group



Multi-function key group

- Open the Multi-function menu by pushing **[MULTI]** (Multi-function control).
 - ① You can open other menus by holding down **[NB]**, **[NR]**, **[NOTCH]**, **[APF/TPF]**, or **[VOX/BK-IN]** for 1 second, or touching key on the FUNCTION screen.
- While the Multi-function menu is open, touch the desired item and rotate **[MULTI]** to set the desired value.

Multi-function menu items

*1 Touch the item for 1 second to adjust by rotating **[MULTI]**, even when the Multi-function menu is closed.

*2 Touch the edge to turn the function ON or OFF, or to adjust the selected item.

SSB	SSB-D	CW	RTTY/PSK
RF POWER*1	RF POWER*1	RF POWER*1	RF POWER*1
MIC GAIN*1	MIC GAIN*1	KEY SPEED*1	
COMP*1*2		CW PITCH*1	
DIGI-SEL *1*2	DIGI-SEL *1*2	DIGI-SEL *1*2	DIGI-SEL *1*2
MONITOR*1*2	MONITOR*1*2	SIDETONE*1	MONITOR*1*2
AM/AM-D	FM/FM-D	NB	NR
RF POWER*1	RF POWER*1	LEVEL *1	LEVEL *1
MIC GAIN*1	MIC GAIN*1	DEPTH*1	
DIGI-SEL *1*2	DIGI-SEL *1*2	WIDTH*1	
MONITOR*1*2	MONITOR*1*2		
NOTCH	APF	ATT	VOX
POSITION*1	POSITION*1	LEVEL *1	GAIN*1
WIDTH*2	WIDTH*2		ANTI VOX*1
	TYPE*2		DELAY*1
	AF LEVEL*1		VOICE DELAY*2
BK-IN			
DELAY*1			

- Touch a key to turn the function ON or OFF.
- Touching “ATT,” “DIGI-SEL,” or “COMP” for 1 second opens the Multi-function menu.
- Touching “AGC” or “TONE” for 1 second opens the AGC or TONE menu.

Multi-function key group items

	SSB	SSB-D	CW/RTTY/PSK	AM/AM-D	FM/FM-D
ANT	✓	✓	✓	✓	✓
P.AMP	✓	✓	✓	✓	✓
ATT	✓	✓	✓	✓	✓
DIGI-SEL	✓	✓	✓	✓	✓
IP+	✓	✓	✓	✓	✓
AGC	✓	✓	✓	✓	✓
COMP	✓				
1/4		✓	✓		
TONE					✓

Multi-function dial

When the Multi-function menu is closed, the **MULTI** control can be enabled to adjust functions. The function is displayed in the upper right corner of the screen.



← Function indicator for **MULTI**

- To assign the function to the **MULTI** control, touch the item for 1 second on the Multi-function menus.

Assignable key functions

* Touch the function indicator, or hold down **MULTI** for 1 second to assign the function to the **MULTI** control.

Indicator	Action
kHz*	Changes the operating frequency in kHz steps. (VFO mode only)
M-CH*	Selects Memory channels. (Memory mode only)
RF PWR	Adjusts the transmit output power.
MIC G	Adjusts the microphone gain.
COMP	Adjusts the Speech Compressor level.
D-SEL	Adjusts the center frequency of the automatic preselector using the Digital Selector function.
MONI	Adjusts the audio level for the Monitor function.
SPEED	Adjusts the Keying speed.
PITCH	Adjusts the CW pitch.
S TONE	Adjusts the CW side tone output level.
NB LEV	Adjusts the Noise Blanker level.
NB DEP	Adjusts the DEPTH (Noise attenuation level).
NB WID	Adjusts the WIDTH (Blanking duration time).
NR LEV	Adjusts the Noise Reduction level.
APF	Adjusts the peak frequency of the APF.
APF LV	Adjusts the audio level of the APF.
NOTCH	Adjusts the Notch filter frequency.
VOX G	Adjusts the VOX gain.
A-VOX	Adjusts the ANTI VOX level
VOX D	Adjusts the VOX delay time.
BKIN D	Adjusts the Break-in delay time.
DRIV G	Adjusts the transmitter level at the driver stage.
ATT	Adjusts the attenuator level of up to 45 dB (in 3 dB steps).

Touch screen display (Sub screen)

You can display one of the following screens on the Sub screen for your convenience.

- Filter Effect screen
- Keypad screen
- Meter screen

● Push **SUB DISP** to select the screen.

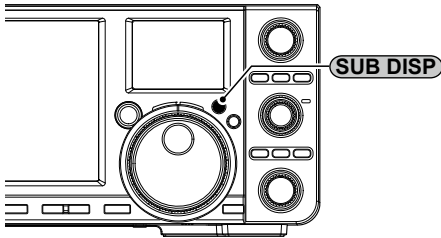

◇ Filter Effect screen

Displays the received signals and the filter passband width. You can check the filter (Digital Twin PBT, IF filter, or Notch Filter) removes the signals that are out of the passband.

① When using the Dualwatch or Split function, displays only the selected band (Main/Sub).

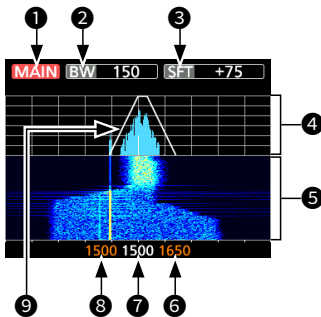

- 1 Main/Sub band icon
- 2 Passband width
- 3 Shift value
- 4 FFT scope zone
(FFT: Fast Fourier Transform)
- 5 Waterfall zone
- 6 Edge (Upper frequency)
- 7 Passband center frequency
- 8 Edge (Lower frequency)
- 9 Passband

◇ Keypad screen

You can select the operating band by pushing once, or call up other stacked frequencies by pushing the same key several times.

- ① The Band Stacking Register provides 3 memories for each band key to store frequencies and operating modes. To display the Band Stacking Register contents, touch the band key for 1 second.
- ① To directly enter the frequency using the Tenkey pad, touch [F-INP].

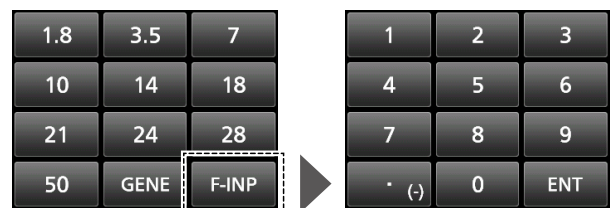

Band keypad

Tenkey pad

◇ Meter screen

Displays the meter indicator of the Main band.

- ① When the Split function is ON, displays the meter indicator of the Sub band.
- ① To select the displayed parameter, touch the meter.
- ① To change the displayed meter type, touch the meter for 1 second.

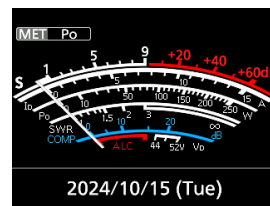

Normal

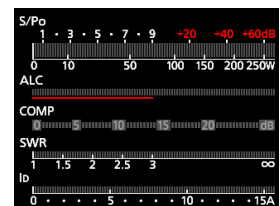

Multi-function meter

Selecting a location

CAUTION: Always have 2 people carry, lift, or turn over the RF deck.

Select a location for the transceiver that allows adequate air circulation, free from extreme heat, cold, or vibration, and other electromagnetic sources.

Never place the transceiver in areas such as:

- Out of the specified temperature range for the transceiver (0°C ~ 50°C, 32°F ~ 122°F).
- An unstable place that slopes or vibrates.
- In direct sunlight.
- High humidity and temperature environments.
- Dusty environments.
- Noisy environments.

Attaching the desktop stand

Use the 4 supplied screws to attach the desktop stand to the controller, as illustrated below.

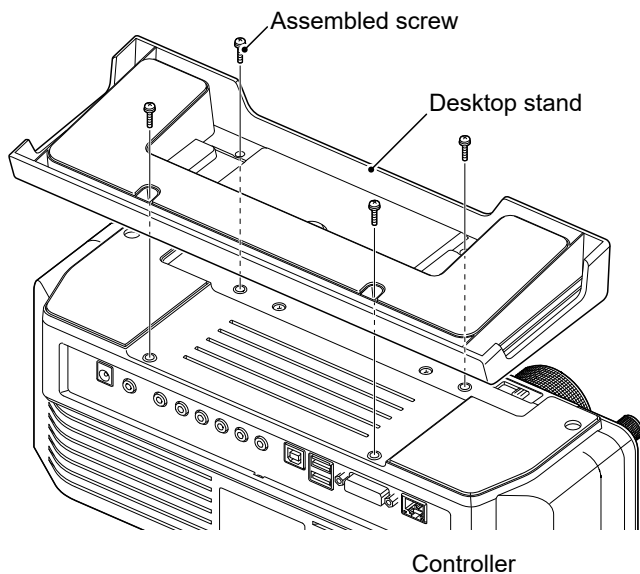

Heat dissipation

- **NEVER** install the transceiver in a place without adequate ventilation. Heat dissipation may be reduced, and the transceiver may be damaged.
- **DO NOT** place the transceiver against walls or put anything around the transceiver. This may block airflow and overheat the transceiver.
- **DO NOT** touch the RF deck after transmitting continuously for long periods of time. The panel may become hot.

Grounding

To prevent electrical shock, television interference (TVI), broadcast interference (BCI), and other problems, ground the RF deck using the ground terminal [GND] on the rear panel.

For best results, connect a heavy gauge wire or strap to a long ground rod. Make the distance between the [GND] terminal and ground as short as possible.

⚠ WARNING! NEVER connect the [GND] terminal to a gas or electric pipe, since the connection could cause an explosion or electric shock.

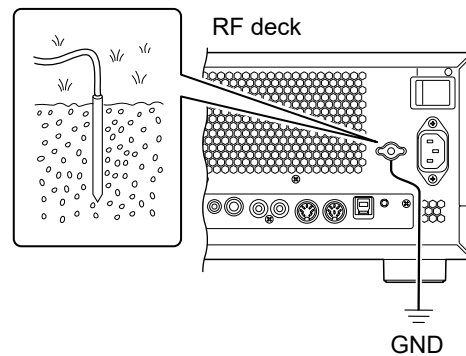

Before using the transceiver

Before using the transceiver for the first time, or after performing an All reset, directly connect the controller and the RF deck with a supplied control cable.

After turning ON the transceiver, the controller is automatically paired with the RF deck.

- ① See the next page for details about how to connect.
- ① If the controller and RF deck are not paired, "The RF deck is not detected." is displayed.

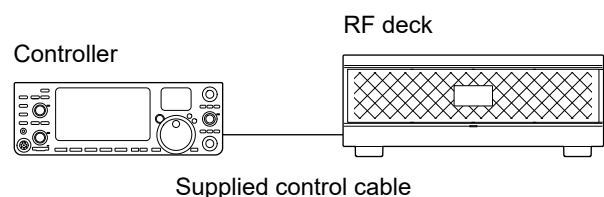

Connecting the controller and RF deck

Confirm that the controller and RF deck are OFF before connecting cables.

NOTE: Operation cannot be guaranteed if:

- You use a cable other than the specified one.
- You connect the controller's [RF DECK] port and RF deck's [CONTROLLER] port through a network switch.

2

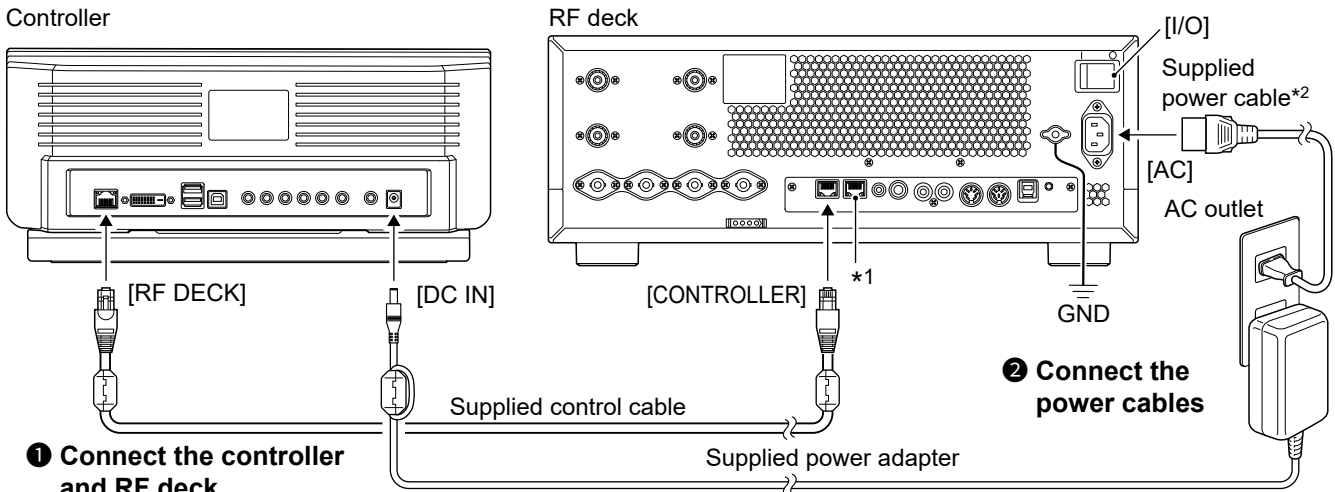

*1 **DO NOT** connect the controller's [RF DECK] port to the RF deck's [LAN] port with the supplied control cable.

① The RF deck's [LAN] port is used to connect the IC-7760 to a network (LAN or Internet).

See the Advanced manual for details about how to connect the controller and RF deck through a network.

*2 Only the power cable supplied with the EUR version can be used to connect to a 180 ~ 264 V AC power source.

For other versions, use a power cable that matches the power source if you connect to a 180 ~ 264 V AC power source.

Connecting the AH-730

The AH-730 ANTENNA TUNER provides reliable matching from 1.8 to 54 MHz when using at least a 7 m (23 ft) antenna.

① While the AH-730 is connected, the internal antenna tuner is deactivated.

NOTE:

- Before connecting, be sure to turn OFF the transceiver.
- Set "External Antenna Tuner Connection" to the antenna connector to which the AH-730 optional antenna tuner is connected. The maximum output power from selected connector is limited to 100 W. (Default: ANT 1)

MENU » ANTENNA > TYPE > External Antenna Tuner Connection

If you connect the AH-730 to another connector, the maximum 200 W power is input to the tuner, and could damage the tuner.

① Confirm the setting again after performing a Partial reset or an All reset.

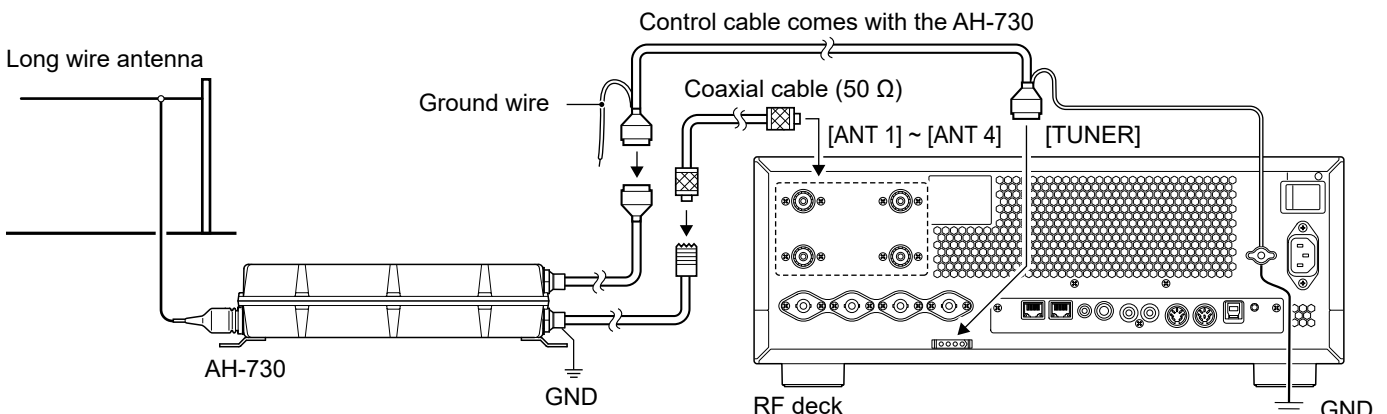

Connecting a linear amplifier

◇ Connecting the IC-PW2

See the illustration below to connect the optional IC-PW2.
Refer to the amplifier's instruction manual for operation.

⚠ WARNING! When using a linear amplifier such as the IC-PW2, set the RF POWER in the Multi-function menu to keep the ALC meter in the red zone. (pp. 3-10, 3-11)

When connecting the IC-7760 to either [INPUT 1] or [INPUT 2]

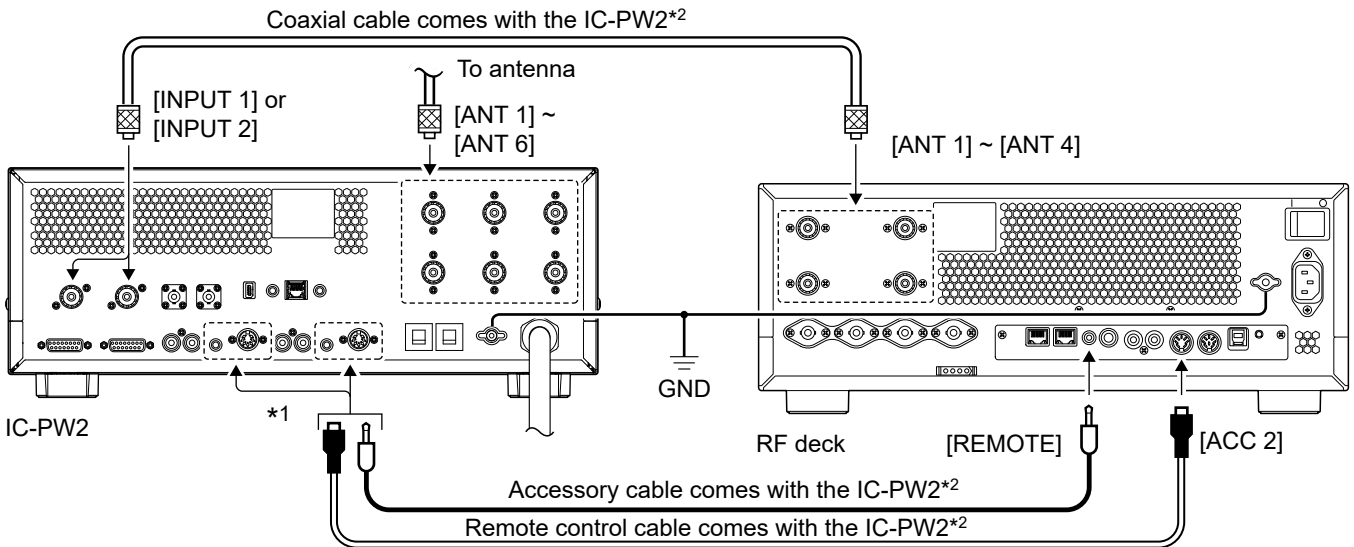

- *1 When you connect a coaxial cable to [INPUT 1], connect to [REMOTE 1] and [ACC 1].
When you connect a coaxial cable to [INPUT 2], connect to [REMOTE 2] and [ACC 2].
- *2 To connect the second Icom exciter, use the optional OPK-5 CABLE KIT.

When connecting the IC-7760 to both [INPUT 1] and [INPUT 2]

To operate the amplifier in synchronization with the IC-7760's frequency data, disconnect the AH-730, and then set "IC-PW2 Dual Connection Mode" to "ON."

MENU » SET > function > **IC-PW2 Dual Connection Mode**

- ⓐ When "IC-PW2 Dual Connection Mode" is set to "ON," maximum output power is not limited. Therefore maximum 200 W power is input to the AH-730, and could damage the AH-730.

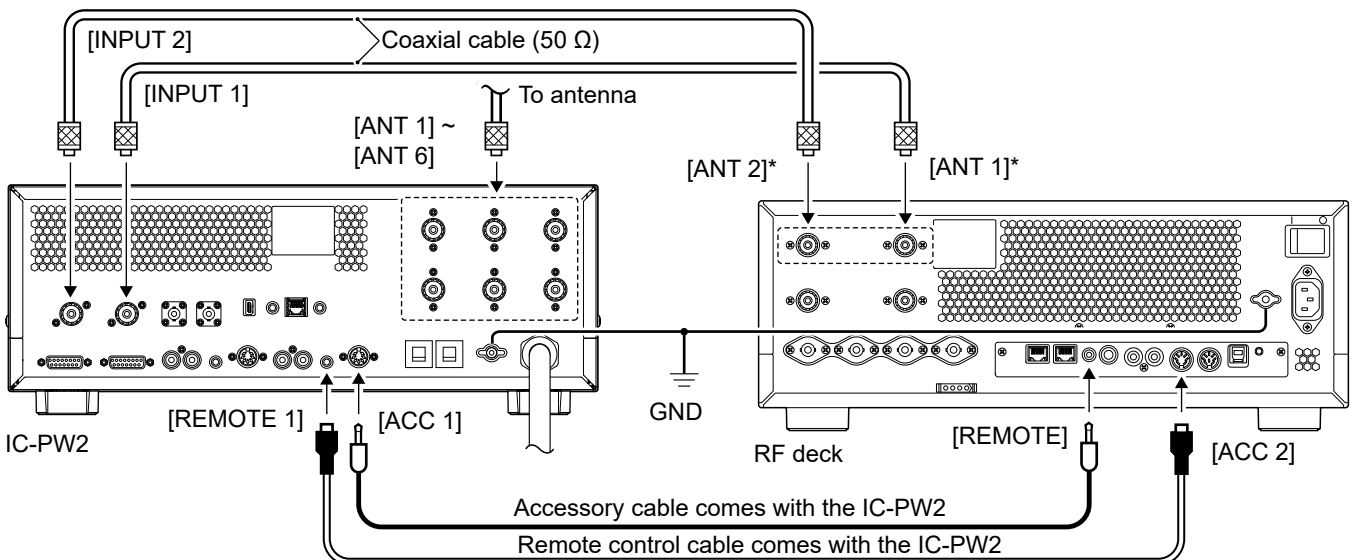

- * The IC-PW2 is designed to work by connecting a coaxial cable to the transceiver's [ANT 1] and [ANT 2].

Connecting a linear amplifier

◇ Connecting a non-Icom linear amplifier

See the illustration below to connect a non-Icom linear amplifier.

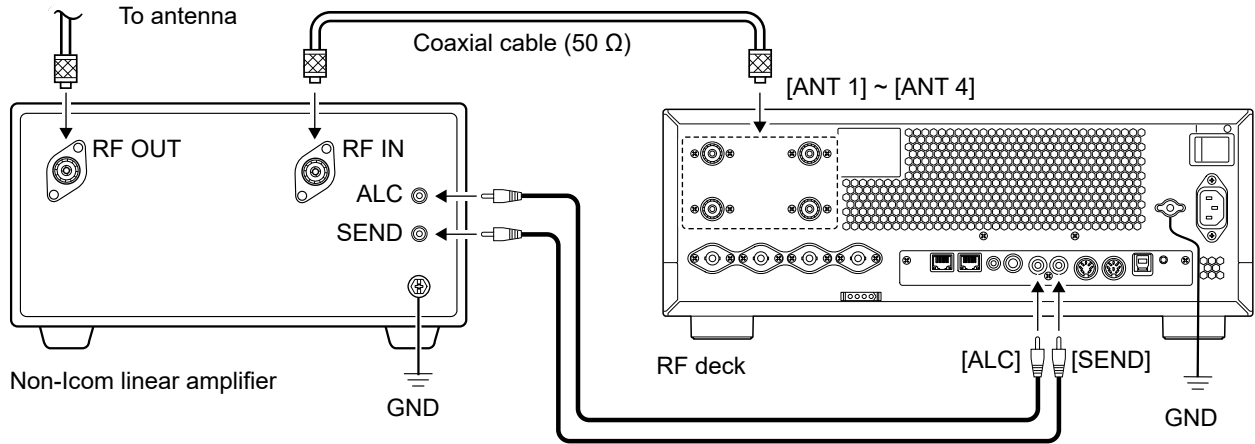

⚠ WARNING!

- The maximum signal level of the [SEND] jack is 16 V/0.5 A DC with the “Reed” setting, and 250 V/200 mA with the “MOSFET” setting. Use an external unit if your non-Icom linear amplifier requires a control voltage and/or current greater than specified.

MENU » SET > Connectors > **SEND Relay Type**

- The ALC input level must be in the range 0 to -4 V. The transceiver does not accept a positive voltage. Non-matched ALC and RF power settings could overheat or damage the linear amplifier.
- When using a linear amplifier that has a time delay between receiving and transmitting, a high SWR might cause the linear amplifier to malfunction. To prevent this, set “TX Delay.”

MENU » SET > Function > **TX Delay**

Connecting a Transverter

When you use a non-Icom transverter unit, connect it as described below.

- Confirm that the transceiver and transverter are OFF before connecting them.
- You may need to connect to [ALC], depending on the transverter.

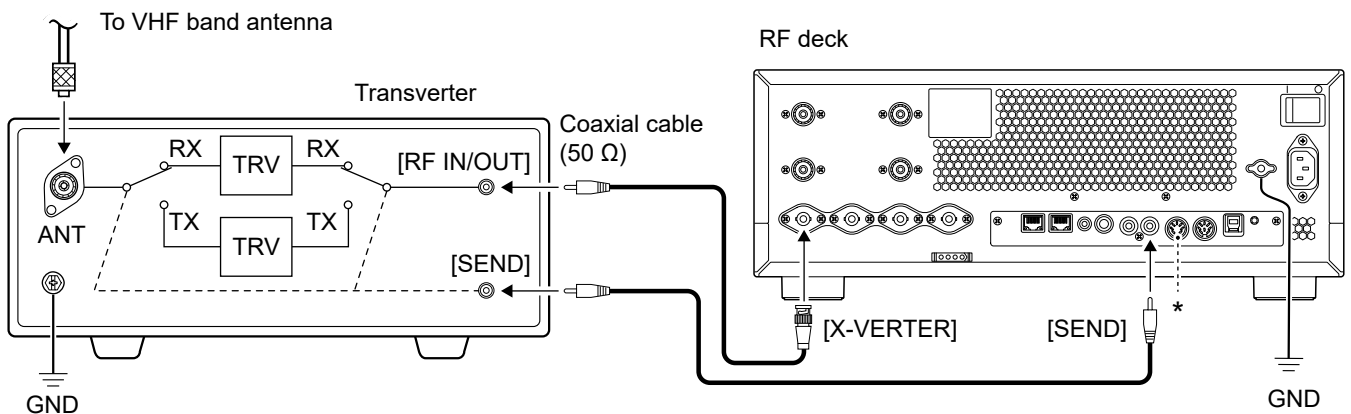

- To use the transverter operating mode, set “Transverter Function” to “ON.”

* You can also use the transverter operating mode by connecting a DC voltage to [ACC 2 (6: TRV)].

MENU » SET > Function > **Transverter Function**

- Set the offset frequency for the transverter operation.

MENU » SET > Function > **Transverter Offset**

When first applying power

Before turning ON your transceiver for the first time, make sure all connections are correctly made.

After all connections are made, set the dials to the positions described below.

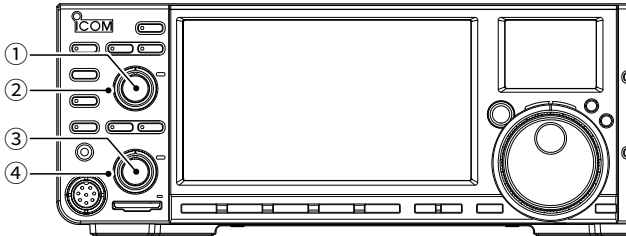

- ① MAIN (AF→RF/SQL) (inner): Fully counterclockwise
- ② MAIN (AF→RF/SQL) (outer): 12 o'clock
- ③ SUB (AF→RF/SQL) (inner): Fully counterclockwise
- ④ SUB (AF→RF/SQL) (outer): 12 o'clock

TIP: When you turn OFF the transceiver, it memorizes the current settings. Therefore, when you turn ON the transceiver again, it restarts with the same settings.

Turning power ON or OFF

◇ Turning ON the RF deck

- To turn ON the RF deck, push [I/O] on the rear panel.
 - The [POWER] indicator on the front panel lights orange.
 - ① If the controller is already ON, the [POWER] indicator lights blue after the connection is successful.
- To turn OFF the RF deck, turn OFF the controller, and then push [I/O].

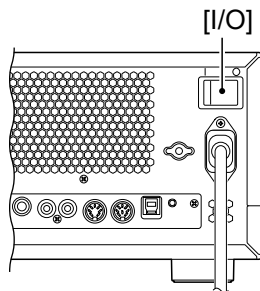

◇ Turning ON the controller

- To turn ON the controller, push **POWER**.
 - ① The [POWER] indicator on the RF deck's front panel lights blue after the connection is successful.
- To turn OFF the controller, hold down **POWER** for 1 second until "POWER OFF..." is displayed.

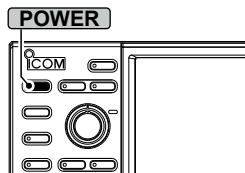

NOTE: We recommend you set the time before operating. See Section 9 for details.

Adjusting the volume level

Rotate (AF→RF/SQL) (inner) to adjust the volume level.

Selecting the mode

VFO mode

Set the desired frequency by rotating **MAIN DIAL**.

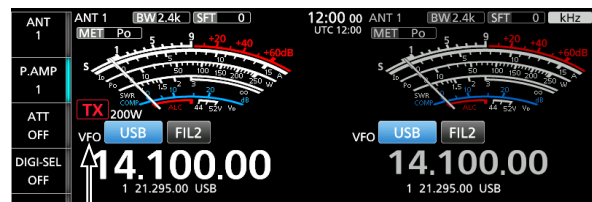

VFO indicator

Memory mode

Enter contents into the desired channel in the MEMORY list.

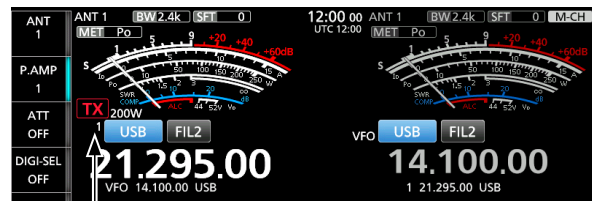

Memory channel number

Selecting the VFO or Memory mode

1. Touch the VFO/MEMORY icon.

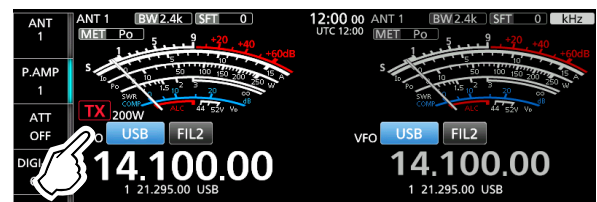

- Opens the VFO/MEMORY screen.
- ① You can also select the mode by touching "VFO/MEMORY" on the QUICK MENU screen.

2. Touch [VFO] or [MEMORY].



3. To close the VFO/MEMORY screen, push **EXIT**.

Selecting the Main and Sub bands

The IC-7760 has 2 identical receivers, Main and Sub. The Main band is displayed on the left side of the screen, and the Sub band is displayed on the right side. Some functions can only be applied to the selected band, and you can transmit on only the Main band (except in Split Frequency operation).

- To select the Main band or Sub band, touch the frequency readout.

The Main band is selected.

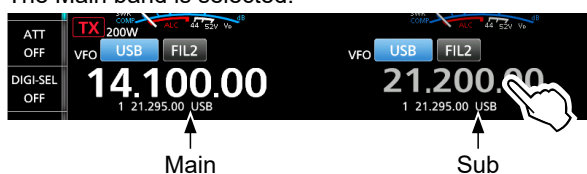

The Sub band is selected.

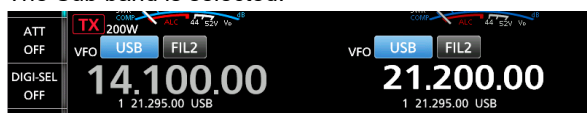

- The selected band's frequency readout is displayed clearly, and the frequency of the non-selected band is grayed.
- The selected band's indicator lights as shown below.
- When the Filter Effect screen is displayed on the Sub screen, the Sub screen's displayed band is also changed.

Example: When the Sub band is selected, the MAIN/ SUB indicator lights on the Sub band side.

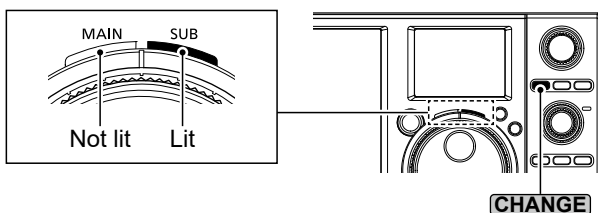

◇ Switching the Main band and Sub band

You can switch the Main band and Sub band settings, such as the operating frequency, mode, and so on.

- Push **CHANGE**.
 - The Main and Sub band settings are switched.
- To copy the Main band settings to the Sub band, hold down **CHANGE** for 1 second.



Dualwatch operation

Dualwatch simultaneously monitors two frequencies. The IC-7760 has 2 independent receiver circuits, the Main and Sub bands, so that you can use Dualwatch with no compromises, even on different bands and modes.

- Push **DUAL-W** briefly to start the Dualwatch operation.
 - "DUAL-W" is displayed.
- To equalize the Sub band frequency and mode to those of the Main band, hold down **DUAL-W** for 1 second. You can select whether to turn this Quick Dualwatch function ON or OFF in the following setting. (p. 8-4)

MENU » **SET** > **Function** > **Quick Dualwatch**

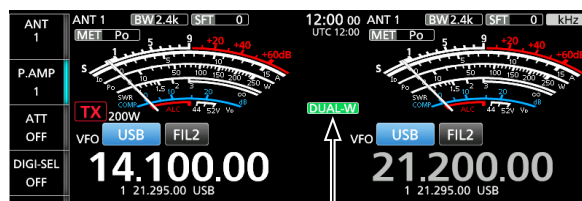

Displayed

- Touch the frequency readout of the band you want to set the frequency.
 - The selected band's frequency readout is displayed clearly, and the frequency of the non-selected band is grayed.
 - The selected band's indicator lights as shown below.
 - When the Filter Effect screen is displayed on the Sub screen, the Sub screen's displayed band is also changed.

Example: When the Main band is selected, the MAIN/ SUB indicator lights on the Main band side.

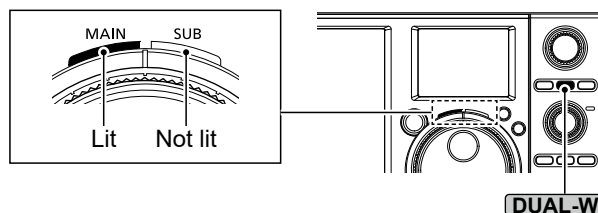

Selecting the operating band

◇ Selecting the operating band on the Sub screen

1. Push **[SUB DISP]** several times to display the Keypad screen.
2. Touch a band keypad. (Example: 14)
 - Displays a 14 MHz frequency.

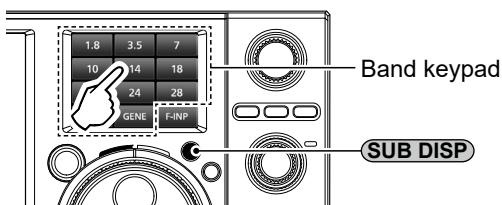

Main screen



◇ Selecting the operating band on the Main screen

1. Touch the MHz digits. (Example: 21)



- Opens the BAND STACKING REGISTER screen.
2. Touch a band key. (Example: 14)
 - Displays a 14 MHz frequency.



TIP: About the Band Stacking Register

The Band Stacking Register provides 3 memories for each band. When you change the operating band or the Register, the previously operated frequency and mode are stored.



To display the Band Stacking Register contents:

- Touch the band key for 1 second.
 - Touch the MHz digits for 1 second on the standby screen.
- ① Touch **[↩]** to return to the previous screen.

Selecting the operating mode

You can select between the SSB (LSB/USB), SSB data (LSB-D/USB-D), CW, CW reverse, RTTY, RTTY reverse, PSK, PSK reverse, AM, AM data (AM-D), FM, and FM data (FM-D) modes.

1. Touch the mode icon (Example: USB).



- Opens the MODE screen.

2. On the MODE screen, touch the desired mode key. (Example: CW)



- ① In the SSB, AM, or FM modes, the [DATA] key is displayed.

Operating mode selection list

- ① Touch the mode key to select the operating mode.

Mode key	Operating mode	
[SSB]	USB	LSB
[CW]	CW	CW-R
[RTTY]	RTTY	RTTY-R
[PSK]	PSK	PSK-R
[AM]	AM	
[FM]	FM	
[DATA]	LSB	LSB-D*
	USB	USB-D*
	AM	AM-D*
	FM	FM-D*

* Touching [DATA] for 1 second selects DATA1, DATA2, or DATA3.

Selecting the Data mode

You can operate data communications (SSTV, RTTY (AFSK), PSK31, JT65B, and FT8).

- ① You can select the connector(s) to input the modulation signal when the data mode is selected.

MENU » SET > Connectors > MOD Input > **DATA1 MOD ~ DATA3 MOD**

- ① In the PRESET menu, you can save the combination of the settings for the data mode to quickly change the settings, depending on your operating needs. See the Advanced manual for details.

3

Setting the frequency

◇ Using the Main Dial

1. Select the desired operating band. (p. 3-3)
2. Rotate **(MAIN DIAL)**.
 - The frequency changes according to the selected Tuning Step.
 - ① **TX** is displayed when you select an amateur radio frequency, and **TX** (with a dotted line) is displayed when you select a frequency outside the Ham band, or outside your set Band Edges.

◇ About the Tuning Step function

You can set the **(MAIN DIAL)**'s tuning step for each operating mode.

- Touch the kHz digits to turn the Tuning Step function ON or OFF.
 - The Tuning Step function's icon "▼" is displayed above the 1 kHz digit.

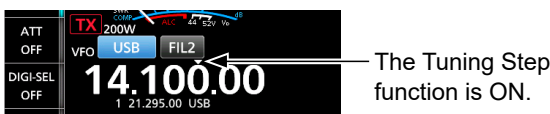

◇ Changing the Tuning Step

When the Tuning Step function is ON, you can change the tuning steps for each operating mode.

1. Select the desired operating mode. (p. 3-4) (Example: USB)
2. Touch the kHz digit for 1 second.



- Opens the TS (SSB) screen.
3. Touch the desired tuning step. (Example: 0.1 k)



- The tuning step is set, and returns to the previous screen.

◇ About the 1 Hz step Fine Tuning function

You can use the minimum tuning step of 1 Hz for fine tuning.

- Touch the Hz digits for 1 second to turn the Fine Tuning function ON or OFF.
 - ① When using the [UP]/[DN] keys on the microphone, the frequency changes in 50 Hz steps with the Fine Tuning function ON or OFF.

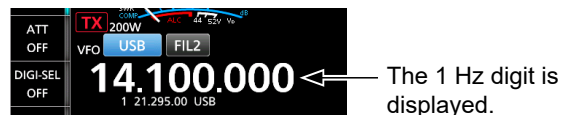

◇ About the 1/4 Tuning function SSB-D, CW, RTTY, and PSK modes

With the Tuning Function OFF, turn ON the 1/4 Tuning function to reduce the tuning speed to 1/4 of the normal speed, for finer tuning.

- Touch [1/4] to turn the 1/4 Tuning function ON or OFF.

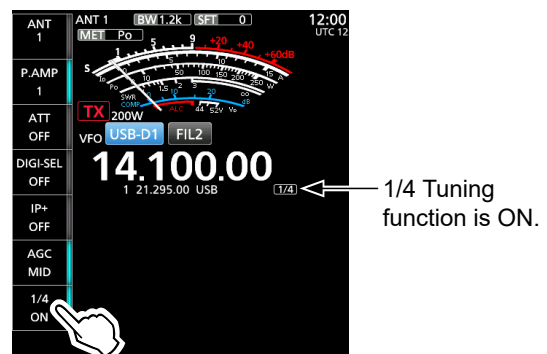

◇ About the Auto Tuning Step function

The tuning step automatically changes, depending on the rotation speed of **(MAIN DIAL)**.

- ① You can change the Auto Tuning Step function settings in the following setting. (p. 8-6)

[MENU] » [SET > Function > MAIN DIAL Auto TS]

Setting the frequency

◇ Directly entering a frequency

You can set the frequency without rotating **(MAIN DIAL)** by directly entering it using the keypad.

Entering the operating frequency on the Sub screen

1. Push **(SUB DISP)** several times to display the Keypad screen.
2. Touch **[F-INP]**.

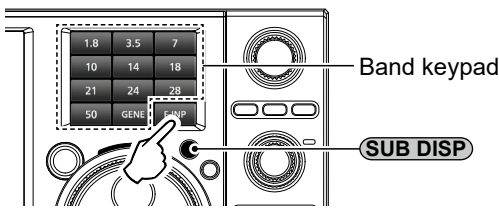

- Opens the Tenkey pad.
3. Start entry with the most significant digit.

Sub screen



Main screen



- ① To clear the entry, touch **[CE]**.
 - ① To clear the entry and return to the previous screen, push **(SUB DISP)**.
4. Touch **[ENT]** to set the entered frequency.
 - Returns to the Band keypad.
 - ① If you touch **[ENT]** when the digits under 100 kHz are not entered, "0" will be automatically entered into the digits that are blank.

Entering the operating frequency on the Main screen

1. Touch the MHz digits. (Example: 21)
 - Opens the BAND STACKING REGISTER screen.
2. Touch **[F-INP]**.

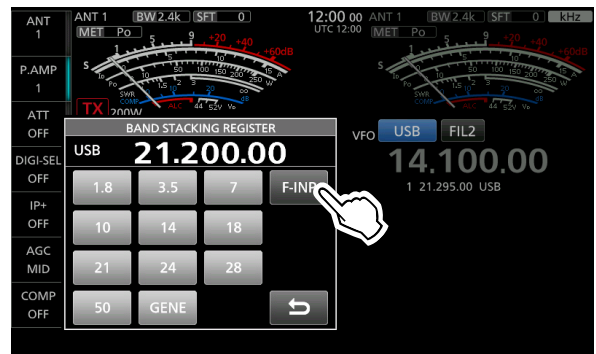

- Opens the F-INP screen.
3. Start entry with the most significant digit.



- ① To clear the entry, touch **[CE]**.
 - ① To clear the entry and return to the previous screen, push **(EXIT)**.
4. Touch **[ENT]** to set the entered frequency.
 - Closes the F-INP screen.
 - ① If you touch **[ENT]** when the digits under 100 kHz are not entered, "0" will be automatically entered into the digits that are blank.

Entry examples

- 14.025 MHz: [1], [4], [**(-)**], [0], [2], [5], [ENT]
- 18.0725 MHz: [1], [8], [**(-)**], [0], [7], [2], [5], [ENT]
- 730 kHz: [0], [**(-)**], [7], [3], [ENT]
- 5.1 MHz: [5], [**(-)**], [1], [ENT]
- 7 MHz: [7], [ENT]

- Changing from 21.28 MHz to 21.245 MHz: [**(-)**], [2], [4], [5], [ENT]
- ① Touching [**(-)**] first enters the same MHz digits as the operating frequency.

3 BASIC OPERATION

Setting the frequency

◇ Directly entering a frequency

Entering the Split Frequency Offset on the Main screen

1. Touch the MHz digits. (Example: 14)
 - Opens the BAND STACKING REGISTER screen.
2. Touch [F-INP].

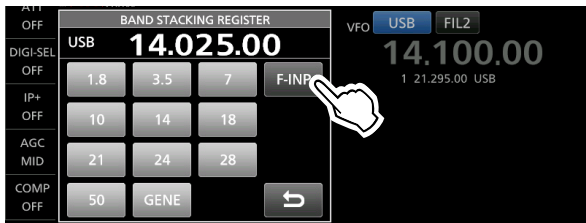

- Opens the F-INP screen.
3. Enter the Split Frequency Offset.

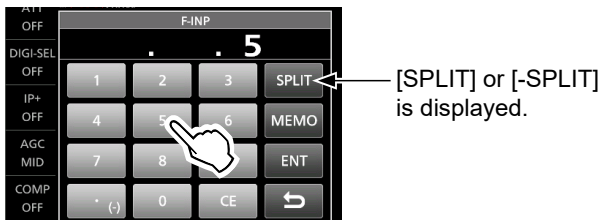

① Information

- If you want the minus shift direction, touch [-(-)].
 - Enter the offset between -9.999 MHz and +9.999 MHz (1 kHz steps).
 - To clear the entry, touch [CE].
 - To clear the entry and return to the previous screen, touch [↩].
4. To save the entry, touch [SPLIT] or [-SPLIT].
 - Closes the F-INP screen.
 - The Split function is automatically turned ON.

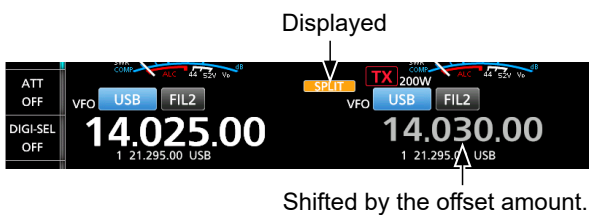

Entering the Split Frequency Offset on the Sub screen

1. Push **[SUB DISP]** several times to display the Keypad screen.
2. Touch [F-INP].

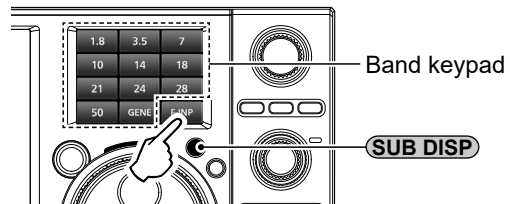

- Opens the Tenkey pad.
3. Enter the Split Frequency Offset.

Sub screen



Main screen



4. To save the entry, push **[SPLIT]**.
 - Returns to the Band keypad.
 - The Split function is automatically turned ON.

Main screen

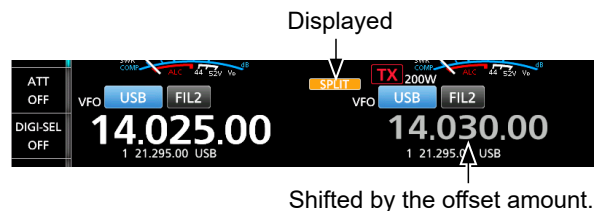

Entry examples

• 5 kHz: [5], [SPLIT]

• -10 kHz: [-(-)], [1], [0], [-SPLIT]

NOTE: If the entered operating frequency is out of an amateur band's frequency range, the transmit frequency is automatically set to the band edge frequency.

Setting the frequency

◇ Directly entering a frequency

Selecting a Memory channel by number

1. Select the Memory mode. (p. 3-1)
2. Touch the MHz digits. (Example: 21)

Memory mode



- Opens the BAND STACKING REGISTER screen.

3. Touch [F-INP].

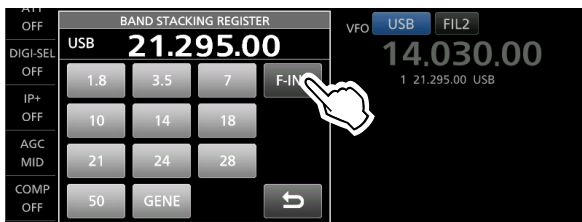

- Opens the F-INP screen.

4. Enter a Memory channel number. (Example: 3)



① If you want to set a Program Channel number (P1 or P2), enter “100” for P1 or “101” for P2.

5. Touch [MEMO] to set the memory channel of the entered number.
 - Closes the F-INP screen.
 - The selected memory channel contents are displayed.

RF gain and SQL level

Rotate **(AF)RF/SQL** (outer) to adjust the RF gain and SQL level.

By default, rotating to the left (when set to the 12 o'clock position) adjusts the RF gain, and rotating to the right adjusts the squelch level, as described below.

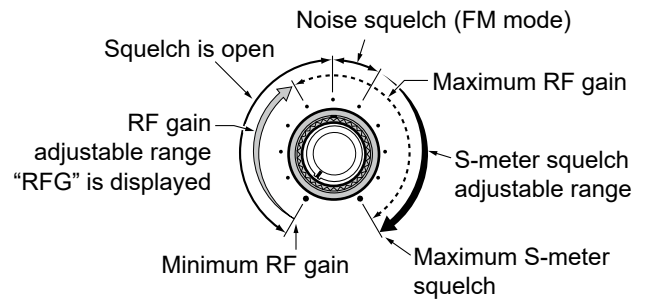

RF gain

You can adjust the receive sensitivity.

If a strong interfering signal is received, rotate **(AF)RF/SQL** (outer) counterclockwise to reduce the RF gain.

- ① “RFG” is displayed when the RF gain is reduced.
- ① If a strong signal is received and “OVF” (Overflow) is displayed, reduce the RF gain until “OVF” disappears.

Squelch (SQL) level

There are 2 types of SQL levels, depending on the operating mode.

• Noise squelch

Rotate **(AF)RF/SQL** (outer) until the noise just disappears and the TX/RX indicator goes OFF.

- ① Activates only in the FM mode.

• S-meter squelch

The S-meter squelch disables the audio output from the speaker or headphones when the received signal is weaker than the specified S-meter squelch level. Rotate **(AF)RF/SQL** (outer) clockwise from the 12 o'clock position to increase the S-meter threshold level.

- ① You can change the **(AF)RF/SQL** (outer) control type in the following setting. (p. 8-4)

[MENU] » [SET > Function > RF/SQL Control]

- ① When the Meter type is set to “Bar” or on the MULTI-FUNCTION METER screen, “▼” indicates the S-meter squelch level.

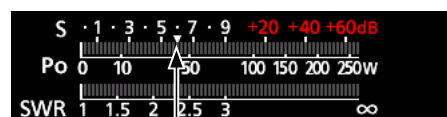

S-meter squelch level

Selecting the antenna connector

Set the antenna connector to between “ANT 1” and “ANT 4,” and turn the receive antenna connector ON or OFF.

1. Select the Main band or Sub band.
2. Select the operating band.
3. Touch [ANT] in the Multi-function key group to set to between “ANT 1” and “ANT 4.”

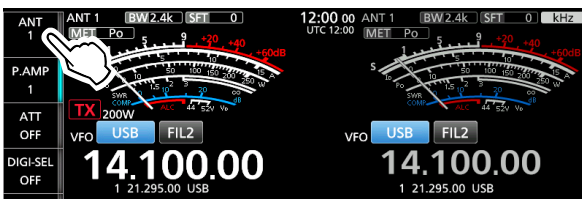

- ① Touching [ANT] changes the antenna connector between “ANT 1,” “ANT 2,” “ANT 3,” and “ANT 4.”
- ① Touch [ANT] for 1 second to set the antenna that is connected to the selected antenna connector for transmitting, and the antenna connected to [RX-ANT IN] for receiving.

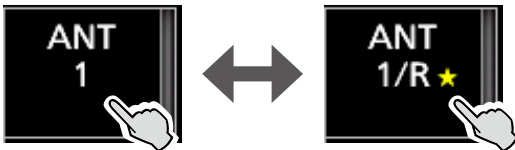

- ① “★” is displayed if you temporarily select an antenna that is different from the one that is saved in memory.
- Touch [ANT MW] for 1 second to save the temporary selection into memory, then “★” disappears.

MENU » ANTENNA > ANT MW

- ① When the antenna selection mode ([ANT] SW) is set to “Manual,” each antenna connector is selected according to the saved settings.

MENU » ANTENNA > [ANT] SW

When not using the [RX-ANT] connector:

Set to between “ANT 1” and “ANT 4.”

- ① When “ANT 1/R” ~ “ANT 4/R” is selected, the signal is switched to the [RX-ANT IN] connector, and then reception in [ANT 1] ~ [ANT 4] is disconnected.

When an optional antenna tuner is connected:

When an optional antenna tuner is connected to the antenna connector set to “External Antenna Tuner Connection,” “(EXT)” is displayed.



Dial Lock function

The Dial Lock function prevents frequency changes caused by accidentally moving (MAIN DIAL).

- ① This function electronically locks the dial.

- Hold down **SPEECH** for 1 second to turn the Dial Lock function ON or OFF.

- **KEY** is displayed while the function is ON.

- ① You can select the Dial lock or Panel lock. (p. 8-6)

MENU » SET > Function > Lock Function

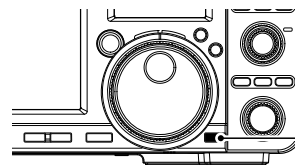

Hold down **SPEECH** for 1 second.

Basic transmission

1. Hold down [PTT] (or push **TRANSMIT**) to transmit.
 - The TX/RX indicator lights red, and **TX** is displayed.
2. Release [PTT] (or push **TRANSMIT** again).
 - Returns to receive.

Adjusting the microphone gain

1. Set the operating band and mode to SSB, AM, or FM. (p. 3-3)
2. Push **MULTI** to open the Multi-function menu.
3. Hold down [PTT] on the microphone.
 - The TX/RX indicator lights red, and **TX** is displayed.
4. Touch [MIC GAIN], and rotate **MULTI** to adjust the microphone gain.

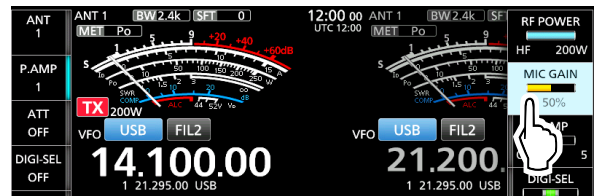

① Information

- Hold the microphone 5 to 10 cm (2 to 4 inches) from your mouth, then hold down [PTT] on the microphone and speak at your normal voice level.
 - In the SSB mode, display the ALC meter, and rotate to adjust the microphone gain until the meter reading swings between 30 to 50% of the ALC scale.
 - In the AM or FM mode, check the audio clarity with another station, or use the Monitor function (p. 4-8).
5. Release [PTT].
 - Returns to receive.

Adjusting the transmit output power

Before transmitting, monitor your selected operating frequency to make sure you do not cause interference to other stations on the same frequency. It is good amateur practice to listen first, and then, even if nothing is heard, ask if the frequency is in use once or twice, before you start operating.

1. Select the operating mode. (p. 3-4)
(Example: RTTY)
2. Touch the meter, and then touch [Po] to display the Po meter. (p. 3-11)

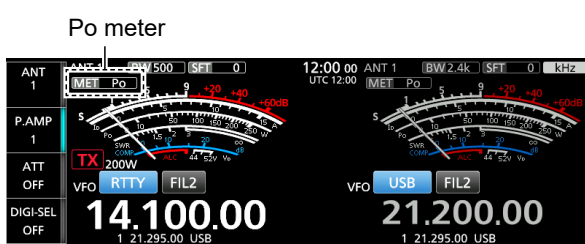

3. Push **[MULTI]** to open the Multi-function menu.
4. Hold down **[PTT]** on the microphone.
 - The TX/RX indicator lights red, and **TX** is displayed.
 - The Po meter level changes according to your voice level in the SSB mode. It becomes the S-meter while receiving.
5. Touch **[RF POWER]**, and rotate **[MULTI]** to adjust the transmit output power between 2 W and 200 W, or “< 2 W.”

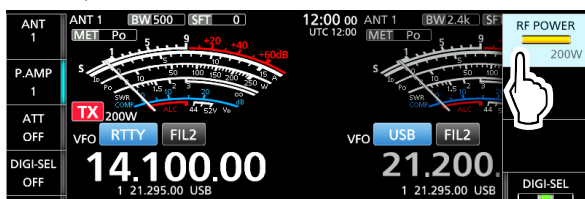

- ① In the AM mode, the maximum transmit output power is a quarter of the other mode's output.
- ① The transmit output power is limited to the maximum transmit output power.
6. Release **[PTT]**.
 - Returns to receive.

Transmit Power Limit function

The Transmit Power Limit function limits the output power to the preset level for each band.

1. Open the TX POWER LIMIT screen.
[MENU] » **[SET > Function > TX Power Limit]**
2. Touch the desired band to limit the output power. (Example: 3.5M)

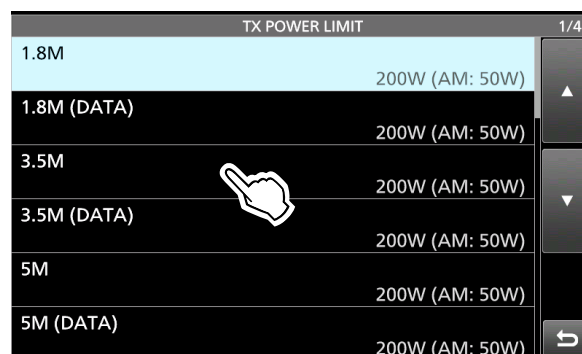

3. Touch **[+]** or **[-]** to set the maximum transmit output power. (Example: 50 W)
4. Touch **[SAVE]** to save the maximum transmit output power.



- Returns to the previous screen.
5. To close the TX POWER LIMIT screen, push **[EXIT]** several times.

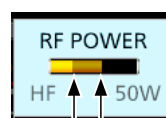

Set transmit output power

Limited transmit output power

① Even when set RF POWER exceeds the TX POWER LIMIT setting, the actual output power is limited to this value.

3

Meter display on the Main screen

◇ Selecting the Meter display

You can display one of the 6 different transmit parameters (Po, SWR, ALC, COMP, Vd, and Id) for your convenience.

① See "Touch screen display (Sub screen)" for details about the Meter display on the Sub screen. (p. 1-10)

- To select the displayed parameter, touch the meter.

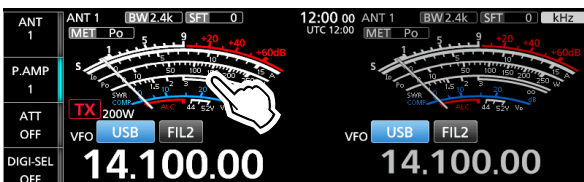

- Touch the key to display one of the meters. (Example: ALC)



① Touching [Multi-function] displays the Multi-function meter.

② You can also select the displayed parameter on the QUICK MENU screen.

The selected meter's icon is displayed.

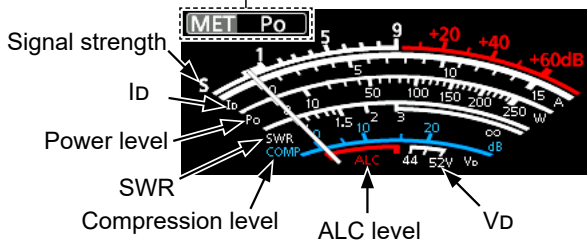

◇ Selecting the Meter type

You can select the Meter type in the following setting.

MENU » **SET** > **Display** > **Meter Type (Normal Screen)**

When selecting "Edgewise"

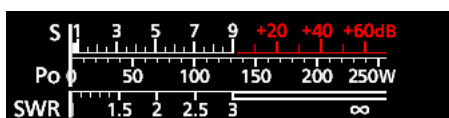

When selecting "Bar"

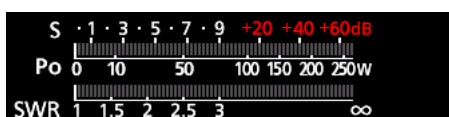

◇ Multi-function meter

You can simultaneously display all the parameters.

① The TEMP meter is also displayed on the Multi-function meter.

- Touch the currently displayed parameter for 1 second to display the Multi-function meter.
 - ① To close the MULTI-FUNCTION METER screen, push **EXIT**.
- While the Multi-function meter is displayed, touch [P-HOLD] to turn the Peak Level Hold function ON or OFF.

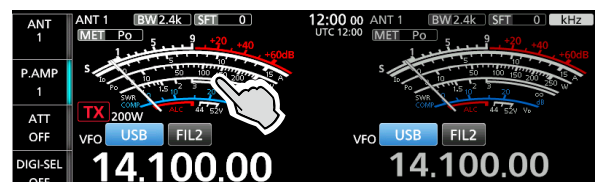

Displayed when Peak Hold function is ON.

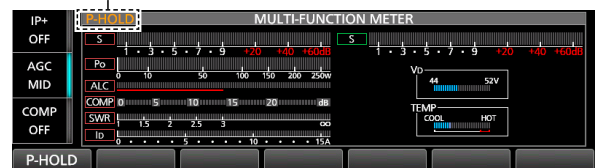

Power down transmission zone

Displays the temperature of the final amplifier MOS-FETs.

- S:** Displays the receiving signal strength level.
- Po:** Displays the relative RF output power.
- SWR:** Displays the SWR of the antenna at the selected frequency.
- ALC:** Displays the ALC level. When the meter movement shows the input signal level exceeds the allowed level, the ALC limits the RF power. In such case, decrease the microphone gain level.
- COMP:** Displays the compression level when the speech compressor is used.
- Vd:** Displays the drain voltage of the final amplifier MOS-FETs.
- Id:** Displays the drain current of the final amplifier MOS-FETs.
- TEMP:** Displays the temperature of the final amplifier MOS-FETs.

Preamplifiers

The preamp amplifies received signals in the receiver front end to improve the signal-to-noise ratio and sensitivity. A preamp is used when receiving weak signals.

① Each band memorizes the Preamplifier setting.

● Touch [P.AMP].

① Touching [P.AMP] selects “P.AMP 1,” “P.AMP 2,” and “P.AMP OFF.”



P.AMP 1	Wide dynamic range preamplifier. It is most effective for the HF low bands. <ul style="list-style-type: none"> • Gain is approximately 12 dB.
P.AMP 2	High-gain preamplifier. It is most effective for the higher bands. <ul style="list-style-type: none"> • Gain is approximately 20 dB.

NOTE: When you use the preamp while receiving strong signals, the receiving signal may be distorted. In such case, turn OFF the preamp.

Attenuator

The Attenuator prevents a desired signal from becoming distorted when a very strong signal is near the frequency, or when a very strong electric field, such as from a broadcasting station, is near your location.

① Each band memorizes the Attenuator setting.

● Touch [ATT] to set the Attenuator up to 18 dB in 6 dB steps.



You can also set the Attenuator in 3 dB steps:

1. Touch [ATT] for 1 second.



2. Rotate [MULTI] to adjust the Attenuator level of up to 45 dB.

① If a strong signal is received and “OVF” (Overflow) is displayed, turn ON the Attenuator or Digital Selector function, or decrease the RF gain until “OVF” disappears.

RIT function

The Receiver Incremental Tuning (RIT) function compensates for differences in frequencies of other stations.

The function shifts your receive frequency up to ±9.99 kHz without shifting the transmit frequency.

1. Push [RIT].

• The RIT function turns ON.

① While using the Fine Tuning function (p. 3-5), the RIT frequency is displayed in 4 digits, instead of 3.

① Pushing [RIT] turns the RIT function ON or OFF.

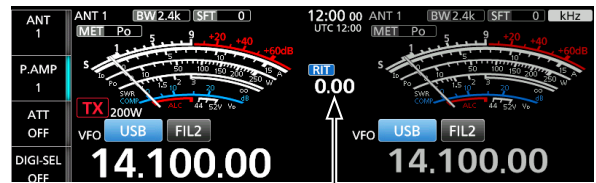

RIT frequency (3 digits)

2. Rotate [RIT/ΔTX] to set the RIT frequency to match the received station's transmit frequency.

① You can reset the RIT frequency to “0.00” by holding down [CLEAR] for 1 second.

3. After communicating, push [RIT] to turn OFF the RIT function.

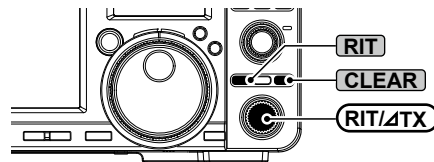

① You can change the [CLEAR] operation.

[MENU] » [SET > Function > Quick RIT/ΔTX Clear]

① When the Tracking function is ON, the RIT function shifts the receive frequency on both the Main and Sub bands.

◇ RIT monitor function

When the RIT function is ON, you can directly monitor the operating frequency by holding down [XFC].

① While monitoring:

• The RIT function is temporarily turned OFF.

• The Noise Reduction, Notch filter, and Twin PBT settings are temporarily turned OFF.

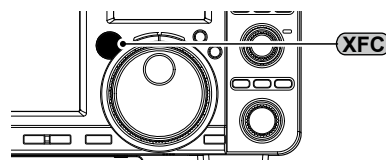

AGC function control

SSB, CW, RTTY, PSK, and AM modes

The Automatic Gain Control (AGC) function controls receiver gain to produce a constant audio output level, even when the received signal strength greatly varies.

① Each mode memorizes the AGC setting.

◇ Selecting the AGC time constant preset value

The transceiver has FAST, MID, and SLOW preset AGC settings for all modes, except in the FM mode.

1. Select the operating band and mode.
(Example: SSB, 14 MHz band)
2. Touch [AGC] to select the desired time constant.
① Touching [AGC] selects FAST, MID, or SLOW.
② For the FM mode, FAST is fixed.

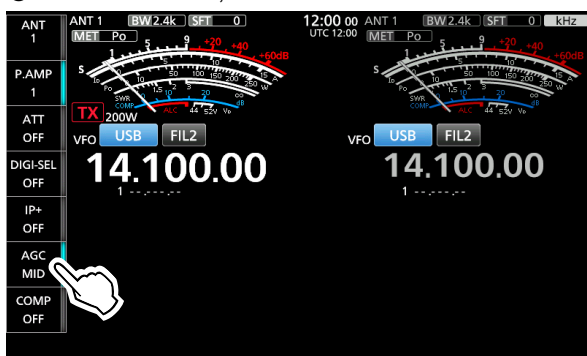

◇ Setting the AGC time constant

You can set the preset AGC time constant to a desired value.

1. Select the operating band and mode.
(Example: SSB, 14 MHz band)
2. Touch [AGC] for 1 second.



- Opens the AGC screen.
3. Touch FAST, MID, or SLOW. (Example: MID)
 4. Rotate (MAIN DIAL) to set the time constant.
① You can also select "OFF."

See the table described below on adjustable time constants.

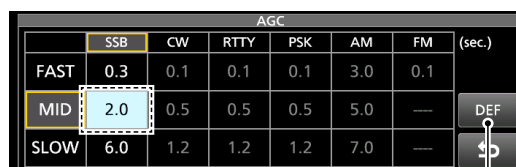

You can reset to the default setting by touching this key for 1 second.

5. To close the AGC screen, push [EXIT].

Selectable AGC Time constant (unit: seconds)

Mode	Default	Adjustable time constant
SSB	0.3 (FAST)	OFF, 0.1, 0.2, 0.3, 0.5, 0.8, 1.2, 1.6, 2.0, 2.5, 3.0, 4.0, 5.0, or 6.0
	2.0 (MID)	
	6.0 (SLOW)	
CW RTTY PSK	0.1 (FAST)	OFF, 0.1, 0.2, 0.3, 0.5, 0.8, 1.2, 1.6, 2.0, 2.5, 3.0, 4.0, 5.0, or 6.0
	0.5 (MID)	
	1.2 (SLOW)	
AM	3.0 (FAST)	OFF, 0.3, 0.5, 0.8, 1.2, 1.6, 2.0, 2.5, 3.0, 4.0, 5.0, 6.0, 7.0, or 8.0
	5.0 (MID)	
	7.0 (SLOW)	
FM	0.1 (FAST)	Fixed

NOTE: While you are receiving weak signals, and a strong signal is momentarily received, the AGC function quickly decreases the receiver gain. When that signal disappears, the transceiver may not receive weak signals because of the AGC action. In that case, select FAST, or touch [AGC] for 1 second to open the AGC screen, and then set the time constant to "OFF."

Setting the Speech Compressor

SSB mode

The Speech Compressor increases the average RF output power, improving readability at the receiving station. This function compresses the transmitter audio input to increase the average audio output level.

① The function is effective for long-distance communication, or when propagation conditions are poor.

◇ Setting before using the Speech Compressor function

1. Select the SSB mode. (Example: USB)
2. Be sure the Speech Compressor is OFF.
 - ① If it is ON, touch [COMP] to turn it OFF.

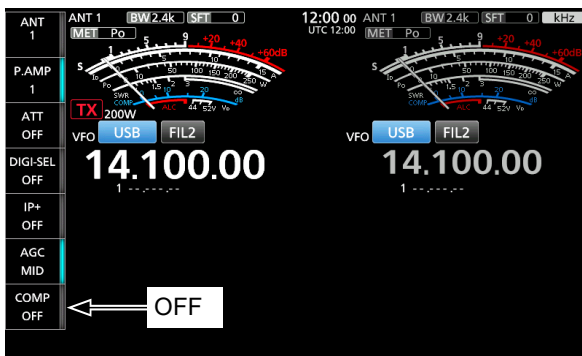

3. Touch the meter, and then touch [ALC] to display the ALC meter.



4. Push **[MULTI]** to open the Multi-function menu.
5. Touch [MIC GAIN], and then rotate **[MULTI]** to adjust it by speaking into the microphone to where the ALC meter reads within the 30 to 50% range of the ALC zone.



◇ Using the Speech Compressor function

1. Touch the meter, and then touch [COMP] to display the COMP meter.
2. Touch [COMP] for 1 second.
 - Turns ON the Speech Compressor function and opens the Multi-function menu.

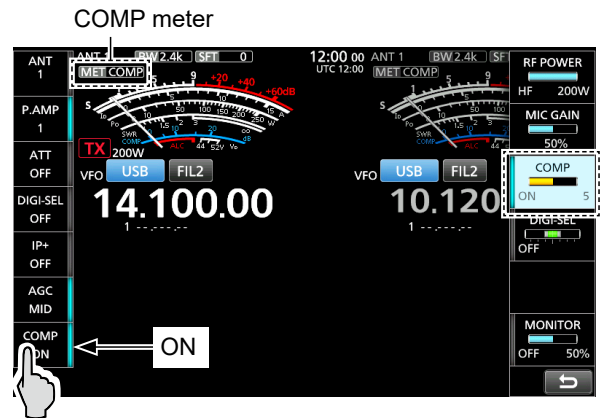

3. While speaking into the microphone at your normal voice level, rotate **[MULTI]** to adjust the Speech Compressor level to where the COMP meter reads within the COMP zone (10 to 20 dB range).
 - ① If the COMP meter peaks exceed the COMP zone, your transmitted voice may be distorted.

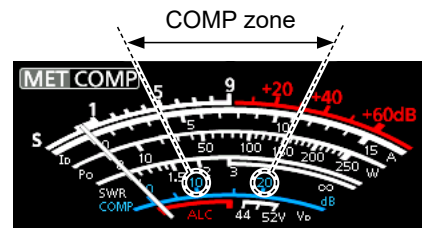

4. To close the Multi-function menu, push **[MULTI]**.

Using the Digital Twin PBT

SSB, CW, RTTY, PSK, and AM modes

To reject interference, the Digital Twin Passband Tuning (PBT) narrows the IF passband width by electronically shifting the IF frequency to slightly above or below the IF center frequency. The IC-7760 uses the digital function using the FPGA (Field Programmable Gate Array) filtering method.

① Each band memorizes the PBT setting.

● Rotate **TWIN PBT CLR** inner (PBT1) and outer (PBT2) to adjust the shift value.

• The passband width and shift value are displayed.



• The indicator to the left of **TWIN PBT CLR** lights white when you use the Digital Twin PBT to change the IF passband width.

① Hold down **TWIN PBT CLR** for 1 second to clear the PBT setting.

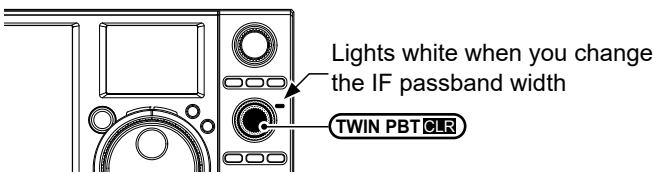

Information

- To narrow the IF passband width, shift “PBT1” and “PBT2” in the opposite direction from each other, to narrow the overlapped area.
- To use as the IF Shift function, set “PBT1” and “PBT2” to the same value.
- The PBT is adjustable in 50 Hz steps in the SSB, CW, RTTY, and PSK modes, and 200 Hz in the AM mode. The center shift value changes in 25 Hz steps in the SSB, CW, RTTY, and PSK modes, and 100 Hz in the AM mode.

NOTE: While rotating **TWIN PBT CLR**, you may hear some noise. This comes from the FPGA and does not indicate an equipment malfunction.

TIP:

- A dot “.” is displayed on the IF Filter indicator when you change the IF passband width, using the Digital Twin PBT.

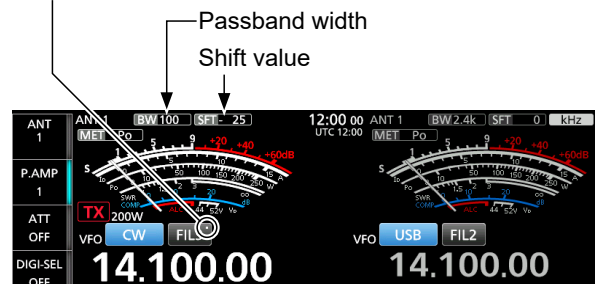

- Touch the IF Filter indicator for 1 second to display the current passband width and shift value. Opens the FILTER screen.

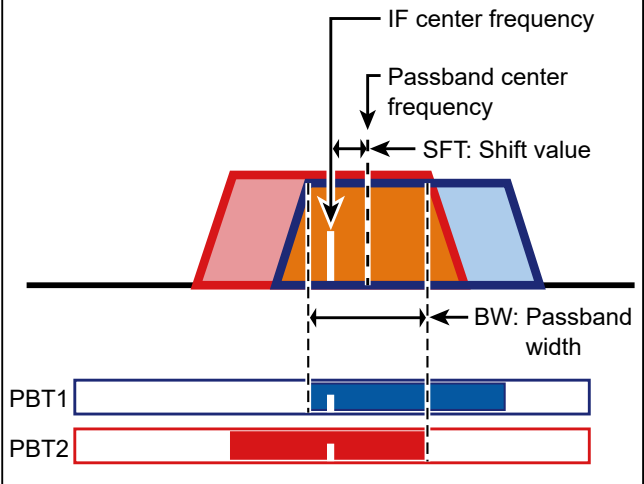
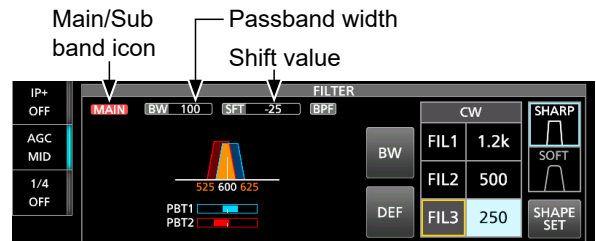

Using the Filter Effect screen

Displayed when you change the IF passband width.

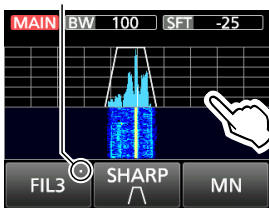

To display the keys, touch the screen.

Default value

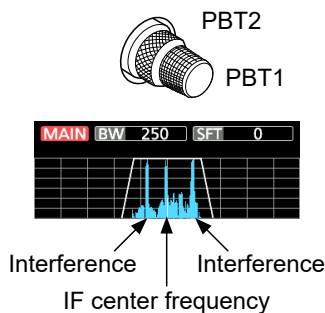

Cutting lower passband

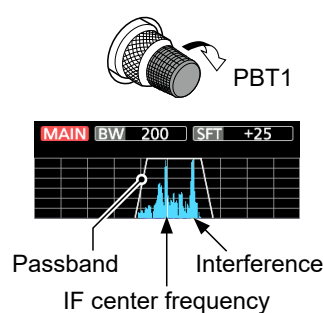

Cutting both higher and lower passbands

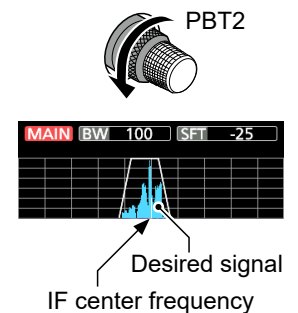

Selecting the IF filter

SSB, CW, RTTY, PSK, and AM modes

The IC-7760 has 3 IF filter passband widths for each mode, and you can select them on the FILTER screen.

You can set the IF filter to wide (FIL 1), mid (FIL 2), or narrow (FIL 3).

1. Select the operating mode. (Example: CW)
2. Touch the IF Filter indicator for 1 second.

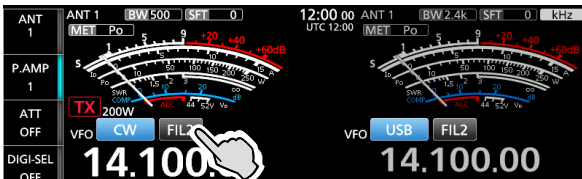

- Opens the FILTER screen.
3. Touch the IF Filter indicator several times to select FIL 1 (wide), FIL 2 (mid), or FIL 3 (narrow).
 4. Touch [BW].
 - Selects the passband width mode.

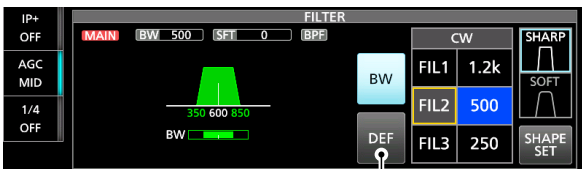

You can reset to the default settings by touching this key for 1 second.

5. Rotate **MAIN DIAL** to select the passband width.
 - ① You cannot change the passband width in the FM or FM-D mode.
 - ① When you change the passband width, the Digital Twin PBT setting value is reset to the center position.
 - ① "BPF" is displayed when a band width is set to 500 Hz or less in the SSB, CW, RTTY, or PSK mode.
6. To close the FILTER screen, push **EXIT**.

TIP: When you set the IF filter to FIL2 or FIL3 in the FM mode, the transceiver will transmit in the FM narrow mode.

Mode	IF filter	Selectable range (steps)
SSB	FIL 1 (3.0 kHz)	50 Hz to 500 Hz (50 Hz)/ 600 Hz to 3.6 kHz (100 Hz)
	FIL 2 (2.4 kHz)	
	FIL 3 (1.8 kHz)	
SSB-D	FIL 1 (3.0 kHz)	50 Hz to 500 Hz (50 Hz)/ 600 Hz to 3.6 kHz (100 Hz)
	FIL 2 (1.2 kHz)	
	FIL 3 (500 Hz)	
CW PSK	FIL 1 (1.2 kHz)	50 Hz to 500 Hz (50 Hz)/ 600 Hz to 3.6 kHz (100 Hz)
	FIL 2 (500 Hz)	
	FIL 3 (250 Hz)	
RTTY	FIL 1 (2.4 kHz)	50 Hz to 500 Hz (50 Hz) 600 Hz to 2.7 kHz (100 Hz)
	FIL 2 (500 Hz)	
	FIL 3 (250 Hz)	
AM AM-D	FIL 1 (9.0 kHz)	200 Hz to 10.0 kHz (200 Hz)
	FIL 2 (6.0 kHz)	
	FIL 3 (3.0 kHz)	
FM FM-D	FIL 1 (15 kHz)	Fixed
	FIL 2 (10 kHz)	
	FIL 3 (7.0 kHz)	

Selecting the IF filter shape

SSB and CW modes

You can set the IF filter shape for each mode.

1. Select the operating mode. (Example: CW)
2. Touch the filter icon for 1 second.
 - Opens the FILTER screen.
3. Touch [SHARP] or [SOFT].

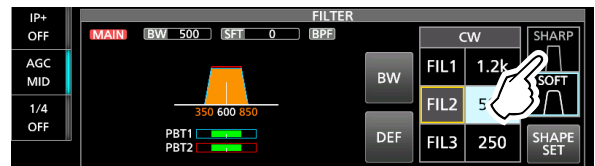

① Touching [SHAPE SET] opens the FILTER SHAPE SET screen.

4. To close the FILTER screen, push **EXIT**.

• SHARP

This selection is to emphasize the passband width of the filter. The filter has an almost ideal shape factor. Signals that are out of the passband are extremely filtered out, and it gives you better audio quality.

• SOFT

The filter shoulders are roundly formed as in analog filters. This decreases noise components in the high and low frequencies of the filter passband, and increases the S/N of the target signal. These characteristics play an effective role in picking up very weak signals. The shape factor is retained, and the sharpness of the bandpass is excellent.

Notch Filter

The IC-7760 has Auto Notch and Manual Notch functions.

Auto Notch automatically attenuates beat tones, tuning signals, and so on. It can be used in the SSB, AM, and FM modes.

Manual Notch attenuates beat tones, tuning signals, and so on by manually adjusting the filtering frequency. It can be used in the SSB, CW, RTTY, PSK, and AM modes.

◇ Selecting the Notch filter type

- Push **[NOTCH]**.

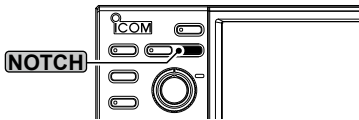

- The Notch Filter indicator on **[NOTCH]** lights.
- ① Pushing **[NOTCH]** changes between “AN (Auto Notch),” “MN (Manual Notch),” and OFF.
- ① You can also select the Notch filter type on the **FUNCTION** screen.



Displayed when Auto Notch is selected.

◇ Setting the Manual Notch filter

When Manual Notch is selected, adjust the filtered frequency.

1. Hold down **[NOTCH]** for 1 second.
 - Opens the NOTCH menu.
 - The Manual Notch is automatically selected, and “MN” is displayed.
2. Touch **[WIDTH]** several times to set the Manual Notch filter width to “WIDE,” “MID,” or “NAR.”

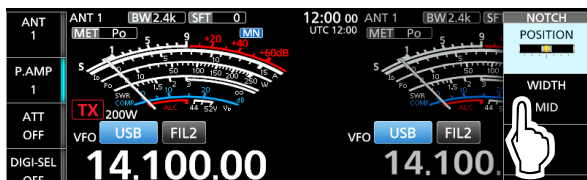

3. Rotate **[MULTI]** slowly, to manually attenuate the frequency.
4. To close the NOTCH menu, push **[MULTI]**.

NOTE: While adjusting, noise may be heard. This comes from the FPGA and does not indicate an equipment malfunction.

◇ Using the Filter Effect screen

When Manual Notch is selected, you can visually check that the Notch function removes the set frequency and filter width from the signal.

When the Notch function is OFF

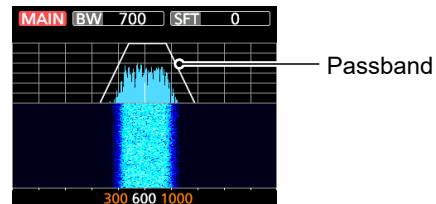

Passband

When the Notch function is ON

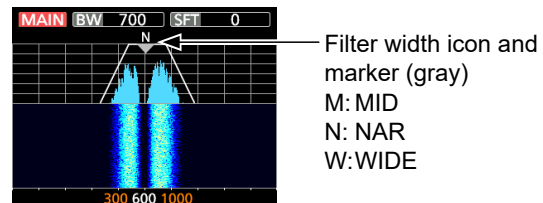

Filter width icon and marker (gray)
M: MID
N: NAR
W: WIDE

While adjusting the filtered frequency

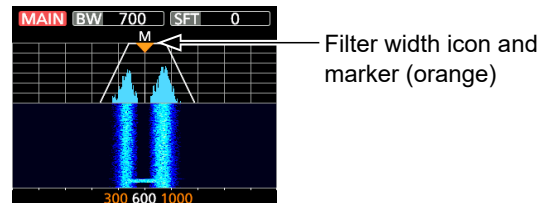

Filter width icon and marker (orange)

- ① When the marker moves outside the upper or lower Edge frequency, “<<” or “>>” is displayed in the upper side corners of the Filter Effect screen.

<<: The marker is outside the lower edge.
>>: The marker is outside the higher edge.

TIP: Touching the Sub screen displays the function keys.

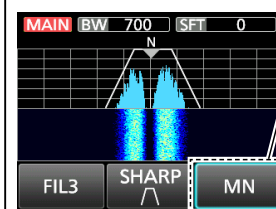

- Touching **[MN]** changes between “MN (Manual Notch)” and OFF.
- Touching **[MN]** for 1 second opens the NOTCH menu.

Noise Blanker

SSB, CW, RTTY, PSK, and AM modes

The Noise Blanker eliminates pulse-type noise, such as the noise from car ignitions.

- Push **NB**.
 - The Noise Blanker indicator on **NB** lights.
 - ① Pushing **NB** turns this function ON or OFF.
 - ① You can also turn the Noise Blanker ON or OFF on the FUNCTION screen.

NOTE: When using the Noise Blanker, received signals may be distorted if they are excessively strong, or the noise is other than a pulse type. In that case, turn OFF the Noise Blanker, or shallow the DEPTH on the NB menu. See the description below for details.

◇ Adjusting the NB level and time

To deal with various types of noise, you can adjust the attenuation level and blanking depth and width in the NB menu.

1. Hold down **NB** for 1 second.
 - Turns ON the Noise Blanker and opens the NB menu.
2. Touch the item to adjust. (Example: DEPTH)



3. Rotate **MULTI** to adjust the item. (Example: 8)
4. To close the NB menu, push **MULTI**.

LEVEL (Default: 50%)

Adjusts the level where the Noise Blanker activates between 0 and 100%.

DEPTH (Default: 8)

Adjusts the noise attenuation level to between 1 and 10.

WIDTH (Default: 50)

Adjusts the blanking duration time to between 1 and 100.

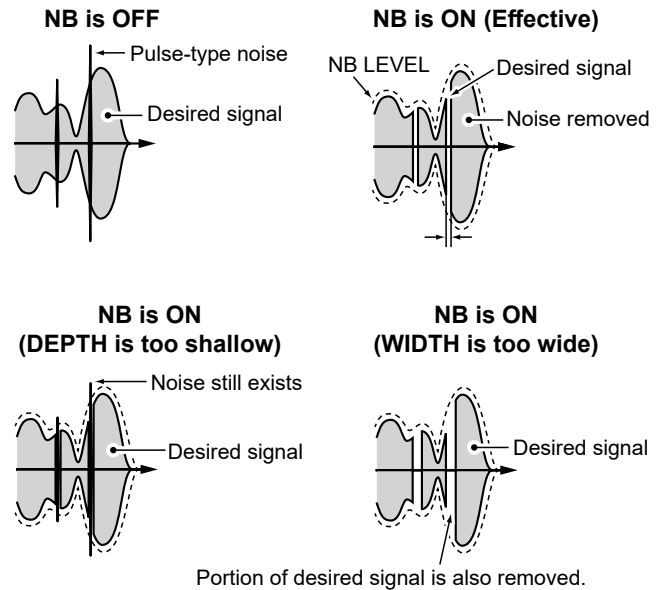

Noise Reduction

The Noise Reduction function reduces random noise components and enhances signal audio.

- Push **NR**.
 - The Noise Reduction indicator on **NR** lights.
 - ① Pushing **NR** turns this function ON or OFF.
 - ① You can also turn the Noise Reduction ON or OFF on the FUNCTION screen.

◇ Adjusting the Noise Reduction level

Adjust the Noise Reduction level to where noise is reduced but the received signal is not distorted.

1. Hold down **NR** for 1 second.
 - Turns ON the Noise Reduction function and opens the NR menu.
2. Rotate **MULTI** to adjust the Noise Reduction level to between 0 and 15.

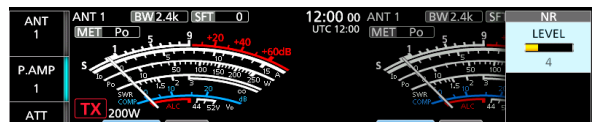

- ① Adjust to a higher level to increase the reduction level, and a lower level to decrease it.
3. To close the NR menu, push **MULTI**.

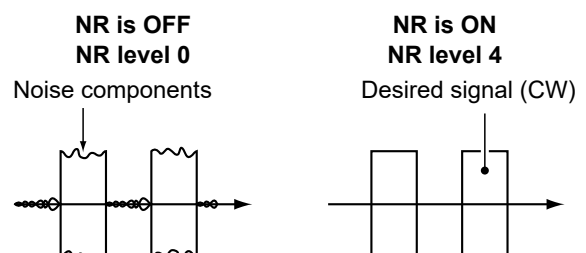

Setting the transmit filter width

SSB mode

The transmit filter width for the SSB and SSB-D modes can be set. WIDE (wide), MID (mid), or NAR (narrow) can be selected only in the SSB mode.

① The filter settings are memorized for both the ON and OFF states of the Compressor function.

To change the filter width in the SSB mode:

1. Set the operating mode to USB or LSB.
2. Push **[FUNCTION]**.
 - Opens the FUNCTION screen.
3. Touch [TBW].

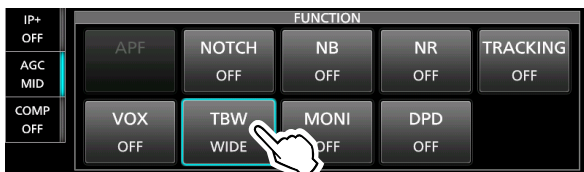

① Touching [TBW] changes the filter width between WIDE, MID, and NAR.

The transmit filter widths are set to the following values by default.

- SSB (WIDE): 100 Hz to 2900 Hz
- SSB (MID): 300 Hz to 2700 Hz
- SSB (NAR): 500 Hz to 2500 Hz
- SSB-D: 300 Hz to 2700 Hz

① You can change the filter width values in the following settings.

- [MENU]** » SET > Tone Control/TBW > TX > SSB > **TBW (WIDE)**
- [MENU]** » SET > Tone Control/TBW > TX > SSB > **TBW (MID)**
- [MENU]** » SET > Tone Control/TBW > TX > SSB > **TBW (NAR)**
- [MENU]** » SET > Tone Control/TBW > TX > SSB-D > **TBW**

Monitor function

SSB, RTTY, PSK, AM, and FM modes

The Monitor function enables you to monitor your transmit audio. Use this function to check the voice characteristics while adjusting transmit audio parameters.

① You can hear the CW sidetone regardless of the Monitor function setting.

1. Select the operating mode that you want to monitor. (Example: SSB)
2. Push **[FUNCTION]**.
 - Opens the FUNCTION screen.
3. Touch [MONI] to turn ON the Monitor function.

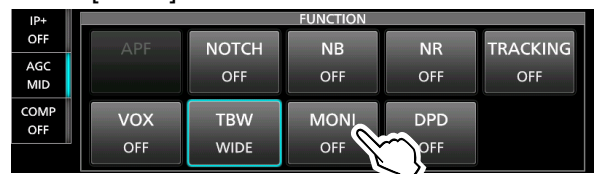

① Touching [MONI] turns the Monitor function ON or OFF.

4. If you want to adjust the monitor audio output, touch [MONI] for 1 second.

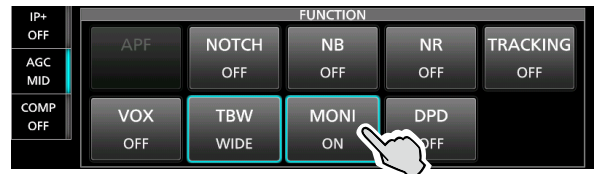

5. Rotate **[MULTI]** to adjust MONITOR to the clearest audio output between 0% and 100%, while speaking at your normal voice level.



6. To close the Multi-function menu, push **[MULTI]**.

NOTE: When using the VOX function, turn OFF the Monitor function. Otherwise, the transmitted audio will echo.

DPD function

SSB and AM modes

The Digital Pre-Distortion (DPD) function reduces the distortion of the SSB, SSB-D, AM, or AM-D mode signals transmitted by the transceiver.

When the transceiver is used as an exciter for the IC-PW2, the distortion generated by the RF power amplifier is also reduced.

There are 2 ways to use the DPD function.

Use the DPD function only with the transceiver:

The DPD single adjustment* (Adjustment only with the transceiver) is made at the factory. The DPD function can be used without the adjustment.

* By adjusting the ALC circuit voltage and gain in the FPGA, sudden changes in the gain of the ALC circuit behind the FPGA can be minimized, enabling optimal distortion correction.

- ① This also applies when the IC-PW2 is connected, but the linear amplifier circuit is OFF.
- ① When the linked adjustment cannot be performed, make the single adjustment. See the Advanced manual for details.

Use when operating the transceiver as an exciter for the IC-PW2:

The DPD linked adjustment (Adjustment linked with the IC-PW2) for each operating band is required.

- ① See the Advanced manual for details.

◇ Turning the DPD function ON or OFF

1. Select the operating mode. (Example: USB)
2. Push **FUNCTION**.
3. Touch [DPD].

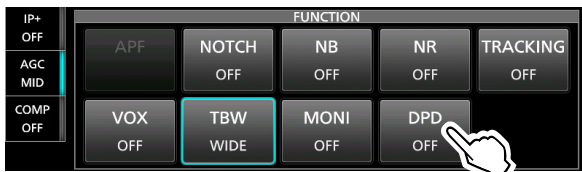

- ① Touching [DPD] turns the DPD function ON or OFF.

Digital Selector

You can manually adjust the center frequency of the automatic preselector using the Digital Selector function.

The automatic preselector adds to reduce intermodulation distortion from nearby strong signals. The automatic preselector tracks the frequency tuning by changing its resonant frequency in discrete steps. The function is used for only 1.500000 MHz ~ 29.999999 MHz.

- ① Each band memorizes the Digital Selector function setting.
- ① When the Digital Selector function is ON, the circuit configuration differs, depending on the setting of the receive preamplifier.
 - When the preamplifier is set to "OFF":
A filter is inserted in the first stage, where high-frequency frequencies pass through, to get the full filtering effect.
 - When the preamplifier is set to "P.AMP 1" or "P.AMP 2":
A filter is inserted after the preamplifier, to filter without loss of sensitivity.
- Touch [DIGI-SEL].
 - ① Touching [DIGI-SEL] turns the Digital Selector function ON or OFF.

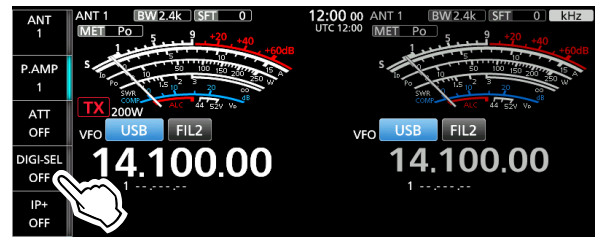

◇ Adjusting the center frequency

1. Touch [DIGI-SEL] for 1 second.
 - Opens the Multi-function menu.

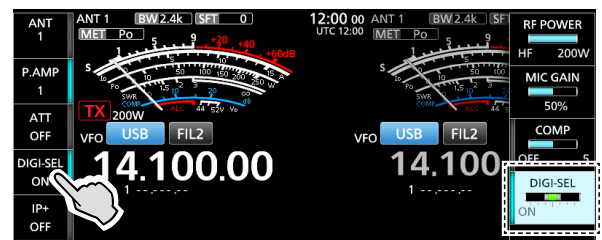

2. Rotate **(MULTI)** to adjust the center frequency.
3. To close the Multi-function menu, push **(MULTI)**.

NOTE:

- The Digital Selector function is automatically turned OFF while scanning.
- When you rotate **(MAIN DIAL)** while the Digital Selector is ON, mechanical noise may be heard due to the switching noise from internal relays.

Split frequency operation

Split frequency operation enables you to transmit and receive on different frequencies on the Main and the Sub bands.

There are 2 ways to use Split frequency operation.

- Use the Quick Split function.
- Use the receive and transmit frequencies set to the Main and Sub bands.

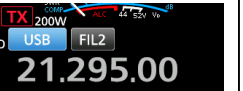
The other station		Your station	
Transmit frequency	USB mode 21.29000 MHz	Main band Receive frequency	
Receive frequency	USB mode 21.29500 MHz	Sub band Transmit frequency	

◇ Using the Quick Split function

The Quick Split function enables you to automatically equalize the frequency and mode of the Main band to the Sub band, and activate the Split function.

1. Set the Main band's receive frequency and operating mode.
(Example: 21.29000 MHz in the USB mode)
2. Hold down **[SPLIT]** for 1 second.
 - The Quick Split function is turned ON, and the Main band settings are set to Sub band.

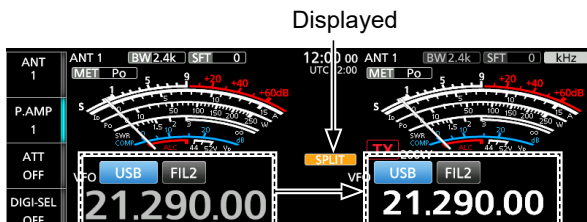

3. Rotate **[MAIN DIAL]** to set the Sub band's transmit frequency.
(Example: 21.29500 MHz in the USB mode)

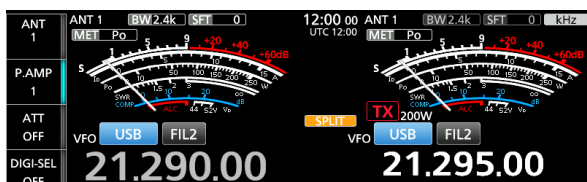

◇ Using the receive and transmit frequencies set to Main and Sub bands

1. Set the Main band's receive frequency and operating mode.
(Example: 21.29000 MHz in the USB mode)
2. Touch the Sub band's frequency readout to select the Sub band, and then set the receive frequency and the operating mode.
(Example: 21.29500 MHz in the USB mode)



3. Push **[SPLIT]**.
 - ① Pushing **[SPLIT]** turns the Split function ON or OFF.

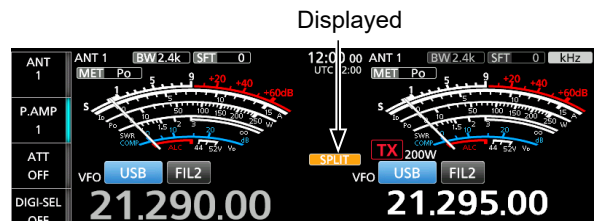

4. Touch the Main band's frequency readout to return to receive on the Main band.
 - ① The Split frequency operation is ready.

TIP: You can select whether or not to display the F-INP screen when turning ON the Quick Split function.

[MENU] » SET > Function > SPLIT > Display Keypad on Quick SPLIT

Split Lock function

To prevent accidentally changing the receive frequency by releasing (XFC) while rotating (MAIN DIAL), use the Split Lock function. Using both this function and the Dial Lock function enables you to change only the transmit frequency.

1. Turn ON the Split Lock function.
 [MENU] » [SET > Function > SPLIT > SPLIT LOCK]
2. Turn ON the Split function.
3. Hold down [SPEECH] for 1 second to turn ON the Dial Lock function.
4. While holding down (XFC), set the transmit frequency.

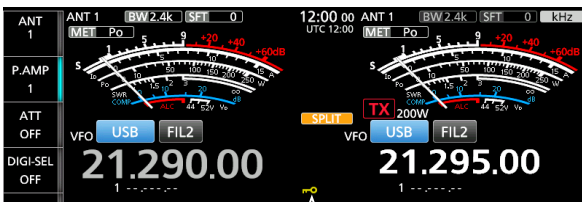

Displayed when the Dial Lock function is ON.

Auto Tuning function

CW and AM modes

You can tune in a signal you are receiving using the Auto Tuning function. You can automatically tune the signal in the IF passband width in the CW mode, or within a ± 5 kHz range in the AM mode.

1. Select the AM or CW mode.
2. Push [AUTOTUNE] to start the Auto Tuning.
 Ⓛ While using the RIT function, the RIT frequency is automatically tuned by this function.



Displayed while tuning

NOTE: When receiving a weak signal, or receiving a signal with interference, the Auto Tuning function may tune the receiver to an undesired signal, or may not start to tune. In such case, a warning beep sounds.

Operating CW

◇ Setting the CW pitch control

You can set the received CW audio pitch and the CW side tone to suit your preference, without changing the operating frequency.

1. Select the CW mode.
2. Push [MULTI] to open the Multi-function menu.
3. Touch [CW PITCH].



4. Rotate [MULTI] to set the CW pitch to between 300 and 900 Hz (in 5 Hz steps).
5. To close the Multi-function menu, push [MULTI].

TIP: To graphically display the CW pitch, open the FILTER screen by touching the IF Filter indicator for 1 second.

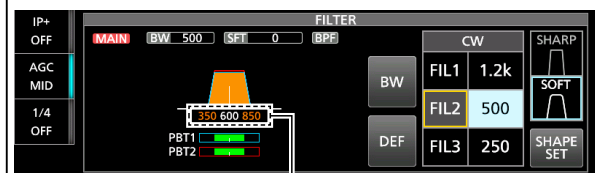

CW pitch frequency

When the selected IF filter is:

- Below 500 Hz, the CW pitch frequency is graphically changed in 5 Hz steps.
- Above 600 Hz, the CW pitch frequency is graphically changed in 25 Hz steps.

◇ Setting the key speed

You can set the keying speed of the internal electronic keyer.

1. Select the CW mode.
2. Push [MULTI] to open the Multi-function menu.
3. Touch [KEY SPEED].

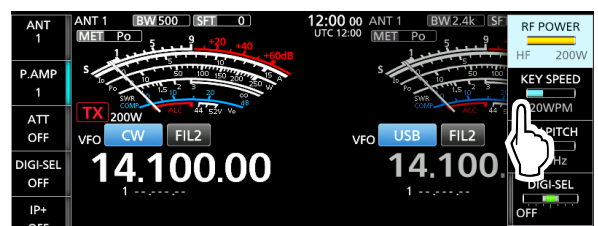

4. Rotate [MULTI] to set the key speed to between 6 and 48 Words Per Minute (WPM).
5. To close the Multi-function menu, push [MULTI].

Operating CW

◇ Using the Break-in function

Use the Break-in function in the CW mode to automatically switch between transmit and receive when keying. The IC-7760 is capable of operating in the Semi Break-in and Full break-in modes.

TIP: “Key Type” is set to “Paddle” by default. You can select the keyer type in the following item.

MENU » **SET > CW-KEY SET > Key Type**

Semi Break-in operation

In the Semi Break-in mode, the transceiver transmits when keying, and then automatically returns to receive after a preset time after you stop keying.

1. Select the CW mode.
2. Push **VOX/BK-IN** several times to select “BKIN.”

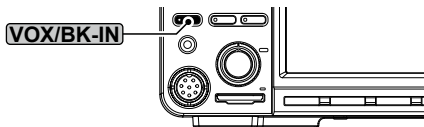

- The “BKIN” icon is displayed, and the BK-IN indicator on **VOX/BK-IN** lights.
 - ① Pushing **VOX/BK-IN** selects “BKIN (Semi Break-in),” “F-BKIN (Full Break-in),” or OFF (no indication).
3. To adjust the Break-in delay time, hold down **VOX/BK-IN** for 1 second.
 - Opens the BKIN menu.
 4. Rotate **ⓂMULTI** to set to where the transceiver returns to receive after the desired delay time after you stop keying.

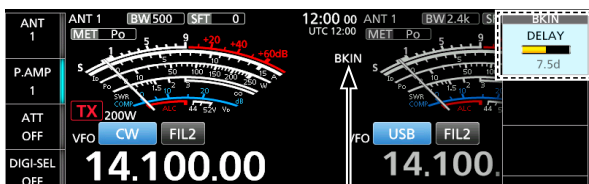

The selected mode (Semi Break-in) is displayed.

- ① When using a paddle, push **ⓂMULTI** to open the Multi-function menu, and then adjust the KEY SPEED (p. 4-11) while operating the paddle.
5. To close the BKIN menu, push **ⓂMULTI**.

Full Break-in operation

In the Full Break-in mode, the transceiver automatically transmits while keying down, and then immediately returns to receive after keying up.

1. Select the CW mode.
2. Push **VOX/BK-IN** several times to display “F-BKIN.”
 - The “F-BKIN” icon is displayed, and the BK-IN indicator on **VOX/BK-IN** lights.
 - ① Pushing **VOX/BK-IN** selects “BKIN (Semi Break-in),” “F-BKIN (Full Break-in),” or OFF (no indication).



The selected mode (Full Break-in) is displayed.

3. Use a straight key or paddle.
 - ① In the Full break-in mode, the transceiver automatically returns to receive immediately after you key up. The transceiver receives while keying up.

◇ Monitoring the CW side tone

When the transceiver is in standby and the Break-in function is OFF, you can listen to the CW side tone without actually transmitting.

① Information

- This enables you to match your transmit frequency exactly to another station’s by matching the audio tone.
- You can also use the CW side tone (make sure the Break-in function is OFF) to practice CW sending.
- You can adjust the CW side tone level in the following item.

MENU » **SET > CW-KEY SET > Side Tone Level**

Operating CW

◇ Audio Peak Filter (APF) operation

The APF enables you to set excellent selectivity in the CW mode. You can set the selectivity to between the 3 APF passband widths.

1. Select the CW mode.
2. Push **[APF/TPF]** to turn ON the Audio Peak Filter.

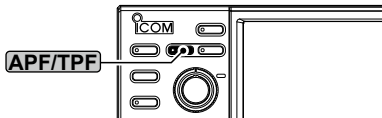

- The APF icon is displayed, and the APF indicator on **[APF/TPF]** lights.
 - The selected passband width is displayed under the APF icon for 1 second.
- ① Pushing **[APF/TPF]** turns the function ON or OFF.
 - ① You can also turn the function ON or OFF on the **FUNCTION** screen.
3. Hold down **[APF/TPF]** for 1 second.
 - Opens the APF menu.

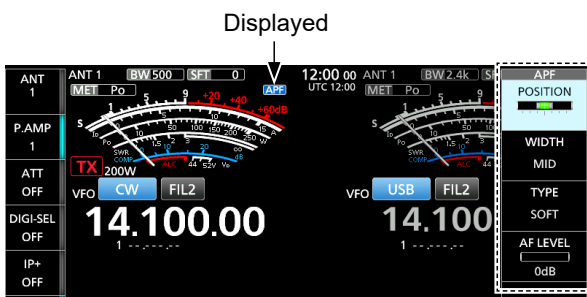

4. Touch to select the item, and then set the audio filter position, passband width, and the audio level.
5. To close the APF menu, push **[MULTI]**.

POSITION

Shifts the peak frequency of the APF. This function enables you to avoid interference from adjacent frequencies.

WIDTH (Default: WIDE)

Selects the APF passband width.

- When "TYPE" is set to "SOFT," select WIDE, MID, or NAR.
- When "TYPE" is set to "SHARP," select 320 Hz, 160 Hz, or 80 Hz.

TYPE (Default: SOFT)

Selects the audio filter type (soft sound or sharp sound).

AF LEVEL (Default: 0 dB)

Sets the audio level between 0 dB and +6 dB in 1 dB steps.

◇ About the electronic Keyer function

You can set the Memory Keyer function settings, paddle polarity settings, and so on of the Electronic Keyer.

1. Select the CW mode.
2. Open the **KEYER SEND** screen.

[MENU] » **[KEYER]**

3. Touch **[EDIT/SET]**.

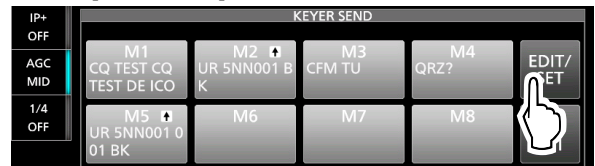

- Opens the **EDIT/SET** screen.
4. Select the desired item to set.

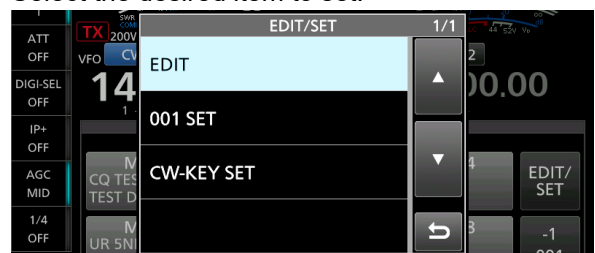
• **EDIT:**

Opens the **KEYER MEMORY** edit menu, and you can edit the Keyer memories M1 to M8.

• **001 SET:**

Opens the **KEYER 001** Contest Number menu, and you can set the following items.

- Number Style
- Count Up Trigger
- Present Number

• **CW-KEY SET:**

Opens the **CW-KEY SET** menu, and you can set the following items.

- Side Tone Level
- Side Tone Level Limit
- Keyer Repeat Time
- Dot/Dash Ratio
- Rise Time
- Paddle Polarity
- Key Type
- MIC Up/Down Keyer

① You can also set the same items in the **Set** mode.

[MENU] » **[SET > CW-KEY SET]**

5. To close the **KEYER SEND** screen, push **[EXIT]** several times.

Spectrum scope screen

The spectrum scope enables you to display the activity on the selected band, as well as the relative strengths of various signals in that band.

The transceiver has three spectrum scope modes, the Center mode, the Fixed mode, and the Scroll mode. You can also turn the Waterfall display ON or OFF. In addition, you can select the Mini scope to display the scope in a smaller size on the screen.

Center mode screen

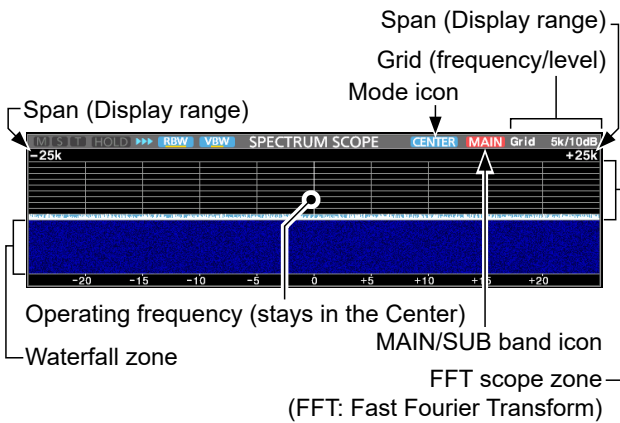

Fixed mode screen

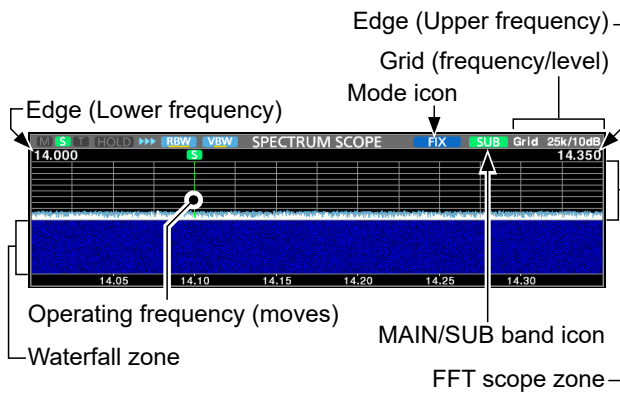

Scroll mode screen

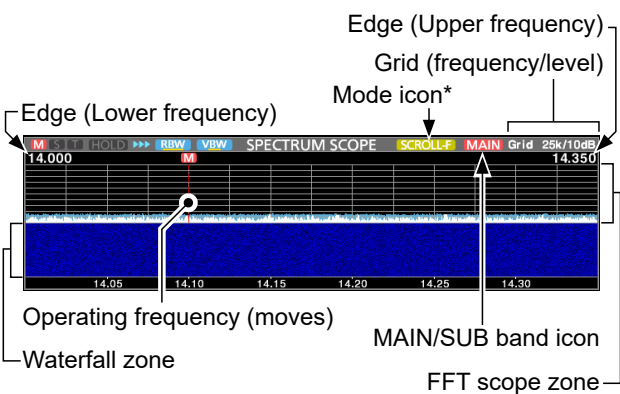

* When in the SCROLL-C mode, **SCROLL-C** is displayed.

Using the Spectrum Scope

Display the SPECTRUM SCOPE screen.

MENU » **SCOPE**

MENU 1: Center/Scroll-C mode

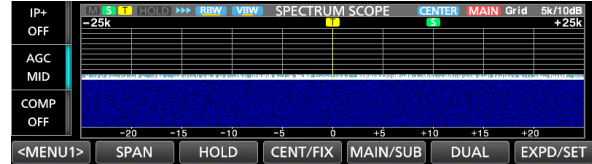

MENU 1: Fix/Scroll-F mode



MENU 2: Center/Fix/Scroll-C/Scroll-F mode



Key	Action	
<MENU1> <MENU2>	Selects the Function menus.	
SPAN	Touch	In the Center or Scroll-C mode, selects the scope span. • Spans: $\pm 2.5, 5.0, 10, 25, 50, 100, 250,$ and 500 kHz
	Touch for 1 second	Resets to the ± 2.5 kHz span.
EDGE	In the Fixed or Scroll-F mode, selects the Edge frequencies. ① You can set the upper and lower Edge frequencies in "Fixed Edges" on the SCOPE SET screen by touching [EXPD/SET] for 1 second.	
HOLD	Touch	Turns the Hold function ON or OFF. • [HOLD] and the Marker are displayed. Freezes the current spectrum.
	Touch for 1 second	Clears the Peak Hold level.
CENT/FIX	Touch	Selects the Center or Fixed mode.
	Touch for 1 second	Selects the Scroll mode.
MAIN/SUB	Selects the Main or Sub band.	
DUAL	Selects the Dual or Single scope.	
EXPD/SET	Touch	Selects the Expanded or Normal screen.
	Touch for 1 second	Displays the SCOPE SET screen. ① See the Advanced manual for details.
REF	Opens the "REF Level" window. ① Rotate (MAIN DIAL) to adjust the Reference level. ① Touch again to close the window.	
SPEED	Selects the sweep speed. • "▶▶▶" (FAST), "▶▶" (MID), or "▶" (SLOW).	
RBW	Selects the Resolution Band Width from NAR (narrow), MID, and WIDE. ① This selection is for the filter that visually separates the spectrum. ① When "NAR" is selected, the signals are finely separated.	
VBW	Selects the Video Band Width from NAR (narrow) and WIDE. ① When "Wide" is selected, the line drawn on the receive spectrum becomes wide. However, the small edge cannot be drawn.	
MARKER	Selects various Markers.	

Spectrum scope screen

◇ Marker

The Marker displays the operating frequency for both the Main and Sub bands in the SPECTRUM SCOPE screen.

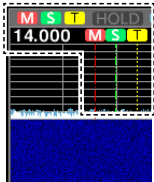

- M:** The Main band marker
 - Marks the Main band frequency.
- S:** The Sub band marker
 - Marks the Sub band frequency.
- T:** The TX marker
 - Marks the transmit frequency.

• About Main and Sub Marker

In the Fixed or Scroll mode, the Main and Sub band Marker displays the operating frequency within a specified frequency range. So, the transceiver always displays the Main or Sub band marker in the Scope screen.

In the Center mode, the operating frequency stays in the center of the screen. Thus, the transceiver does not display either the Main band marker on the Main scope, or the Sub band marker on the Sub scope.

① When the Hold function is ON, the RX Marker is displayed to indicate the operating frequency's location.

◇ Mini scope screen

The Mini scope screen can be simultaneously displayed with another function displays, such as the RTTY DECODE screen and the AUDIO SCOPE screen or the FUNCTION screen.

Push **[M.SCOPE]** to turn the Mini scope screen ON or OFF.

① Hold down **[M.SCOPE]** for 1 second to display the SPECTRUM SCOPE screen.

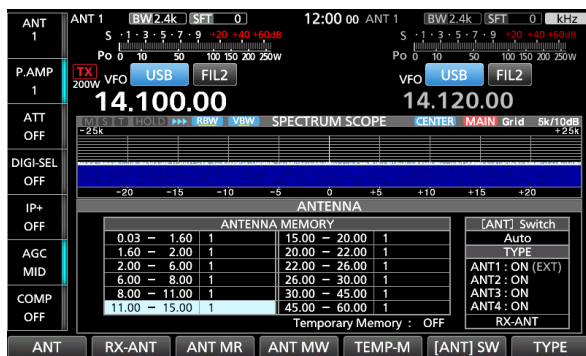

Example: Displaying the Mini scope screen while the ANTENNA screen is displayed.

Audio scope screen

This audio scope enables you to display the received signal's frequency component on the FFT scope, and its waveform components on the Oscilloscope. The FFT scope also has a waterfall.

• AUDIO SCOPE screen

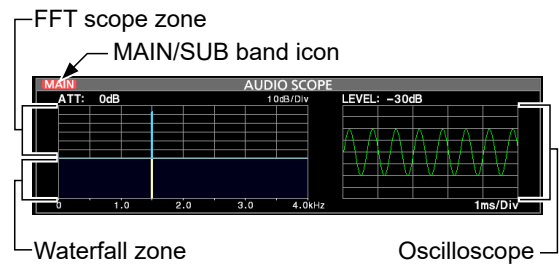

◇ Using the Audio Scope

Display the AUDIO SCOPE screen.

[MENU] » **AUDIO**

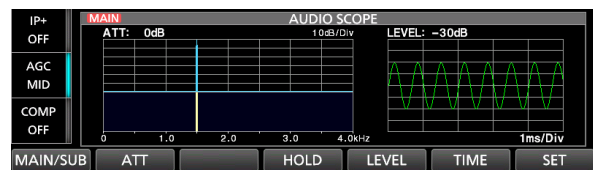

Key	Action	
MAIN/SUB	Selects the Main or Sub band.	
ATT	Touch	Selects the attenuator for the FFT scope. <ul style="list-style-type: none"> • 0 (OFF), 10, 20, or 30 dB
	Touch for 1 second	Turns OFF the attenuator. (0 dB)
HOLD	Turns the Hold function ON or OFF. <ul style="list-style-type: none"> • [HOLD] is displayed and freezes the current audio spectrum. 	
LEVEL	Selects the Oscilloscope level. <ul style="list-style-type: none"> • 0, -10, -20, or -30 dB 	
TIME	Selects the Oscilloscope sweep time. <ul style="list-style-type: none"> • 1, 3, 10, 30, 100, or 300 ms/Div 	
SET	Displays the AUDIO SCOPE SET screen. <ul style="list-style-type: none"> ① See the Advanced manual for details. 	

The SD cards, SDHC cards, and USB flash drive are user supplied.

TIP: Icom recommends that you save the transceiver's factory default data for backup.

About the SD cards

You can use an SD card of up to 2 GB, or an SDHC of up to 32 GB. Icom has checked the compatibility of the following cards.

(As of October 2024)

Brand	Type	Memory size
SanDisk®	SD	2 GB
	SDHC	4/8/16/32 GB

- ① The above list does not guarantee the card's performance.
- ① Throughout the rest of this document, the SD cards and SDHC cards are simply called the SD card or the card.

About the USB flash drive

Use the USB flash drive that supports the interface 1.1 or 2.0.

- ① These do not guarantee the USB flash drive's performance.
- ① Throughout the rest of this document, the USB flash drives are called the USB flash drive or the flash drive.

NOTE:

- Before using the SD card or USB flash drive, thoroughly read their instructions.
- If any of the following occur, the card's or flash drive's data may be corrupted or deleted.
 - You remove the card or flash drive from the transceiver while it is still accessing the card.
 - A power failure occurs, or the power cable is disconnected, while accessing the card.
 - You drop, impact, or vibrate the card or flash drive.
- **DO NOT** touch the contacts of the card or flash drive.
- The transceiver may take a longer time to recognize a high capacity card or flash drive.
- The card or flash drive has a certain lifetime, so data reading or writing may not be possible after using it for a long period of time. In that case, use a new one. We recommend that you make a backup of the data onto another device.
- Icom will not be responsible for any damage caused by data corruption on a card or flash drive.
- If you transfer or dispose of your SD card or USB flash drive, first completely delete its data to avoid leaking.

Saving data

You can save the following data onto the card or USB flash drive.

SD Card

- The transceiver's settings
- Communication/receive log and contents
- Voice audio for the Voice TX function
- RTTY and PSK decode log
- Captured screens

USB flash drive

- The transceiver's settings
- Captured screens

Inserting

Insert the SD card or USB flash drive as shown below.

- ① Insert the SD card into the slot until it locks in place, and makes a 'click' sound.
- ① Be sure to check the card or flash drive orientation before inserting.

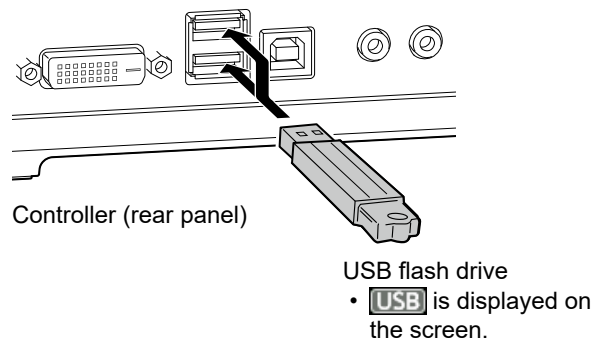
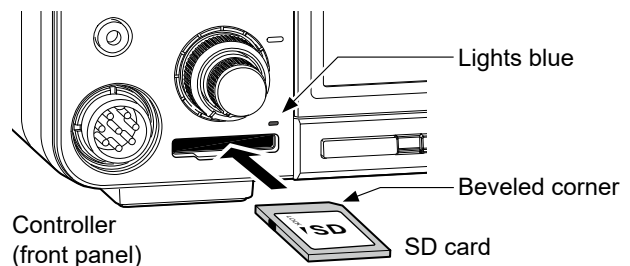

NOTE:

Before using an SD card or USB flash drive for the first time, format it in the transceiver.

- Formatting a card or flash drive erases all its data. Before formatting any used card or flash drive, back up its data onto another device.
- After inserting or formatting, a special folder on the card or flash drive that you need for operations like updating the firmware is created on the card or flash drive.

IMPORTANT: Even if you have formatted an SD card or flash drive, some data may remain in it. When you dispose the card or flash drive, be sure to physically destroy it to avoid unauthorized access to any data that remains.

Formatting

Before using an SD card or USB flash drive, format it to be used with the transceiver by doing the following steps.

1. Open the SD CARD or USB FLASH DRIVE screen.

MENU » **SET > SD Card**

MENU » **SET > USB Flash Drive**

2. Touch "Format." (Example: SD CARD)

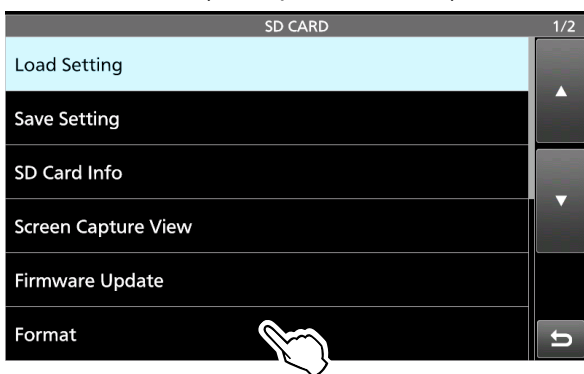

3. Touch [YES] to start formatting.

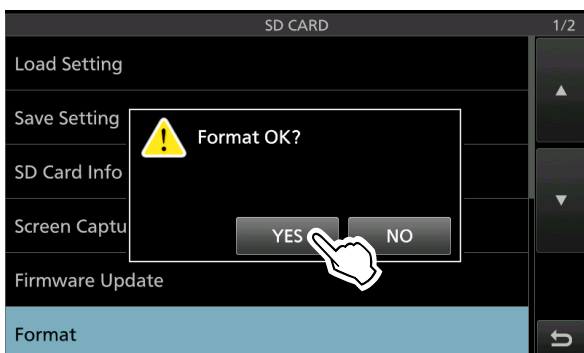

- After formatting, returns to the SD CARD or USB FLASH DRIVE screen.

① To cancel formatting, touch [NO].

4. To close the SD CARD or USB FLASH DRIVE screen, push **EXIT** several times.

Unmounting

Before you remove a card when the transceiver is ON, be sure to electrically unmount it, as shown below. Otherwise, the data may be corrupted or deleted.

1. Open the SD CARD or USB FLASH DRIVE screen.

MENU » **SET > SD Card**

MENU » **SET > USB Flash Drive**

2. Touch "Unmount." (Example: SD CARD)

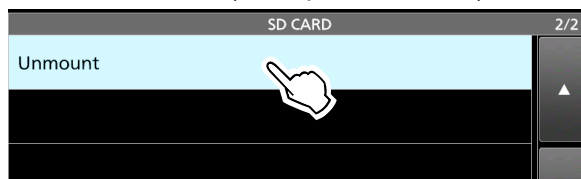

3. Touch [YES] to unmount.

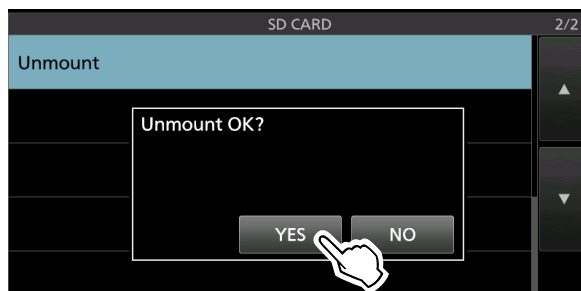

- After unmounting, returns to the SD CARD or USB FLASH DRIVE screen.

① To cancel unmounting, touch [NO].

4. Remove the card from the controller.
 - Push in the card until a 'click' sounds to unlock the card, and then pull it out.

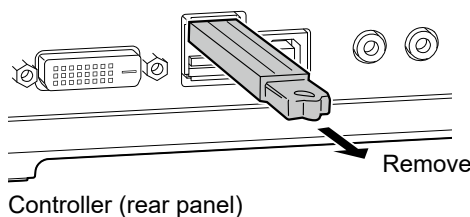
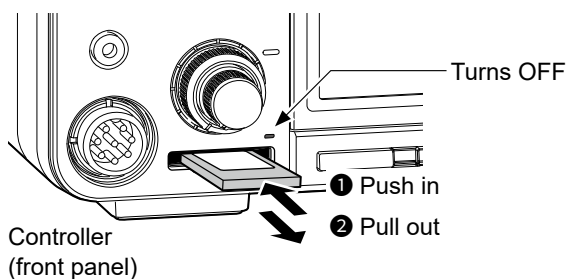

5. To close the SD CARD or USB FLASH DRIVE screen, push **EXIT** several times.

When the transceiver is OFF

You can remove the card starting from step 4 of the steps described above.

About the Antenna memory settings

This function saves antenna connector settings for each frequency band. You can set antenna connectors ANT1 ~ ANT4, ANT1/R ~ ANT4/R, or ANT1 ~ ANT4 to selected bands.
 ① ANT1 is set to all frequency bands as the default.

◆ The Antenna memory screen

The Antenna memories are set on the ANTENNA screen.

MENU » **ANTENNA**

Settings on the TYPE SET screen
Antenna selection mode

The Temporary function memory ON or OFF.

Displayed while a different antenna from the original is temporarily selected. (Example: ANT 2)

An example of antenna connector settings for each frequency band.

Key	Action
ANT	Selects [ANT1] ~ [ANT4]. • “★” is displayed if you temporarily select an antenna that is different from the one that is saved in the memory.
RX-ANT	Selects [ANT1/R] ~ [ANT4/R]. ① This key is displayed when “RX-ANT Connectors” is set to “Connect Receive Antenna” on the TYPE SET screen.
RX-I/O	Selects [ANT1] ~ [ANT4]. ① This key is displayed when “RX-ANT Connectors” is set to “Connect External RX Device” on the TYPE SET screen.
ANT MR	Recalls the originally saved antenna setting in the memory. ① This key can be used when [[ANT] SW] is set to “Auto.”
ANT MW	Touch for 1 second Saves the current antenna connector setting in the antenna memory.
TEMP-M	Turns the Temporary memory function ON or OFF. ① This function temporarily memorizes the antenna that is manually selected.
[ANT] SW	Sets the Antenna selection mode to “Auto,” “Manual,” or “OFF.” • Auto: Uses the Antenna memory. • Manual: Selects each antenna connector according to the saved settings.
TYPE	Displays the TYPE SET screen.

TIP:

- You cannot select an antenna connector that is turned OFF on the TYPE SET screen by touching [ANT].
- When in the Transverter operation, you cannot use the [ANT], [RX-ANT], and [RX-I/O] keys.

◆ Saving an antenna connector setting

Example: Assigning ANT2 to the 10 MHz band.

- Open the ANTENNA screen.

MENU » **ANTENNA**

- Select the 10 MHz band.

- Touch [ANT] and select “2 (ANT2).”

“2 ★” is displayed.

“2 ★” is displayed.

- You can recall the originally saved antenna setting (Example: ANT1), touch [ANT MR].

- Touch [ANT MW] for 1 second to save “2 (ANT2)” to the 10 MHz band.
• “★” disappears.

- To close the ANTENNA screen after saving, push **EXIT**.

NOTE: Before transmitting with a selected antenna, be sure that the selected antenna suits the operating frequency by using the antenna tuner (p. 7-3). Otherwise the transceiver may be damaged.

About the Antenna memory settings

◇ Setting the antenna type

On this screen, you can set the type of antenna to use.

1. Open the ANTENNA screen.
MENU » ANTENNA
2. Touch [TYPE].
 - The TYPE SET screen is displayed.
3. Touch “RX-ANT Connectors.”

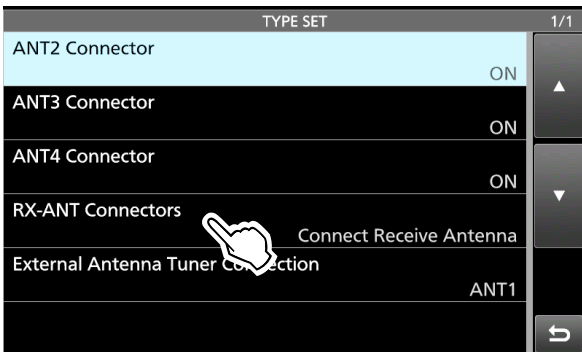

4. Select an option.
 (Example: Connect External RX Device)

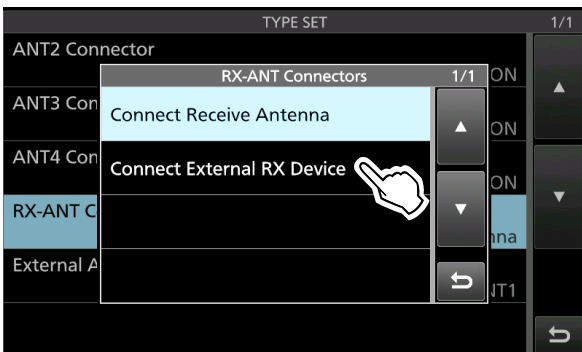

5. To close the TYPE SET screen, push EXIT several times.

ANT2 Connector (Default: ON)
ANT3 Connector (Default: ON)
ANT4 Connector (Default: ON)

Selects whether or not to enable use of the antenna connector.

- OFF: You cannot select the antenna connector.
 - ON: You can select the antenna connector.
- ① An external antenna tuner or antenna does not activate if you connect it to the antenna connector that is set to “OFF.”
- ① You cannot set the ANT1 connector to OFF.

RX-ANT Connectors
 (Default: Connect Receive Antenna)

Selects a device connected to [RX-ANT IN] and [RX-ANT OUT].

- Connect Receive Antenna:
 Select this option to connect a receive antenna to [RX-ANT IN].
 “R” is displayed next to the antenna number when [RX-ANT] is touched.
- Connect External RX Device:
 Select this option to connect an external receive device, such as a filter or preamplifier to [RX-ANT OUT] and [RX-ANT IN].
R is displayed next to the antenna number when [RX-I/O] is touched.

External Antenna Tuner Connection
 (Default: ANT1)

Selects an antenna connector to which the AH-730 optional antenna tuner is connected. The maximum output power from the selected connector is limited to 100 W.

- Set to ANT1, ANT2, ANT3, or ANT4.

NOTE: If you connect the AH-730 to another connector, the maximum 200 W power is input to the tuner, and could damage the tuner.

① Confirm the setting again after performing a Partial reset or an All reset.

About the internal antenna tuner

The internal automatic antenna tuner automatically matches the transceiver to the antenna within the range of 16.7 ~ 150 Ω (SWR of less than 1:3).

After the tuner matches an antenna, the latching relay combinations are memorized as a preset point for each frequency. Therefore, when you change the frequency, the latching relay combinations are automatically preset to the memorized point.

- ① When you install a new antenna, or you want to change the antenna settings, you can clear all of the internal antenna tuner preset points with the “<<Preset Memory Clear>>” item on the TUNER set screen. (p. 8-5)

MENU » SET > Function > Tuner >
 <<Preset Memory Clear>>

NOTE:

- If the SWR is higher than about 1.5:1, hold down **TUNER** for 1 second to start manual tuning.
- When the transceiver receives a strong physical shock, the internal latching relays may be returned to an unlatched condition. In that case, push **TUNER** to turn OFF the tuner, then turn it ON again to reset all latching relays.

◇ Using the Internal antenna tuner

1. Push **TUNER** to turn ON the internal antenna tuner.
 - The indicator on **TUNER** lights.
2. Match the antenna.
 - ① To match the antenna, see “Manual tuning” or “PTT Tuner start” below.

◇ Manual tuning

You can manually match the antenna before transmitting for the first time.

1. Hold down **TUNER** for 1 second to start manual tuning.
 - The indicator on **TUNER** blinks red.
 - ① The tuning normally takes 2~3 seconds.
2. After matching, the indicator on **TUNER** lights white, and the internal antenna tuner stays ON.
 - ① If the tuner cannot tune, the indicator on **TUNER** goes out, and the tuning circuit is automatically bypassed.

◇ PTT Tuner start

The tuner is always activated when [PTT] is pushed after the frequency is changed (more than 1% from the last-tuned frequency). This function matches the antenna for the first transmission on a new frequency.

- ① You can turn OFF this function in the “PTT Start” item on the TUNER screen. (p. 8-5)

MENU » SET > Function > Tuner > PTT Start

TIP: If the tuner cannot match the antenna

Even if the tuner cannot match the antenna on the first attempt, it may succeed by repeating the tuning several times.

About the external antenna tuner

The optional AH-730 antenna tuner matches the IC-7760 to a long wire antenna more than 7 m/23 ft long (1.8 MHz to 54 MHz).

⚠ DANGER HIGH VOLTAGE! NEVER touch the antenna element while tuning or transmitting. Always install it in a secure place.

NEVER operate the AH-730 without an antenna connected. The tuner and transceiver will be damaged.

◇ Using the AH-730

1. Turn ON the transceiver.
2. Push **TUNER** to start tuning.
 - The tuner reduces the SWR to less than 2:1 after 2~3 seconds.
 - ① While tuning, a side tone is heard and the indicator on **TUNER** blinks red.
 - ① If the tuner cannot reduce the SWR to less than 2:1 after 15 seconds of tuning, the indicator goes out.
3. After matching, the indicator stops blinking and lights white.
 - ① When the long wire antenna cannot be matched, the indicator goes out. In that case, the AH-730 is bypassed and the wire is directly connected.
4. To start manual tuning while the indicator lights white, hold down **TUNER** for 1 second.
5. To turn OFF (bypassed) the AH-730, push **TUNER**.

NOTE: When the wire antenna cannot be matched, check the wire length and connection. Note that the AH-730 cannot match a wire that is a $\frac{1}{2}\lambda$ long or on a multiple of that frequency.

◇ Using the IC-PW2

When you use the internal antenna tuner of the IC-PW2, be sure to turn OFF the IC-7760's internal antenna tuner before connecting it.

To tune at the desired operating frequency, do manual tuning on the IC-PW2.

- With the linked manual tuning function, the IC-7760 automatically starts transmitting at the same time.
- ① While tuning, you can select the displayed meter.
- ① To cancel the tuning, push **TUNER** on the IC-7760.
- ① See the IC-PW2 instruction manual for details.

◇ Using an external antenna tuner

When you use a non-Icom external antenna tuner, be sure to turn OFF the internal antenna tuner before connecting it.

Otherwise, the tuning may fail because both antenna tuners (internal and external) will simultaneously start tuning.

See the antenna tuner's instruction manual for details.

NOTE: Be sure not to connect the antenna tuner without an antenna connected. This could damage the transceiver or external antenna tuner.

TIP: If the SWR is not reduced to 2:1 after retuning, see "If the tuner cannot match the antenna" for details. (p. 7-3)

Set mode description

You can use the Set mode to set infrequently changed values or function settings.

1. Push **MENU**.

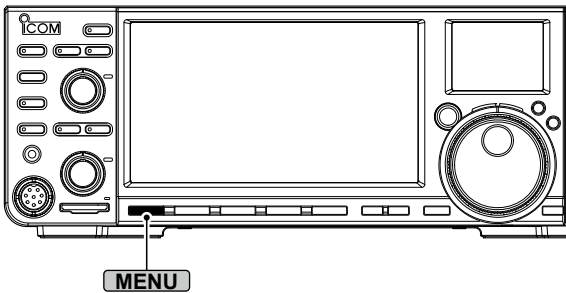

2. Touch [SET].

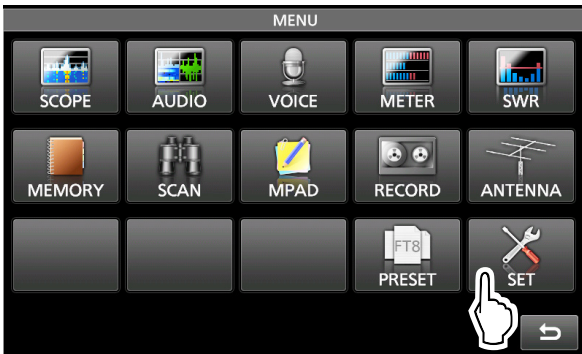

3. Touch the category that you want to select.

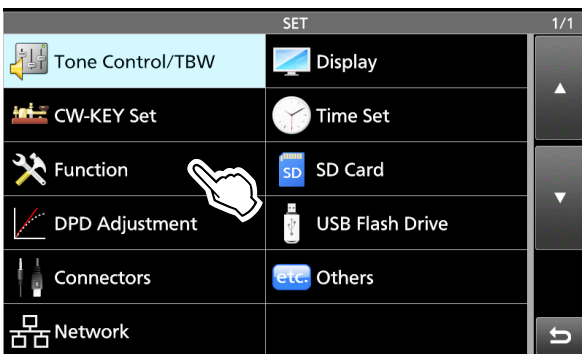

4. Touch [▲] or [▼] to scroll through the items.

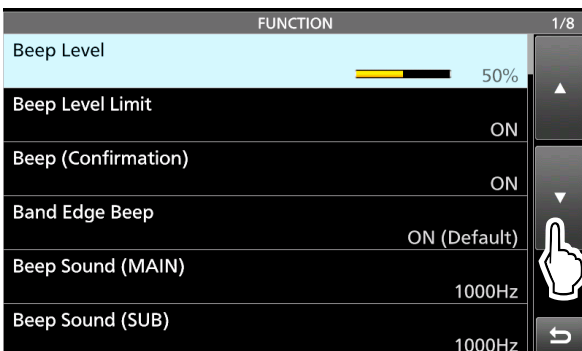

- ① You can also rotate **MULTI** to scroll through the items.

TIP: The Set mode is constructed in a tree structure. You can go to the next tree level, or go back a level, depending on the selected item.

5. Touch the item to open its setting screen, or to open its next tree level.

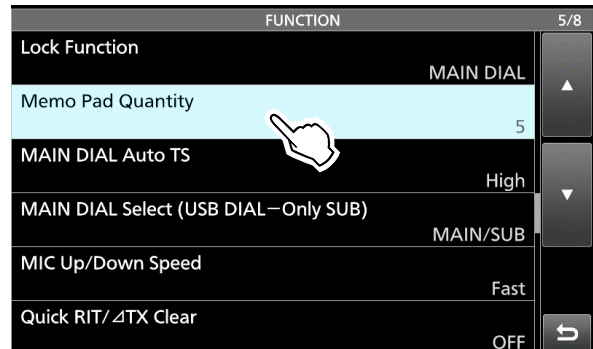

- ① Repeat steps 4 and 5 to open the desired item's setting screen.

- ① To go back a tree level, push **EXIT**.

6. Touch to select or to set the option.

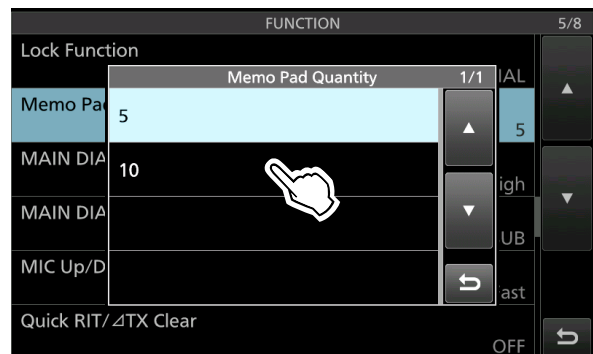

- The selected option is saved, and returns to the previous screen.

7. To close the SET screen, push **EXIT** several times.

TIP: Resetting to the default setting

1. Push **QUICK** to display the QUICK MENU screen.
2. Touch "Default" to reset to the default setting.

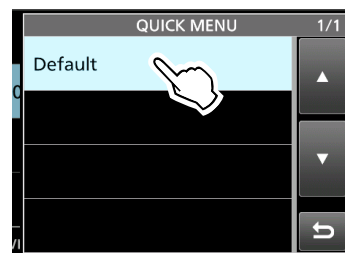

- ① To close the QUICK MENU screen, push **EXIT**.

NOTE: The default settings shown below are for the USA transceiver version. The default settings may differ, depending on your transceiver version.

Tone Control/TBW

MENU » SET > Tone Control/TBW > **RX**

SSB, AM, FM, CW, RTTY, PSK

RX HPF/LPF (Default: - - - - -)

Sets the cut-off frequencies for the receive audio high-pass filter and low-pass filter, in 100 Hz steps.

① If this item is set, the “RX Bass” and “RX Treble” items are automatically set to “0.”

① In the Data mode, the Tone Control settings are automatically disabled.

SSB, AM, FM

RX Bass (Default: 0)

RX Treble (Default: 0)

Sets the bass or treble level of the receive audio.

① In the Data mode, the Tone Control settings are automatically disabled.

MENU » SET > Tone Control/TBW > **TX**

SSB, AM, FM

TX Bass (Default: 0)

TX Treble (Default: 0)

Sets the bass or treble level of the transmit audio.

SSB

TBW (WIDE) (Default: 100 – 2900)

TBW (MID) (Default: 300 – 2700)

TBW (NAR) (Default: 500 – 2500)

Sets the transmission passband width to wide, mid, or narrow, by changing the lower and upper cut-off frequencies.

SSB-D

TBW (Default: 300 – 2700)

Sets the transmission passband width by changing the lower and upper cut-off frequencies.

CW-KEY Set

① You can also set the same items in the CW-KEY SET menu on the KEYER screen. (p. 4-13)

MENU » SET > **CW-KEY Set**

Side Tone Level (Default: 50%)

Adjusts the CW side tone output level.

- Adjust to between 0 ~ 100%.

Side Tone Level Limit (Default: ON)

Turns the CW side tone level limit ON or OFF. This function disables the CW side tone when you increase AF GAIN above the side tone level.

Keyer Repeat Time (Default: 2sec)

Sets the time between Memory keyer transmissions.

- Set to between 1 ~ 60 seconds.

① After transmitting a Memory keyer contents, the transmission is repeated after the set time period.

①  is displayed, even between transmissions.

Dot/Dash Ratio (Default: 1:1:3.0)

Sets the dot/dash ratio.

- Set to between 1:1:2.8 ~ 1:1:4.5 in 0.1 steps.

Keying weight example: Morse code “K”

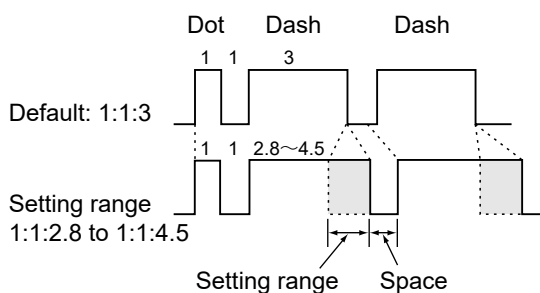

Rise Time (Default: 4ms)

Sets the rise time of the transmitted CW envelope.

- Set to 2, 4, 6, or 8 milliseconds.

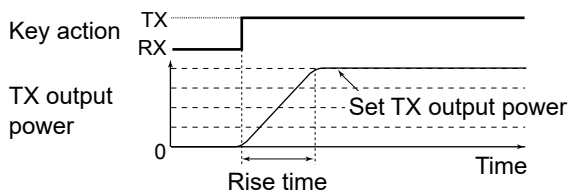

CW-KEY Set

Paddle Polarity (Default: Normal)

Sets the paddle dot-dash polarity to Normal or Reverse.

- Normal: Right = dash, Left = dot
- Reverse: Right = dot, Left = dash

Key Type (Default: Paddle)

Sets the key type for the [ELEC-KEY] jack on the controller's rear panel.

- Set to Straight, Bug, or Paddle.

① When using an external Elec-keyer, select "Straight."

MIC Up/Down Keyer (Default: OFF)

Selects whether or not to use the keys on the microphone as a CW key.

- OFF: Do not use the microphone keys as a CW key.
- ON: Use the [UP]/[DN] keys as a CW key.

① The microphone keys do not work as a "squeeze key."

① When "ON" is selected, you cannot use the function that is assigned to each key.

Function

MENU » **SET > Function**

Beep Level (Default: 50%)

Sets the beep output level.

① If "Beep (Confirmation)" is set to "OFF," no beeps sound.

Beep Level Limit (Default: ON)

Selects whether or not to limit the volume up to a specified level.

- OFF: Does not limit the volume level.
- ON: Limits the volume level.

Beep (Confirmation) (Default: ON)

Turns the Confirmation beep ON or OFF.

- OFF: Turns OFF the function for silent operation.
- ON: A beep sounds when a switch is pushed or the touch panel is touched.

① If "Beep Level" is set to "0%," no beep sounds.

Band Edge Beep (Default: ON (Default))

Selects an option for the Band Edge Beep function.

- OFF: Turns OFF the function.
- ON (Default): A beep sounds when you tune out of, or back into the default amateur band's frequency range.
- ON (User): A beep sounds when you tune out of, or back into a user programmed amateur band's frequency range.
- ON (User) & TX Limit: A beep sounds when you tune out of, or back into a user programmed amateur band's frequency range. Transmitting is inhibited outside of the range.

① If "Beep Level" is set to "0%," no beep sounds.

Beep Sound (MAIN) (Default: 1000Hz)**Beep Sound (SUB)** (Default: 1000Hz)

Sets the audio frequency for beeps to between 500 and 2000 Hz.

Speaker MAIN/SUB Mix (Default: OFF)

Sets the audio output from the internal and external speaker.

- OFF: Outputs the Main band's audio from the left side, and the Sub band's audio from the right side.
- ON: Outputs the mixed audio.

① See page 13-7 for details.

RF/SQL Control (Default: RF+SQL)

Set the AF RF/SQL (outer) control operation.

① See the Advanced manual for details.

Cancel CI-V Remote Set Levels (Default: All Volume Levels)

While remotely controlling the transceiver, sent CI-V commands override some of the control dials' setting values.

Select whether or not to overwrite all control dial's setting values (such as the AF Volume dial with a mark on it) by their position if one of them on the transceiver is rotated.

- All Volume Levels:
All dials' setting values are overwritten by their position, even if one of them is rotated.
- Operated Volume Level:
Only the rotated dial's setting value is overwritten by its position.

MENU » **SET > Function > TX Power Limit**

1.8M	(Default: 200W (AM: 50W))
1.8M (DATA)	(Default: 200W (AM: 50W))
3.5M	(Default: 200W (AM: 50W))
3.5M (DATA)	(Default: 200W (AM: 50W))
5M	(Default: 200W (AM: 50W))
5M (DATA)	(Default: 200W (AM: 50W))
7M	(Default: 200W (AM: 50W))
7M (DATA)	(Default: 200W (AM: 50W))
10M	(Default: 200W (AM: 50W))
10M (DATA)	(Default: 200W (AM: 50W))
14M	(Default: 200W (AM: 50W))
14M (DATA)	(Default: 200W (AM: 50W))
18M	(Default: 200W (AM: 50W))
18M (DATA)	(Default: 200W (AM: 50W))
21M	(Default: 200W (AM: 50W))
21M (DATA)	(Default: 200W (AM: 50W))
24M	(Default: 200W (AM: 50W))
24M (DATA)	(Default: 200W (AM: 50W))
28M	(Default: 200W (AM: 50W))
28M (DATA)	(Default: 200W (AM: 50W))
50M	(Default: 200W (AM: 50W))
50M (DATA)	(Default: 200W (AM: 50W))

Sets the power limit to between 2 W and 200 W for each selected band.

① The maximum output power from an antenna connector to which the AH-730 optional antenna tuner is connected is limited to 100 W.

MENU » **SET > Function > TX Delay**

HF (Default: OFF)
50M (Default: OFF)

Sets the TX delay time on each band.

① If an external equipment's rise time is slower than that of the IC-7760, a reflected wave is produced, and it may damage the IC-7760 or the external device. To prevent this, set the appropriate delay time so that no reflected wave or timing damage occurs.

① Select "OFF" for no delay.

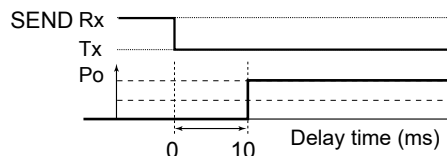

MENU » **SET > Function**

Time-Out Timer (CI-V) (Default: OFF)

Sets the Time-out Timer for CI-V operation to OFF, 3, 5, 10, 20, or 30 minutes to prevent an accidental prolonged transmission.

This setting is valid only for transmitting initiated by a CI-V command or pushing **TRANSMIT**.

① Select "OFF" for no time limit.

Quick Dualwatch (Default: ON)

Turns the Quick Dualwatch function ON or OFF by holding down **DUAL-W** for 1 second.

MENU » **SET > Function > SPLIT**

Quick SPLIT (Default: ON)

Turns the Quick SPLIT function ON or OFF. This function automatically turns ON the SPLIT function, and sets the frequency and mode according to the SPLIT Offset setting.

- OFF: Turns OFF the function.
- ON: Turns ON the function.

Display Keypad on Quick SPLIT (Default: OFF)

In the SSB, CW, RTTY, PSK, or AM mode, selects whether or not to display the F-INP screen by holding down **SPLIT** for 1 second.

FM SPLIT Offset (HF) (Default: -0.100 MHz)
FM SPLIT Offset (50M) (Default: -0.500 MHz)

In the FM mode, sets the SPLIT offset between -9.999 and +9.999 MHz.

The SPLIT offset is the difference between the receive and transmit frequencies for the Quick SPLIT function.

Function

MENU » **SET > Function > SPLIT**

SPLIT LOCK (Default: OFF)

Turns the Split Lock function ON or OFF. The SPLIT LOCK function enables you to adjust the transmit frequency while holding down **XFC**, even while the Dial Lock function is activated. To prevent accidentally changing the receive frequency by rotating **MAIN DIAL**, use both the SPLIT LOCK and Dial Lock functions (p. 3-9).

- OFF: Turns OFF the function.
- ON: Turns ON the function.

MENU » **SET > Function > Tuner**

PTT Start (Default: OFF)

Turns the PTT Start Tuning function ON or OFF. This function starts tuning when [PTT] is pushed, if the operating frequency is shifted 1% or more while the antenna tuner is ON.

<<Preset Memory Clear>>

Clears all of the internal antenna tuner's entered memory frequencies.

Select the antenna to clear the memory between "ANT 1," "ANT 2," "ANT 3," "ANT 4," and "All."

① To clear all antenna memories, select "All."

MENU » **SET > Function**

Transverter Function (Default: Auto)

Selects whether to turn ON the transverter function or to automatically turn it ON when 2 to 15 V DC is applied to pin 6 of [ACC 2].

Transverter Offset (Default: 16.000 MHz)

Sets the offset frequency for transverter operation.

IC-PW2 Dual Connection Mode (Default: OFF)

Synchronizes the operating frequency and band when the transceiver is connected to the IC-PW2's RF input connectors ([INPUT 1] and [INPUT 2]).

- OFF: Not synchronized with the IC-PW2.
- ON: Synchronized with the IC-PW2.

① When the IC-PW2 is not connected to the transceiver, BE SURE to select "OFF." Otherwise, you cannot use some functions, such as antenna switching.

RTTY Mark Frequency (Default: 2125)

Selects the RTTY mark frequency.

① When the internal RTTY decoder is used, 2125 Hz is automatically selected.

RTTY Shift Width (Default: 170)

Selects the RTTY shift width.

① When the internal RTTY decoder is used, 170 Hz is automatically selected.

RTTY Keying Polarity (Default: Normal)

Selects the RTTY keying polarity.

- Normal: Key open/close = Mark/Space
- Reverse: Key open/close = Space/Mark

PSK Tone Frequency (Default: 1500)

Selects the PSK tone frequency for PSK reception.

MENU » **SET > Function > SPEECH**

SPEECH Language (Default: English)

Sets the speech language to English or Japanese.

SPEECH Speed (Default: Fast)

Sets the speech speed to Fast or Slow.

S-Level SPEECH (Default: ON)

Turns the S-meter level announcement ON or OFF.

- OFF: The operating mode and the operating frequency are announced when you push **SPEECH**.
- ON: The signal strength level, the operating mode, and the operating frequency are announced when you push **SPEECH**.

MODE SPEECH (Default: OFF)

Turns the operating mode announcement ON or OFF.

- OFF: The selected operating mode is not announced.
- ON: The selected operating mode is announced.

SPEECH Level (Default: 50%)

Sets the Voice Synthesizer audio output level.

MENU » **SET > Function**

[SPEECH/LOCK] Switch (Default: SPEECH/LOCK)

Selects **[SPEECH]** action.

- **SPEECH/LOCK:** Pushing **[SPEECH]** turns ON the Voice Synthesizer function. Holding down **[SPEECH]** turns the Lock function ON or OFF.
- **LOCK/SPEECH:** Pushing **[SPEECH]** turns the Lock function ON or OFF. Holding down **[SPEECH]** turns ON the Voice Synthesizer function.

Lock Function (Default: MAIN DIAL)

This function electronically locks **[MAIN DIAL]** or the panel display* to prevent accidental changes.

* Keys and dials are also locked except for **[AF-RF/SQL]**, **[POWER]**, and **[SPEECH]**.

Memo Pad Quantity (Default: 5)

Sets the number of memo pad channels to 5 or 10.

MAIN DIAL Auto TS (Default: High)

Sets the Auto Tuning Step function for **[MAIN DIAL]**.

When rapidly rotating **[MAIN DIAL]**, the tuning step automatically changes according to the rotation speed.

- **OFF:** Auto tuning step is turned OFF.
- **Low:** Approximately two times faster.
- **High:** Approximately five times faster when the tuning step is set to 1 kHz or smaller. Approximately two times faster when the tuning step is set to 5 kHz or larger.

MAIN DIAL Select (USB DIAL - SUB Only) (Default: MAIN/SUB)

Selects whether **[MAIN DIAL]** changes only the Main band frequency, or changes both the Main and Sub band frequencies, depending on which band is selected.

① This is convenient when using the optional RC-28 REMOTE ENCODER to change the Sub band frequency.

MIC Up/Down Speed (Default: Fast)

Selects the steps per second when changing an operating frequency by holding down the microphone's **[UP]/[DN]** key.

- **Slow:** Low speed (25 tuning steps/second)
- **Fast:** High speed (50 tuning steps/second)

Quick RIT/ Δ TX Clear (Default: OFF)

Selects the **[CLEAR]** operation for the RIT and Δ TX functions.

- **OFF:** Holding down **[CLEAR]** for 1 second resets the RIT or Δ TX shift frequency.
- **ON:** Pushing **[CLEAR]** resets the RIT or Δ TX shift frequency.

[NOTCH] Switch (SSB) (Default: Auto/Manual)

[NOTCH] Switch (AM) (Default: Auto/Manual)

Selects the Notch function used in the SSB or AM mode.

- **Auto:** Only the Auto Notch function can be used.
- **Manual:** Only the Manual Notch function can be used.
- **Auto/Manual:** Both the Auto and Manual Notch functions can be used.

FILTER Screen MAIN/SUB Select (Default: Auto (by FILTER, PBT Operation))

Selects whether or not to automatically switch the IF filter or Twin PBT settings when Main and Sub bands are switched between each other, while displaying the FILTER screen.

SSB/CW Synchronous Tuning (Default: OFF)

Turns the Displayed Frequency Shift function ON or OFF. This function automatically shifts the frequency to match the CW pitch when the operating mode is toggled between SSB and CW.

- **OFF:** Turns OFF the function.
- **ON:** When the operating mode is changed between SSB and CW, the operating frequency shifts by the offset amount.

CW Normal Side (Default: LSB)

Selects the carrier point in the CW normal mode.

- **LSB:** Sets the carrier point to the LSB side.
- **USB:** Sets the carrier point to the USB side.

MENU » **SET > Function > Front Key Customize**

[VOX/BK-IN] (Default: VOX/BK-IN)

[AUTOTUNE] (Default: AUTOTUNE)

The function assignments for the **[VOX/BK-IN]** and **[AUTO TUNE]** keys on the front panel can be changed.

① See page 8-7 about the functions.

Function

MENU » **SET > Function > MIC Key Customize**

[UP] (Default: UP (VFO: kHz))
[DN] (Default: DOWN (VFO: kHz))

The function assignments for the [UP] and [DN] keys on the SM-50 or HM-219 optional microphone can be changed.

① See page 8-8 about the functions.

MENU » **SET > Function**

Screen Keyboard Type (Default: Full Keyboard)

Sets the keyboard entry type to Ten-Key or Full Keyboard.

Screen Full Keyboard Layout (Default: English)

Sets the on-screen keyboard layout to English, German, or French.

Screen Capture [POWER] Switch (Default: OFF)

Assigns the Screen Capture function to **POWER**.

- OFF: **POWER** does not act as the Screen Capture key.
- ON: **POWER** acts as the Screen Capture key.

Screen Capture Keyboard [Print Screen] (Default: OFF)

Assigns the Screen Capture function to the [Print Screen] key on the USB keyboard.

Screen Capture Storage Media (Default: SD Card)

Selects the SD card or USB flash drive to save screen capture data.

Screen Capture File Type (Default: PNG)

Sets the file format for the Screen Capture function to PNG or BMP.

Calibration Marker (Default: OFF)

Turns the reference frequency calibration marker ON or OFF.

REF Adjust

Adjusts the internal reference frequency.

NOTE: The default setting of "REF Adjust" may differ slightly, depending on each transceiver.

The assignable key functions for Front Key:

Function	Description
VOX/BK-IN*	Push to turn the VOX function in the Voice operation modes and the Break-in function in the CW mode ON or OFF. ① This function can be assigned for only VOX/BK-IN .
AUTOTUNE	In the AM or CW mode Push to automatically tune the operating frequency to a close-by signal. ① This function can be assigned for only AUTO TUNE .
PRESET	Push to open the PRESET screen.
Voice/Keyer/RTTY/PSK Memory 1	In the SSB, AM, or FM mode <ul style="list-style-type: none"> • Push to transmit the voice audio recorded on the SD card once. • Hold down for 1 second to repeatedly transmit the voice audio. ① If the voice audio is not saved in the Voice TX memory (T1 ~ T4), this function is disabled.
Voice/Keyer/RTTY/PSK Memory 2	In the CW mode <ul style="list-style-type: none"> • Push to transmit the Keyer memory content once. • Hold down for 1 second to repeatedly transmit the memory content. ① If the Keyer memory content (M1 ~ M4) is not entered, this function is disabled.
Voice/Keyer/RTTY/PSK Memory 3	In the RTTY mode Push to transmit the RTTY memory content once. ① If the RTTY memory content (RT1 ~ RT4) is not entered, this function is disabled.
Voice/Keyer/RTTY/PSK Memory 4	In the PSK mode Push to transmit the PSK memory content once. ① If the PSK memory content (PT1 ~ PT4) is not entered, this function is disabled.

* Hold down for 1 second to open its function menu.

NOTE: When you assign other than "VOX/BK-IN" (default) to **VOX/BK-IN**, the indicator on **VOX/BK-IN** does not light even if you turn ON the VOX or Break-in function.

The assignable key functions for MIC Key:

Function	Description
---	No function
UP	Push to increase the frequency (in 50 Hz steps*) or Memory channel. * When the Tuning Step function is ON, increases the frequency in the selected Tuning Step.
DOWN	Push to decrease the frequency (in 50 Hz steps*) or Memory channel * When the Tuning Step function is ON, increases the frequency in the selected Tuning Step.
UP (VFO: kHz)	Push to increase the frequency (in the selected Tuning Step) or Memory channel.
DOWN (VFO: kHz)	Push to decrease the frequency (in the selected Tuning Step) or Memory channel.
XFC	Hold down for 1 second to monitor signals.
VFO/MEMO	<ul style="list-style-type: none"> Push to select the VFO mode and the Memory mode. Hold down for 1 second to copy the Memory channel contents to the VFO.
BAND UP	<ul style="list-style-type: none"> Push to increase an operating band. Hold down for 1 second to recall the Band Stacking Register contents.
BAND DOWN	<ul style="list-style-type: none"> Push to decrease an operating band. Hold down for 1 second to recall the Band Stacking Register contents.
SPEECH	Push to announce the S-meter level, frequency, and operating mode. ① The announced information depends on the settings.
MODE	<ul style="list-style-type: none"> Push to select the operating mode. Hold down to toggle USB and LSB, CW and CW-R, RTTY and RTTY-R, or PSK and PSK-R.

Function	Description
Voice/Keyer/RTTY/PSK Memory 1	<p>In the SSB, AM, or FM mode</p> <ul style="list-style-type: none"> Push to transmit the voice audio recorded on the SD card once. Hold down for 1 second to repeatedly transmit the voice audio. <p>① If the voice audio is not saved in the Voice TX memory (T1 ~ T4), this function is disabled.</p>
Voice/Keyer/RTTY/PSK Memory 2	<p>In the CW mode</p> <ul style="list-style-type: none"> Push to transmit the Keyer memory content once. Hold down for 1 second to repeatedly transmit the memory content. <p>① If the Keyer memory content (M1 ~ M4) is not entered, this function is disabled.</p>
Voice/Keyer/RTTY/PSK Memory 3	<p>In the RTTY mode</p> <p>Push to transmit the RTTY memory content once.</p> <p>① If the RTTY memory content (RT1 ~ RT4) is not entered, this function is disabled.</p>
Voice/Keyer/RTTY/PSK Memory 4	<p>In the PSK mode</p> <p>Push to transmit the PSK memory content once.</p> <p>① If the PSK memory content (PT1 ~ PT4) is not entered, this function is disabled.</p>
TS	<ul style="list-style-type: none"> Push to turn the Tuning Step function ON or OFF. Hold down for 1 second to open the TS screen.
MPAD	<ul style="list-style-type: none"> Push to sequentially call up the contents in the Memo Pads. Hold down for 1 second to save the displayed contents into the Memo Pad.
SPLIT	<ul style="list-style-type: none"> Push to turn the Split function ON or OFF. Hold down for 1 second to turn ON the Quick Split function.
CHANGE	<ul style="list-style-type: none"> Push to toggle the frequency, mode, and selected memory channel between the Main and Sub band. Hold down for 1 second to copy the Main band settings to the Sub band.
TUNER	<ul style="list-style-type: none"> Push to turn the antenna tuner ON or OFF. While the indicator on TUNER blinks red, hold down for 1 second to start manual tuning.

DPD Adjustment

MENU » **SET > DPD Adjustment**

IC-7760 Single Adjustment

Displays the screen for selecting the band for the DPD single adjustment and checking the adjustment status of each band is displayed.

IC-PW2 Linked Adjustment (200V)

Displays the screen for selecting the band for the DPD linked adjustment with the IC-PW2 at 180 ~ 264 V AC and checking the adjustment status of each band at 1 kW or 500 W output is displayed.

- ① The adjustment starts at the maximum output power selected on the IC-PW2.
- ① If the IC-PW2 is not connected, the previous DPD linked adjustment status will be displayed.
- ① Before performing the DPD linked adjustment, the DPD single adjustment must be completed.

IC-PW2 Linked Adjustment (100V)

Displays the screen for selecting the band for the DPD linked adjustment with the IC-PW2 at 90 ~ 132 V AC and checking the adjustment status of each band at 500 W output is displayed.

- ① If the IC-PW2 is not connected, the previous DPD linked adjustment status will be displayed.
- ① Before performing the DPD linked adjustment, the DPD single adjustment must be completed.

Connectors

MENU » **SET > Connectors > Phones**

Level (Default: 0)

Sets the audio output level ratio of the headphones and internal speaker between -15 and +15.

L/R Mix (Default: ON)

Selects to output the mixed audio from the headphones or to output the Main band's audio from the left side and the Sub band's audio from the right side.

L/R Mix Level (Default: 70%)

When "L/R Mix" is set to "ON," sets the mixed level of the Main and Sub band's audio.

MENU » **SET > Connectors > USB AF/IF Output**

Output Select (Default: AF)

Selects the signal output from the [USB B] port on the controller's rear panel.

- AF: An AF signal is output.
- IF: A 12 kHz IF signal is output.

AF/IF XFC Output (SPLIT ON) (Default: SUB)

Selects the signal output from the [USB B] port on the controller's rear panel while holding down **XFC** in split operation.

AF Output Level (Default: 50%)

Sets the AF output level of the [USB B] port on the controller's rear panel, when "Output Select" of USB is set to "AF."

AF SQL (Default: OFF (Open))

Selects whether or not to output the audio from the [USB B] port on the controller's rear panel, depending on the squelch state, when "Output Select" of USB is set to "AF."

- OFF (Open): The squelch is always open, regardless of the transceiver's squelch level.
- ON: The squelch opens and closes, according to the transceiver's squelch level.

AF Beep/Speech... Output (Default: OFF)

Sets the Beep and Speech audio output setting of the [USB B] port on the controller's rear panel, when "Output Select" of USB is set to "AF."

- OFF: The beep and speech audio are not output.
- ON: The beep and speech audio are output.

IF Output Level (Default: 50%)

Sets the IF output level of the [USB B] port on the controller's rear panel, when "Output Select" of USB is set to "IF."

MENU » SET > Connectors > **LINE-OUT AF/IF Output****AF Output Select** (Default: MAIN)

Selects the audio signals to output from the [LINE OUT] jack on the controller's rear panel in the Main and Sub bands.

Output Select (Default: AF)

Selects the signal output from the [LINE OUT] jack on the controller's rear panel.

- AF: An AF signal is output.
- IF: A 12 kHz IF signal is output.

AF/IF XFC Output (SPLIT ON) (Default: MAIN)

Selects the signal output from the [LINE OUT] jack on the controller's rear panel while holding down **XFC** in split operation.

AF Output Level (Default: 50%)

Sets the AF output level of the [LINE OUT] jack on the controller's rear panel, when "Output Select" of LINE-OUT is set to "AF."

AF SQL (Default: OFF (Open))

Selects whether or not to output the audio from the [LINE OUT] jack on the controller's rear panel, depending on the squelch state, when "Output Select" of LINE-OUT is set to "AF."

- OFF (Open): The squelch is always open, regardless of the transceiver's squelch level.
- ON: The squelch opens and closes, according to the transceiver's squelch level.

AF Beep/Speech... Output (Default: OFF)

Sets the Beep and Speech audio output setting of the [LINE OUT] jack on the controller's rear panel, when "Output Select" of LINE-OUT is set to "AF."

- OFF: The beep and speech audio are not output.
- ON: The beep and speech audio are output.

IF Output Level (Default: 50%)

Sets the IF output level of the [LINE OUT] jack on the controller's rear panel, when "Output Select" of LINE-OUT is set to "IF."

MENU » SET > Connectors > **ACC AF/IF Output****AF/SQL Output Select** (Default: MAIN)

Selects the audio and squelch signals to output from the [ACC 1] socket (Audio: pin 5, Squelch: pin 6) on the RF deck's rear panel in the Main and Sub bands.

Output Select (Default: AF)

Selects the signal output from the [ACC 1] socket on the RF deck's rear panel.

- AF: An AF signal is output.
- IF: A 12 kHz IF signal is output.

AF/IF XFC Output (SPLIT ON) (Default: MAIN)

Selects the signal output from the [ACC 1] socket on the RF deck's rear panel while holding down **XFC** in split operation.

AF Output Level (Default: 50%)

Sets the AF output level of the [ACC 1] socket on the RF deck's rear panel, when "Output Select" of ACC is set to "AF."

AF SQL (Default: OFF (Open))

Selects whether or not to output the audio from the [ACC 1] socket on the RF deck's rear panel, depending on the squelch state, when "Output Select" of ACC is set to "AF."

- OFF (Open): The squelch is always open, regardless of the transceiver's squelch level.
- ON: The squelch opens and closes, according to the transceiver's squelch level.

AF Beep/Speech... Output (Default: OFF)

Sets the Beep and Speech audio output setting of the [ACC 1] socket on the RF deck's rear panel, when "Output Select" of ACC is set to "AF."

- OFF: The beep and speech audio are not output.
- ON: The beep and speech audio are output.

IF Output Level (Default: 50%)

Sets the IF output level of the [ACC 1] socket on the RF deck's rear panel, when "Output Select" of ACC is set to "IF."

Connectors

MENU » SET > Connectors > LAN AF/IF Output

Output Select (Default: AF)

Selects the signal output from the [LAN] connector.

- AF: An AF signal is output.
- IF: A 12 kHz IF signal is output.

AF SQL (Default: ON)

Selects whether or not to output the audio from the [LAN] connector, depending on the squelch state, when "Output Select" of LAN is set to "AF."

- OFF (Open): The squelch is always open, regardless of the transceiver's squelch level.
- ON: The squelch opens and closes, depending on the transceiver's squelch level.

MENU » SET > Connectors > MOD Input

- USB MOD Level** (Default: 50%)
- LINE-IN MOD Level** (Default: 50%)
- ACC MOD Level** (Default: 50%)
- LAN MOD Level** (Default: 50%)

Sets the modulation input level of each interface.

DATA OFF MOD (Default: MIC,USB,ACC)

In the SSB, AM, or FM mode, selects the connector(s) to input the modulation signal when the Data mode is OFF.

- DATA1 MOD** (Default: USB)
- DATA2 MOD** (Default: LINE-IN)
- DATA3 MOD** (Default: ACC)

In the SSB, AM, or FM mode, selects the connector(s) to input the modulation signal when the Data mode is ON.

① Touching the [DATA] key in the MODE screen activates the Data mode, and automatically sets the modulation input to the "MIC," "USB," "LINE-IN," "ACC," "MIC, USB," "MIC, LINE-IN," "MIC, ACC," "MIC, USB, ACC," "MIC, LINE-IN, ACC," or "LAN" connector(s) selected in these items, for all three Data modes.

MENU » SET > Connectors > USB SEND/Keying

TIP: This is the setting for the terminal used for data communication when you operate the transceiver using software on a PC.

The transceiver has 2 virtual COM ports, A and B. When connecting the [USB B] port on the controller's rear panel to your PC, the ports are virtually named "IC-7760 Serial Port A (CI-V)" and "IC-7760 Serial Port B."

USB SEND (Default: OFF)

Sets the USB terminal of the transceiver to receive the SEND signal from the software on the PC. Select the same terminal as the terminal set by the software.

① You cannot select the terminal which is already selected in the "USB Keying (CW)" or "USB Keying (RTTY)" item.

USB Keying (CW) (Default: OFF)

Sets the USB terminal of the transceiver to receive the CW Keying signal from the software on the PC. Select the same terminal as the terminal set by the software.

① You cannot select the terminal which is already selected in the "USB SEND" or "USB Keying (RTTY)" item.

USB Keying (RTTY) (Default: OFF)

Sets the USB terminal of the transceiver to receive the RTTY Keying signal from the software on the PC. Select the same terminal as the terminal set by the software.

① You cannot select the terminal which is already selected in the "USB SEND" or "USB Keying (CW)" item.

MENU » SET > Connectors > External Keypad

- VOICE** (Default: OFF)
- KEYER** (Default: OFF)
- RTTY** (Default: OFF)
- PSK** (Default: OFF)

Enables each memory (voice, keyer, RTTY, PSK) transmission using an external keypad.

MENU » SET > Connectors > **Keyboard/Mouse****Keyboard [F1]-[F8] (VOICE)** (Default: OFF)**Keyboard [F1]-[F8] (KEYER)** (Default: OFF)

Enables each memory (voice, keyer) transmission using a keyboard connected to the [USB A] port on the controller's rear panel.

Keyboard Type (Default: English)

Selects the keyboard language.

Keyboard Repeat Delay (Default: 250ms)

Sets the repeat delay time of the keyboard.

Keyboard Repeat Rate (Default: 10.9cps)

Sets the repeat rate of the keyboard.

Mouse Pointer Speed (Default: MID)

Selects the mouse pointer speed.

Mouse Pointer Acceleration (Default: ON)

Turns the mouse pointer acceleration ON or OFF.

MENU » SET > Connectors > **USB DIAL****USB DIAL Select** (Default: Only SUB)

Selects the Sub band or Main and Sub band to operate on the RC-28's main dial.

① When this item is set to "Only SUB," you can select whether **(MAIN DIAL)** changes only the Main band frequency, or changes both the Main and Sub band frequencies depending on which band is selected.

MENU » SET > Function >
MAIN DIAL Select (USB DIAL - SUB Only)

USB DIAL Auto TS (Default: High)

Selects the Automatic Tuning Step for the RC-28's main dial.

When rapidly rotating the RC-28's main dial, the tuning step is automatically changed according to the rotation speed.

USB DIAL [TRANSMIT] Switch

(Default: Push to toggle)

Selects whether to toggle between transmit and receive by pushing, or to transmit only while holding the [TRANSMIT] key on the RC-28.

MENU » SET > Connectors > **CI-V****CI-V Baud Rate** (Default: Auto)

Selects the CI-V data transfer rate.

① When "Auto" is selected, the baud rate is automatically set according to the data rate of the connected device.

CI-V Address (Default: B2h)

Sets the CI-V address in hexadecimal code.

① "B2" is the default address of the IC-7760.

CI-V Transceive (Default: ON)

Turns the Transceive function ON or OFF.

- OFF: The status is not output.
- ON: The status is output. When you change a setting on the transceiver, the same change is automatically set on other connected transceivers or receivers, and vice versa.

CI-V USB/LAN→REMOTE Transceive Address

(Default: 00h)

Sets the address used to remotely control the transceiver or receiver using the optional RS-BA1, through the [USB B] port on the controller's rear panel or the [LAN] port on the RF deck's rear panel.

The external equipment control signal is output from the [REMOTE] jack on the RF deck's rear panel.

CI-V Output (for ANT) (Default: OFF)

Enables outputting the antenna controller status (frequency and so on) from the [REMOTE] jack on the RF deck's rear panel.

① Address "01h" is reserved.

The usable addresses are limited to 02h ~ DFh.

CI-V USB (A) Echo Back (Default: OFF)**CI-V USB (B) Echo Back** (Default: OFF)

Turns the Data Echo Back function ON or OFF, when remotely controlling the IC-7760 through the [USB B] port on the controller's rear panel.

Connectors

MENU » SET > Connectors

USB (B) Function (Default: RTTY/PSK Decode)

The transceiver has 2 virtual COM ports, A and B. In this item, sets the function to be assigned to virtual COM port B.

- ① Virtual COM port A is used for CI-V operation.
- ① When connecting the [USB B] port on the controller's rear panel to your PC, the ports are virtually named "IC-7760 Serial Port A (CI-V)" and "IC-7760 Serial Port B."
- RTTY/PSK Decode:
 - Outputs the decoded data of the RTTY or PSK signal.
- CI-V: Inputs or outputs CI-V commands.

SEND Relay Type (Default: MOS-FET)

Selects the switching relay type to use the linear amplifier.

- ① Select the suitable relay type, especially when connecting a non-lcom linear amplifier.

ACC BAND Voltage Output (Default: TX)

Selects the operating band voltage output from the [ACC 2] socket (pin 4) on the RF deck's rear panel.

MIC Input DC Bias (Default: ON)

Outputs the 8 V bias voltage (approximate) from the [MIC] connector (pin 1) on the controller's front panel.

PTT Port Function (Default: PTT Input)

Set the behavior of the PTT pin on the [MIC] connector.

- PTT Input:
 - While transmitting, the transceiver does not output the SEND signal (TX status) from the PTT pin, but does detect the PTT input (PTT operation) on the microphone.
- PTT Input + SEND Output:
 - While transmitting using other than the operating microphone, the transceiver does not detect the PTT input (PTT operation) of the microphone, due to the output SEND signal from the PTT pin.

NOTE: If you want to cancel transmitting the recorded audio by pushing [PTT] on the microphone, set to "PTT Input."

REF IN (Default: OFF)

Selects the transceiver's reference frequency signal source.

- ① If the applied reference signal is off frequency, or not high enough, the IC-7760 will not work correctly. In that case, select "OFF."

Network

* This setting is valid after restarting the transceiver.

- ① See the Advanced manual for details about the IP addresses.

MENU » **SET > Network**

DHCP* (Default: ON)

Turns the DHCP function ON or OFF.

- OFF: Uses static IP addresses.
- ON: Uses the DHCP function. If a DHCP server is in your network environment, the IP addresses are automatically obtained.

- ① When this function is ON, you can check the settings assigned by the DHCP server by touching "IP Information" on the QUICK MENU screen.

- ① Confirm that a DHCP server is in a network to which the RF deck (and the controller) is connected.

IP Address (LAN)* (Default: 192.168.0.10)

Sets a static IP address.

- ① You cannot set the same address as "IP Address (Controller)," "IP Address (RF Deck)," and "Default Gateway."
- ① When the controller and RF deck are connected through a network, set all of "IP Address (LAN)," "IP Address (Controller)," and "IP Address (RF Deck)."
- ① When you are operating the IC-7760 using the optional RS-BA1, "IP Address (LAN)" is used to access.

IP Address (Controller)* (Default: 192.168.0.11)

Sets a static IP address.

- ① You cannot set the same address as "IP Address (LAN)," "IP Address (RF Deck)," and "Default Gateway."
- ① When the controller and RF deck are connected through a network, set all of "IP Address (LAN)," "IP Address (Controller)," and "IP Address (RF Deck)."

IP Address (RF Deck)* (Default: 192.168.0.12)

Sets a static IP address.

- ① You cannot set the same address as "IP Address (LAN)," "IP Address (Controller)," and "Default Gateway."
- ① When the controller and RF deck are connected through a network, set all of "IP Address (LAN)," "IP Address (Controller)," and "IP Address (RF Deck)."
- ① To connect the controller and RF deck between different segments, set "Connection from Different Segment" to ON, and then set the items in the "Different Segment Settings" menu.

Subnet Mask* (Default: 255.255.255.0(24 bit))

Sets the subnet mask to connect to your PC or Local Area Network (LAN), through your router.

Default Gateway* (Default:)

Sets the Default Gateway of the IC-7760.

- ① A Default Gateway setting is required when:
- Remotely controlling the IC-7760.
 - Using the NTP function.
 - Connecting the controller and RF deck between different segments.

Primary DNS Server* (Default:)

Sets the Primary DNS Server address.

Secondary DNS Server* (Default:)

If there are two DNS server addresses, sets the secondary DNS server address.

Audio Buffer Size (via LAN)* (Default: Mid)

When the controller and RF deck are connected through a network, selects the audio buffer size to reduce audio interruptions.

Connection from Different Segment* (Default: OFF)

Set to "ON" to connect the controller and RF deck between different segments.

MENU » **SET > Network > Different Segment Settings**

- ① Displayed only when "Connection from Different Segment" is set to "ON."

IP Address (RF Deck)* (Default: 192.168.100.10)

Sets a static IP address.

- ① You cannot set the same address as "Default Gateway."

Subnet Mask (RF Deck)* (Default: 255.255.255.0(24 bit))

Sets the subnet mask of the network that the RF deck is connected to.

Default Gateway (RF Deck)* (Default: 192.168.100.1)

Sets the Default Gateway of the RF deck.

Audio Buffer Size* (Default: Mid)

Selects the audio buffer size to reduce audio interruptions.

This setting is valid only when connecting the controller and RF deck between different segments.

Network

* This setting is valid after restarting the transceiver.

MENU » **SET > Network**

Network Name

If you are operating the IC-7760 using the optional RS-BA1, enter a network name of up to 15 characters.

MENU » **SET > Network > Remote Settings**

Network Control* (Default: OFF)

Selects whether or not to remotely control the IC-7760.

- OFF: Disables remote control of the IC-7760.
- ON: Enables remote control of the IC-7760.

Power OFF Setting (for Remote Control) (Default: Shutdown only)

Selects whether or not to display the Standby/Shutdown option dialog after holding down **POWER** for 1 second.

- Shutdown only: Shuts down the transceiver when you turn it OFF.
- Standby/Shutdown: Displays the Standby/Shutdown option dialog when you turn it OFF.

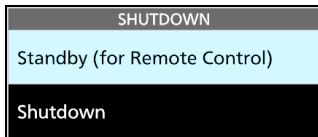

① When in the Standby mode, the indicator on **POWER** blinks orange.

Control Port (UDP)* (Default: 50001)

Sets a port number for the control signal transfers between the IC-7760 and the remote station, when you remotely control the IC-7760.

Serial Port (UDP)* (Default: 50002)

Sets a port number for the serial data transfers between the IC-7760 and the remote station, when you remotely control the IC-7760.

Audio Port (UDP)* (Default: 50003)

Sets a port number for the audio signal transfers between the IC-7760 and the remote station, when you remotely control the IC-7760.

Internet Access Line* (Default: FTTH)

Selects the Internet access line setting for the IP remote control.

MENU » **SET > Network > Remote Settings > Network User1**

MENU » **SET > Network > Remote Settings > Network User2**

Network User1 ID

Network User2 ID

Sets a user name of up to 16 characters to use when you remotely control the IC-7760.

Network User1 Password

Network User2 Password

Sets a user password.

- ① The password must include a minimum of 8 characters and a maximum of 16 characters.
- ① You cannot use a password that consists of only the same characters.

Network User1 Administrator (Default: NO)

Network User2 Administrator (Default: NO)

Selects whether or not to set the user as an administrator.

Only an authorized user can disconnect communication between the IC-7760 and the remote station.

MENU » **SET > Network > Remote Settings**

Network Radio Name (Default: IC-7760)

Sets the IC-7760's name of up to 16 characters that is displayed in the remote control software, when you remotely control the IC-7760.

Display

MENU » **SET > Display**

LCD Backlight (Default: 50%)

Sets the LCD backlight brightness.

LED Bright (Default: 80%)

Sets the LED brightness.

Display Font (Default: Round)

Selects the font for the frequency readout.

Meter Response (Standard, Edgewise) (Default: Mid)

Sets the meter needle response speed to Slow, Mid, or Fast.

Meter Type (Normal Screen) (Default: Standard)

Meter Type (Expand Screen) (Default: Bar)

Sets the S/Rf meter type for each display to Standard, Edgewise, or Bar.

Meter Peak Hold (Bar) (Default: ON)

Turns the Meter Peak Hold function ON or OFF.

Memory Name (Default: ON)

Turns the Memory name display in the Memory mode ON or OFF.

MENU » **SET > Display > Filter Effect Screen**

Waveform Type (Default: Fill)

Selects the outline waveform display for the FFT scope.

- Fill: Displays only the waveform, in color.
- Fill+Line: Displays both the waveform and the outline, in color.

Waveform Color (Default: (R) 51 (G) 153 (B) 255)

Sets the waveform color for the FFT scope.

① Touch and select the R (Red), G (Green), or B (Blue) scale, and then rotate **MULTI** to adjust the level from 0 to 255.

① The color is displayed in the box above the RGB scale.

MENU » **SET > Display**

Screen Saver (Default: 60min)

Sets the Screen Saver function.

This function activates and automatically turns OFF the screen when no operation is performed for the preset period of time.

① While this function is activating, the indicator on **NR** blinks white.

External Display (Default: OFF)

Select "ON" when using an external display.

External Display Resolution (Default: 800x480)

Select the screen resolution of the external display.

Opening Message (Default: ON)

Selects whether or not to display the opening message at power ON.

My Call

Sets a text displayed as the opening message, up to 10 characters. (Example: your call sign)

Display Language (Default: English)

Sets the screen display language to English or Japanese.

Time Set

MENU » SET > Time Set > **Date/Time**

Date

Sets the date (Year/Month/Day).

① The day of the week is automatically set.

Time

Sets the current time.

① The time is displayed in the 24 hour format.

<<NTP TIME SYNC>>

Synchronizes the internal clock with the time management server.

① To use this function, you need an Internet connection and default gateway settings.

NTP Function (Default: ON)

Automatically obtains the current time from the NTP server.

NTP Server Address (Default: time.nist.gov)

Sets NTP server address.

MENU » SET > **Time Set**

UTC Offset (Default: ±0:00)

Sets the UTC offset time.

CLOCK2 Function (Default: ON)

Selects whether or not to display the second clock on the screen.

CLOCK2 UTC Offset (Default: ±0:00)

Sets the time offset for CLOCK2.

CLOCK2 Name (Default: UTC)

Sets the name of up to 3 characters for CLOCK2.

SD Card

MENU » SET > **SD Card**

Load Setting

Selects the saved data file to load.

Save Setting

Saves the setting data onto an SD card.

SD Card Info

Displays the SD card capacity and the time remaining for voice recording.

Screen Capture View

Displays the selected screen capture.

Firmware Update

Displays the Firmware Update mode.

Format

Formats the SD card.

If you use a brand new SD card, be sure to format it in the transceiver.

Unmount

Unmounts the SD card.

Before you remove a card when the transceiver is ON, be sure to electrically unmount it. Otherwise, the data may be corrupted or deleted.

USB Flash Drive

MENU » SET > USB Flash Drive

Load Setting

Selects the saved data file to load.

Save Setting

Saves the setting data onto a USB flash drive.

USB Flash Drive Info

Displays the USB flash drive capacity.

Screen Capture View

Displays the selected screen capture.

Firmware Update

Displays the Firmware Update mode.

Format

Formats the USB flash drive.

If you use a brand new USB flash drive, be sure to format it in the transceiver.

Unmount

Unmounts the USB flash drive.

Before you remove a flash drive when the transceiver is ON, be sure to electrically unmount it. Otherwise, the data may be corrupted or deleted.

Others

MENU » SET > Others > Information

Version

Displays the transceiver firmware's version number.

MAC Address (LAN)

MAC Address (Controller)

MAC Address (RF Deck)

Displays the MAC address used in this transceiver.

SERIAL NO. (Controller)

SERIAL NO. (RF Deck)

Displays the serial number of the controller or RF deck.

MENU » SET > Others

Touch Screen Calibration

Touch to adjust the touch screen.

① See the Advanced manual for details.

MENU » SET > Others > Reset

Partial Reset

Resets operating settings to their default values (VFO frequency, VFO settings, menu contents).

① See page 10-1 for details.

All Reset

Clears all data and returns all settings to their factory defaults. Memory channel contents, filter setting, and so on will all be cleared, so you will need to rewrite your operating settings.

① See page 10-1 for details.

Setting the date and time

◇ Setting the date

1. Open the “Date” screen.
MENU » **SET > Time Set > Date/Time > Date**
2. Touch [+] or [-] to set the date.
3. Touch [SET] to save the date.

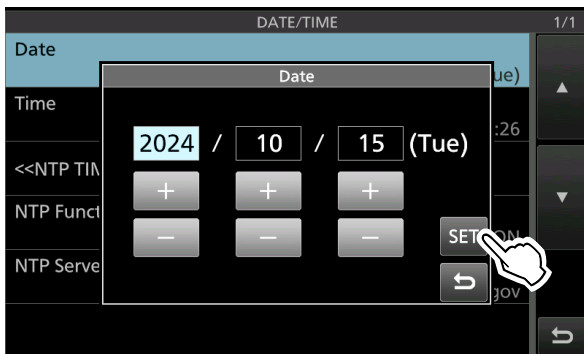

- Returns to the previous screen.
 - ① To cancel the editing, touch **ESC**.
4. To close the DATE/TIME screen, push **EXIT** several times.

◇ Setting the current time

1. Open the “Time” screen.
MENU » **SET > Time Set > Date/Time > Time**
2. Touch [+] or [-] to set the current time.
3. Touch [SET] to save the time.



- Returns to the previous screen.
 - ① To cancel the editing, touch **ESC**.
4. To close the DATE/TIME screen, push **EXIT** several times.

NOTE: The backup battery for the internal clock

The IC-7760 has a lithium backup battery (CR2032) for the internal clock and timer functions. When the backup battery is exhausted, the transceiver normally works but cannot retain the current time. See the Advanced manual for the battery replacement.

◇ Setting the UTC offset

1. Open the “UTC Offset” screen.
MENU » **SET > Time Set > UTC Offset**
2. Touch [+] or [-] to set the UTC offset.
3. Touch **ESC** to save the UTC offset.



- Returns to the previous screen.
4. To close the TIME SET screen, push **EXIT** several times.

TIP: UTC time is displayed under the current time display on the operating screen, only when “CLOCK2 Function” is set to “ON” (default).

◇ Displaying CLOCK2

You can display a different time, such as UTC, or other location. This is convenient when you make QSOs with non-local-time stations. Set the CLOCK2 function ON to display the time on the operating screen. (Default: ON)

1. Open the “CLOCK2 Function” screen.
MENU » **SET > Time Set > CLOCK2 Function**
2. Touch ON or OFF.
 - ON: CLOCK2’s time is displayed under the current time.
 - OFF: CLOCK2’s time is not displayed.

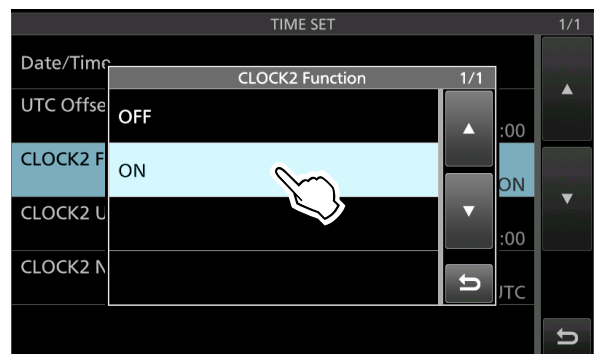

- Returns to the previous screen.

Setting the date and time

◇ Setting the CLOCK2 UTC offset

Set the time offset for CLOCK2 to the same as the current time.

1. Open the “CLOCK2 UTC Offset” screen.
MENU » **SET > Time Set > CLOCK2 UTC Offset**
2. Touch **[+]** or **[-]** to set the UTC offset.
3. Touch **[↵]** to save the UTC offset.

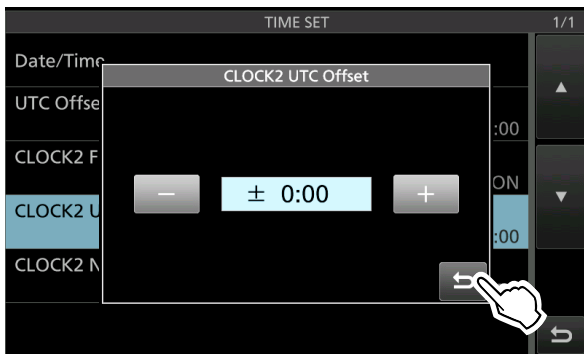

- Returns to the previous screen.
4. To close the TIME SET screen, push **EXIT** several times.

◇ Editing the CLOCK2 name

You can edit CLOCK2's 3 character name. The default name is “UTC.”

1. Open the “CLOCK2 Name” screen.
MENU » **SET > Time Set > CLOCK2 Name**
2. Touch **[CLR]** several times to clear the default name, and then enter the name.
3. Touch **[ENT]** to set the name.



- Returns to the previous screen.
4. To close the TIME SET screen, push **EXIT** several times.

TIP: CLOCK2's time and name are displayed under the current time, only when “CLOCK2 Function” is set to “ON” (default).

Cleaning



DO NOT use harsh solvents such as benzene or alcohol when cleaning, because they will damage the transceiver surfaces.



If the transceiver becomes dusty or dirty, wipe it clean with a dry, soft cloth.

Resetting

Occasionally, erroneous information may be displayed. This may be caused by static electricity or by other factors. If this problem occurs, turn OFF the transceiver. After waiting a few seconds, turn ON the transceiver again.

If the problem still exists, perform a **Partial reset**, as described to the right.

If the problem still exists after a Partial reset, perform an **All reset**, also described to the right.

NOTE: An All reset clears all data and returns all settings to their factory defaults. Save memory channel content, setting status, and so on, onto an SD card or USB flash drive before an All reset.

After performing a Partial reset

A Partial reset resets operating settings to their default values (VFO frequency, VFO settings, menu contents) without clearing the items listed below:

- Pairing information of the controller and RF deck
- Memory channel/Keyer memory/RTTY memory/PSK memory/Preset memory contents
- Network settings
- MY Call
- Fixed Edges
- REF Adjust
- User Band Edges

After performing an All reset

An All reset clears all data and returns all settings to their factory defaults. Memory channel contents, filter settings, and so on will all be cleared, so you will need to directly connect the controller and the RF deck with a supplied control cable to pair them, and then rewrite your operating settings unless you have a backup.

① The internal antenna tuner preset points are not cleared. You can clear them in the following item.

MENU » **SET > Function > Tuner > <<Preset Memory Clear>>**

When you cannot enter the Set mode

If a touch screen operation error or an unexpected operation occurs, you cannot enter the Set mode. In this case, perform an All reset, as described below:

1. Turn OFF the transceiver.
 2. While holding down **(SUB DISP)** and **(MPAD)**, push **(POWER)**.
- ① If you cannot turn the transceiver ON or OFF by using **(POWER)**, perform an All reset by connecting a power adapter while holding down **(SUB DISP)** and **(MPAD)**.

◇ Partial reset

1. Open the RESET screen.
MENU » **SET > Others > Reset**

2. Touch "Partial Reset."

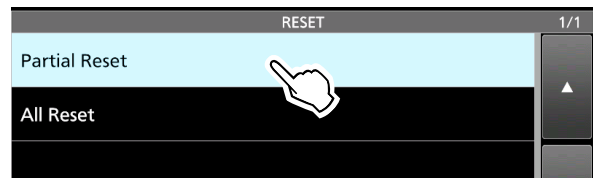

3. Touch [YES].



① After resetting, the default VFO mode screen is displayed.

◇ All reset

1. Open the RESET screen.
MENU » **SET > Others > Reset**

2. Touch "All Reset."

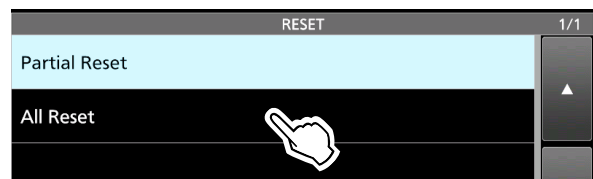

3. Touch [NEXT].



4. After carefully reading the displayed message, touch [YES] to perform the All reset.

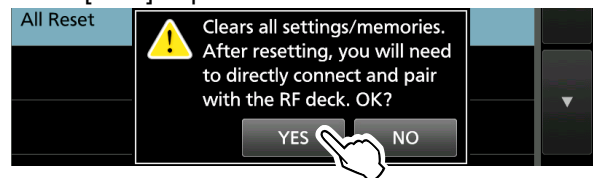

① After resetting, the default VFO mode screen is displayed.

Troubleshooting

The following chart is designed to help you solve problems that are not equipment malfunctions. If you are unable to locate the cause of a problem or solve it through the use of this chart, contact your nearest Icom Dealer or Service Center.

① “AM” indicates the PDF type Advanced manual.

Problem	Possible cause	Solution	REF.
The RF deck's power does not turn ON. (The indicator on the front panel does not light.)	The internal power supply is turned OFF.	Turn ON by pushing [I/O] on the rear panel.	p. 3-1
	The power cable is not properly connected.	Properly reconnect the power cable.	p. 2-2
The controller's power does not turn ON when POWER is pushed.	The power cable is not properly connected.	Properly reconnect the power cable.	p. 2-2
The RF deck's [POWER] indicator lights orange, but does not change to blue.	The controller and RF deck are not paired.	Connect the controller's [RF DECK] and RF deck's [CONTROLLER] with the supplied control cable.	p. 2-2
	The controller's [RF DECK] and RF deck's [LAN] are connected with the supplied control cable.		
	The controller's power is turned OFF.	Turn ON the controller.	p. 3-1
The controller and RF deck cannot be paired.	A user supplied cable is used to connect.	Connect with the supplied control cable.	p. 2-2
	The controller's [RF DECK] and RF deck's [LAN] are connected with the supplied control cable.	Connect the controller's [RF DECK] and RF deck's [CONTROLLER] with the supplied control cable.	p. 2-2
After turning ON the controller, "The RF deck is not detected." is displayed and RF blinks.	The controller and RF deck are not paired because of the first time using, or performing an All reset.	Pair the controller and RF deck.	p. 2-2
No sound is heard from the speaker.	The audio level is too low.	Rotate (AF→RF/SQL) (inner) clockwise to obtain a suitable listening level.	p. 3-1
	The squelch is closed.	Rotate (AF→RF/SQL) (outer) to the 12 o'clock position to open the squelch.	p. 3-8
	If no sound is heard only from the Sub band, the Dualwatch function is OFF.	Turn ON the Dualwatch function.	p. 3-2
	Headphones are connected.	Disconnect the headphones.	–
	A monaural plug is connected to [EXT-KEYPAD].	Disconnected the plug, or use a stereo plug.	p. 13-5
	The Mute function is ON.	Push (AF→RF/SQL) to turn OFF the Mute function on whichever band is selected (Main or Sub).	p. 1-1
Sensitivity is too low, and only strong signals are heard.	The Attenuator is activated.	Turn OFF the Attenuator.	p. 4-1
	RF gain control is set too low. ("RFG" is displayed.)	Set the RF gain higher until "RFG" just goes off.	p. 3-8
	The squelch is closed.	Rotate (AF→RF/SQL) (outer) to the 12 o'clock position to open the squelch.	p. 3-8
	The antenna is defective, or the coaxial cable is defective.	Repair the problem and then reconnect the antenna.	–
	You are using an antenna that is not suitable for the band you have selected.	Connect an antenna suitable for the operating band.	–
	An antenna for another band is selected.	Select an antenna suitable for the operating frequency.	p. 3-9
Some antenna connectors cannot be selected.	The antenna connector is set to "OFF" in the ANT2 ~ ANT4 setting.	Set to "ON."	p. 7-2

Troubleshooting

Problem	Possible cause	Solution	REF.
A receive antenna cannot be select.	“RX-ANT Connectors” is set to “Connect External RX Device.”	Set to “Connect Receive Antenna” (default).	p. 7-2
The MAIN/SUB indicator blinks blue.	The Tracking function is ON.	Turn OFF the function.	AM
The transceiver automatically switches to transmit while receiving.	The VOX function is ON.	Push VOX/BK-IN to turn OFF the VOX function.	AM
	The VOX gain is set too high.	Adjust the VOX gain.	
	The transceiver receives the SEND signal from the software on the PC.	Confirm the “USB SEND” setting.	p. 8-11
The transceiver cannot switch to transmit.	The operating frequency is outside a ham band.	Set the frequency to a ham band.	p. 3-5
	In the CW mode, the Break-in function is turned OFF.	Turn ON the function before starting keying.	p. 4-12
No power output or the output power is too low.	The transmit output power is set too low.	Adjust the RF POWER in the Multi-function menu.	p. 3-10
	The modulation input signal level is set too low.	Adjust the MIC GAIN level in the Multi-function menu.	p. 3-9
	The microphone is bad, or the [MIC] jack is shorted or defective.	Test the microphone and check the [MIC] jack.	p. 13-4
	The antenna SWR is more than 3:1.	Adjust the antenna for an SWR of less than 3:1.	AM
	The antenna is not properly tuned.	Hold down TUNER for 1 second to tune the antenna.	p. 7-3
The transmit signal is unclear or distorted in the SSB mode.	The transceiver’s microphone gain is too high.	Adjust the MIC GAIN level so that the meter reading swings between 30 and 50% of the ALC scale.	p. 3-9
Under modulation occurs.	In the AM or FM mode, the transceiver’s microphone gain is too low.	Adjust the MIC GAIN level in the Multi-function menu.	p. 3-9
	In the AM mode, the transceiver’s Drive Gain level is too high.	Adjust the Drive Gain level.	AM
The received audio in the SSB mode is unclear or distorted.	The incorrect sideband is selected.	Toggle between USB and LSB.	p. 3-4
	The PBT function is activated.	Hold down TWIN PBT CLR for 1 second to clear the PBT settings.	p. 4-4
Cannot contact with another station, even if receiving and transmitting seem normal.	The Split function is ON, and the transmit and receive frequencies differ. (SPLIT is displayed.)	Push SPLIT to turn OFF the Split function.	p. 4-10
	The RIT or ΔTX function is ON, and the transmit and receive frequencies differ. (“RIT” or “ΔTX” is displayed.)	Push RIT or ΔTX to turn OFF the function.	p. 4-1, AM
The frequency is not properly changed by rotating RIT/ΔTX .	The RIT or ΔTX function is OFF.	Push RIT or ΔTX to turn ON the function.	p. 4-1, AM
The operating frequency does not change when rotating MAIN DIAL .	The Dial Lock function is ON.	Hold down SPEECH to turn OFF the Dial Lock function.	p. 3-9
The display turns OFF.	The Screen Saver function is ON. (The indicator on NR blinks white.)	Operate something (push key, and so on) to reset the screen saver startup time.	p. 8-16
A Programmed scan does not start.	The VFO mode is not selected.	Select the VFO mode.	p. 3-1
	The same frequencies have been set in the scan edge memory channels P1 and P2.	Set different frequencies in scan edge memory channels P1 and P2.	AM

Troubleshooting

Problem	Possible cause	Solution	REF.
A Memory scan does not start.	The Memory mode is not selected.	Select the Memory mode.	p. 3-1
	No, or only 1 memory channel is set.	Set at least 2 memory channels.	AM
A Select memory scan does not start.	No, or only 1 memory channel is assigned as a Select channel.	Assign at least 2 memory channels as Select channels for the scan.	AM
While operating in the Memory mode, you changed the operating frequency, mode, and so on, but a selected memory channel contents are not changed.	They were not overwritten already in the selected memory.	When you want to save the changed settings, touch [MW] for 1 second to write them into the memory channel on the VFO/MEMORY screen.	AM
Cannot hear the speech after pushing SPEECH .	The speech level is too low.	Adjust "SPEECH Level" in the Speech setting.	p. 8-5
"OVF" is displayed.	An excessively strong signal is being received.	Set the RF gain lower. ("RFG" is displayed.)	p. 3-8
		Turn ON the Attenuator.	p. 4-1
		Turn ON the Digital Selector function.	p. 4-9
		Turn OFF the Preamplifier.	p. 4-1
The spectrum scope's sensitivity is too low, and no signal or only strong signals are displayed.	The reference level is too low.	Set the reference level to a higher level.	AM
	When the Dualwatch is OFF, the spectrum scope of the Sub band is displayed.	Touch [MAIN/SUB] to display the spectrum scope of the Main band.	p. 5-1
Cannot transmit voice memories.	"DATA OFF MOD" is set to "USB," "LINE-IN," "ACC," or "LAN" by control from an external device, and so on.	Set "DATA OFF MOD" to "MIC,USB,ACC" (default).	p. 8-11
The antenna SWR is too high.	The antenna is not properly tuned.	Adjust the antenna SWR. The antenna SWR should be less than 3.	–
	The coaxial cable is not suitable.	Use a coaxial cable whose characteristic impedance is 50 Ω.	–
	An antenna for another band is selected.	Select an antenna suitable for the operating frequency. ① When using an external antenna tuner, set "External Antenna Tuner Connection" to the antenna connector connected to the antenna tuner.	pp. 3-9, 7-2
The indicator on VOX/BK-IN does not light.	Other than "VOX/BK-IN" is assigned to VOX/BK-IN .	Set "[VOX/BK-IN]" to "VOX/BK-IN."	p. 8-6
"No SD Card is found." is displayed.	An SD card is not recognized.	Confirm that an SD card is inserted.	p. 6-1
		Reinsert an SD card.	
		Exchange with a new SD card.	
"No USB Flash Drive is found." is displayed.	A USB flash drive is not recognized.	Confirm that a USB flash drive is inserted.	p. 6-1
		Reinsert a USB flash drive.	
		Exchange with a new USB flash drive.	
Cannot save TX/RX histories or sound data.	An SD card is not inserted.	Insert an SD card. ① You cannot save TX/RX histories or sound data onto a USB flash drive.	p. 6-1
Not the voice memory data, but the Instant Replay memory data is played back.	You push PLAY to play back an audio.	To play back the voice memory data, open the VOICE PLAYER screen.	AM

Troubleshooting

Problem	Possible cause	Solution	REF.
“– No File –” is displayed on the FIRMWARE UPDATE screen.	The firmware file is in an incorrect folder.	Copy the firmware file into the IC-7760 folder.	AM
	The firmware file name is different.	Download the firmware file again.	
	The SD card or USB flash drive is not formatted.	Format the SD card or USB flash drive.	p. 6-2
The touch screen is not working correctly.	The touched point and the detected point may be different.	Calibrate the touch screen on the OTHERS screen.	AM
The current time is reset.	The lithium backup battery in the controller is exhausted.	Replace the lithium backup battery.	AM
Even when turning ON the NTP function, the clock is not automatically set.	The transceiver is not connected to a network.	Connect an ethernet cable to the RF deck's [LAN] port.	AM
		Confirm the network settings.	p. 8-14, AM
	The transceiver IP address is incorrect.	Turn ON the DHCP function to automatically get the IP address, or set the correct IP address.	p. 8-14
The Timer function does not work.	The Timer function is OFF. (The indicator on TIMER does not light.)	Push TIMER to turn ON the function.	AM
	The Timer settings is not set.	Set the Timer settings.	AM
	“Timer Status” is set to “OFF.”	Set to “ON.”	AM
The Daily Timer function does not work.	The current time is reset.	Set the current time.	p. 9-1
“The IP address settings are incorrect” is displayed, and “Error” is displayed to the left of the IP address setting.	The IP address settings are duplicated.	Set different IP addresses to each IP address setting.	p. 8-14
	The network part of the IP addresses are different between each setting.	Set the same network part to all IP address settings.	p. 8-14
The audio is intermittent.	The controller and RF deck are directly connected with a user supplied cable.	Connect with the supplied control cable.	p. 2-2
	When the controller and RF deck are connected through a network, a network switch or Ethernet cable is not compatible with Gigabit Ethernet.	Use a network switch and Ethernet cable that is compatible with Gigabit Ethernet.	AM
	When the controller and RF deck are connected through a network, the audio buffer's capacity is not enough.	Change the “Audio Buffer Size (via LAN)” setting. When the controller and RF deck are on different segments, change the “Audio Buffer Size” setting in the “Different Segment Settings” menu.	p. 8-14
	The internal reference frequency has shifted.	Adjust the internal reference frequency in “REF Adjust.”	AM
Another network part cannot be set to “IP Address (RF Deck).”	“Connection from Different Segment” is set to “OFF.”	Set this item to “ON,” and then set the items in the “Different Segment Settings” menu.	p. 8-14
The controller and RF deck cannot be connected between different segments.	The network switch settings are incorrect.	Check the network switch settings. ① They cannot be connected through the Internet.	AM
“The connection to the RF deck has been lost” is repeatedly displayed.	–	Contact your nearest Icom Dealer or Service Center.	–

◇ General

- Frequency coverage (unit: MHz):

Receiver	0.030000 ~ 60.000000
Transmitter	0.135700 ~ 0.137800* ¹ (Only in the European version)
	1.800000 ~ 1.999999* ²
	3.500000 ~ 3.999999* ²
	5.255000 ~ 5.405000 (Only in the USA version)
	7.000000 ~ 7.300000* ²
	10.100000 ~ 10.150000
	14.000000 ~ 14.350000
	18.068000 ~ 18.168000
	21.000000 ~ 21.450000
	24.890000 ~ 24.990000
	28.000000 ~ 29.700000
	50.000000 ~ 54.000000*

*¹ Outputs from [X-VERTER].
*² The frequency coverage and guaranteed ranges differ, according to the transceiver version.
- Operating modes: USB/LSB (J3E), CW (A1A), RTTY (F1B), PSK (G1B), AM (A3E), and FM (F3E)
- Number of memory channels: 101 channels (including 2 scan edges)
- Antenna impedance: 50 Ω unbalanced (When the antenna tuner is OFF)
- Antenna connector: SO-239 (50 Ω) × 4 (for the HF/50 MHz band)
BNC × 1 (for the HF/50 MHz band, RX only)
- Power source requirement:

RF deck	90 ~ 264 V AC (50 Hz/60 Hz)
Controller	15.0 V DC ±0.75 V (Polarity: ⊖—⊕)
- Operating temperature range: 0°C ~ 50°C, 32°F ~ 122°F
- Frequency stability: ±0.5 ppm or less (0°C ~ 50°C, 32°F ~ 122°F)
- Frequency resolution: 1 Hz
- Power consumption:

Receive	Standby	150 VA (typical)
	Maximum audio	150 VA (typical)
Transmit	Maximum power	800 VA (maximum)

① Includes the controller (Receive Maximum audio: 3 A (maximum, at 15 V DC))
- Dimensions (projections not included):

RF deck	425 (W) × 149 (H) × 442 (D) mm, 16.7 (W) × 5.9 (H) × 17.4 (D) in
Controller	340 (W) × 118 (H) × 103.5 (D) mm, 13.4 (W) × 4.6 (H) × 4.1 (D) in
- Weight (approximate, without the supplied accessories):

RF deck	15.8 kg, 34.8 lb
Controller	2.3 kg, 5.1 lb

◇ Transmitter

- Transmit output power:

SSB/CW/FM/RTTY/PSK	1 ~ 200 W
AM	0.25 ~ 50 W
- Modulation system:

SSB	Digital PSN modulation
FM	Digital Reactance modulation
AM	Digital Low power modulation
- Spurious emission:

Unwanted emission	More than 50 dB (HF band)
	More than 66 dB (50 MHz band)
Out-of-band emission	More than 40 dB (HF band)
	More than 60 dB (50 MHz band)
- Carrier suppression: More than 50 dB
- Unwanted sideband suppression: More than 50 dB
- Microphone impedance: 600 Ω

11 SPECIFICATIONS

◇ Receiver

- Receive system: RF Direct Sampling Super Heterodyne
- Intermediate frequency: 1st 12 kHz
- Sensitivity:
 - SSB/CW (BW=2.4 kHz, at 10 dB S/N)
 - 135/475 kHz band +3 dB μ V (1.41 μ V) typical
 - 1.800000 ~ 29.999999 MHz -16 dB μ V (0.16 μ V) typical
 - 50 MHz band -18 dB μ V (0.13 μ V) typical
 - AM (BW=6 kHz, at 10 dB S/N)
 - 0.500000 ~ 1.799999 MHz +16 dB μ V (6.3 μ V) typical
 - 1.800000 ~ 29.999999 MHz +6 dB μ V (2.0 μ V) typical
 - 50 MHz band 0 dB μ V (1.0 μ V) typical
 - FM (BW=15 kHz, at 12 dB SINAD)
 - 28.000000 ~ 29.700000 MHz -6 dB μ V (0.5 μ V) typical
 - 50 MHz band -10 dB μ V (0.32 μ V) typical
- ① P.AMP1 is ON in the HF band, and P.AMP2 is ON in the 50 MHz band.
- Sensitivity for the European version (Filter: SOFT):
 - SSB/CW (BW=2.4 kHz, at 12 dB SINAD)
 - 1.800000 ~ 2.999999 MHz Less than +10 dB μ V emf
 - 3.000000 ~ 29.999999 MHz Less than 0 dB μ V emf
 - 50 MHz band Less than -6 dB μ V emf
 - AM (BW=4 kHz, 60% Modulation, at 12 dB SINAD)
 - 1.800000 ~ 2.999999 MHz Less than +16 dB μ V emf
 - 3.000000 ~ 29.999999 MHz Less than +6 dB μ V emf
 - 50 MHz band Less than 0 dB μ V emf
 - FM (BW=7 kHz, 60% Modulation, at 12 dB SINAD)
 - 28.000000 ~ 29.700000 MHz Less than 0 dB μ V emf
 - 50 MHz band Less than -6 dB μ V emf
- ① P.AMP1 is ON in the HF band, and P.AMP2 is ON in the 50 MHz band.
- Selectivity (Filter: SHARP):
 - SSB (BW=2.4 kHz) More than 2.4 kHz/-6 dB
Less than 3.6 kHz/-60 dB
 - CW (BW=500 Hz) More than 500 Hz/-6 dB
Less than 700 Hz/-60 dB
 - RTTY (BW=500 Hz) More than 500 Hz/-6 dB
Less than 700 Hz/-60 dB
 - AM (BW=6 kHz) More than 6.0 kHz/-6 dB
Less than 15.0 kHz/-60 dB
 - FM (BW=15 kHz) More than 12.0 kHz/-6 dB
Less than 20.0 kHz/-60 dB
- Spurious and image rejection:
 - SSB/CW/AM/FM
 - HF band More than 70 dB
 - 50 MHz band More than 70 dB (except for ADC aliasing:
122.880 MHz - RX frequency)
- Audio output power: More than 2.0 W (8 Ω load, 10% distortion)
- AF output impedance: 8 Ω
- RIT variable range: \pm 9.999 kHz
- ANF attenuation: More than 30 dB (with 1 kHz single tone)
- NR attenuation: More than 6 dB (noise rejection in SSB)

◇ Antenna tuner

- Tunable impedance range: 16.7 ~ 150 Ω (unbalanced) (1:3 VSWR or less)
- Tuning accuracy: 1:1.5 VSWR or less
- Tuning time (approximate): 2 ~ 3 seconds (average)
15 seconds (maximum)

① All stated specifications are typical and subject to change without notice or obligation.

Options

(As of October 2024)

IC-PW2
LINEAR AMPLIFIER



SP-41
EXTERNAL SPEAKER



HM-219
MICROPHONE



SM-30
DESKTOP MICROPHONE



Desktop microphone with a low frequency cut function.

SM-50
DESKTOP MICROPHONE



Dynamic microphone with [UP]/[DOWN] switches.

AH-730
AUTOMATIC ANTENNA TUNER



Set "External Antenna Tuner Connection" to the antenna connector to which the AH-730 is connected.

RC-28
REMOTE ENCODER



For operating the RS-BA1 (version 1.3 or later) or using as a sub dial to operate the transceiver.

SP-33 EXTERNAL SPEAKER

BC-267A/BC-267E POWER ADAPTER

The same as supplied.

RS-BA1 Version 2 IP REMOTE CONTROL SOFTWARE

NOTE: To remotely control transceivers using the RS-BA1 software, **BE SURE** to comply with your local regulations.

13 CONNECTOR INFORMATION

RF Deck

◇ ACC sockets

Connect to devices to control an external unit or to control the transceiver.

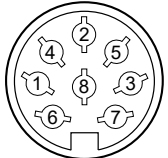
ACC 1	Pin No.	Name	Description	Specifications
 <p>8-pin Rear panel view</p>	1	RTTY	Controls RTTY keying.	High level: More than 2.4 V Low level: Less than 0.6 V Output current: Less than 2 mA
	2	GND	Connects to ground. Connected in parallel with ACC 2 pin 2.	
	3	SEND	Input/output pin. Connected in parallel with ACC 2 pin 3. An external unit controls the transceiver. When this pin goes to ground, the transceiver transmits. The pin goes low when the transceiver transmits.	Input voltage (RX): 2.0 ~ 20.0 V Input voltage (TX): -0.5 ~ +0.8 V Current flow: Less than 20 mA Output voltage (TX): Less than 0.1 V Current flow: Less than 200 mA
	4	MOD	Modulator input. Connects to the internal modulator circuit.	Input impedance: 10 kΩ Output level: 100 mV rms*2
	5	AF/IF 12k*3	Fixed AF detector or receive IF (12 kHz) signal output.	Output impedance: 4.7 kΩ Output level: 100 ~ 300 mV rms*4
	6	SQL S	Squelch output. Grounded when the squelch opens.	SQL open: Less than 0.3 V/5 mA SQL closed: More than 6.0 V/100 μA
	7	15 V	15 V output when power is ON. Connected in parallel with ACC 2 pin 7.	Output current: Less than 1A
	8	ALC	ALC voltage input. Connected in parallel with ACC 2 pin 5.	Input impedance: 10 kΩ Input level: -4 ~ 0 V

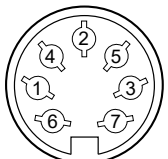
ACC 2	Pin No.	Name	Description	Specifications
 <p>7-pin Rear panel view</p>	1	8 V	Regulated 8 V output.	Output voltage: 8 V ±0.3 V Output current: Less than 10 mA
	2	GND	Connects to ground. Connected in parallel with ACC 1 pin 2.	
	3	SEND*1	Same as ACC 1 pin 3.	
	4	BAND	Band voltage output. (Varies with the selected amateur band)	Output voltage: 0 ~ 8.0 V
	5	ALC	Same as ACC 1 pin 8.	
	6	TRV	Activates [X-VERTER] input/output when "HIGH" voltage is applied.	Input impedance: More than 10 kΩ Input voltage: 2 ~ 15 V
	7	15 V	Same as ACC 1 pin 7.	

*1 When the SEND terminal controls an inductive load, such as a relay, a counter-electromotive force can malfunction or damage the transceiver. To prevent this, we recommend adding a switching diode, such as a 1SS133, on the load side of the circuit to absorb the counter-electromotive force.
① When the diode is added, a delay in relay switching may occur. Be sure to check its switching action before operating.

Example: ACC 1/2 socket

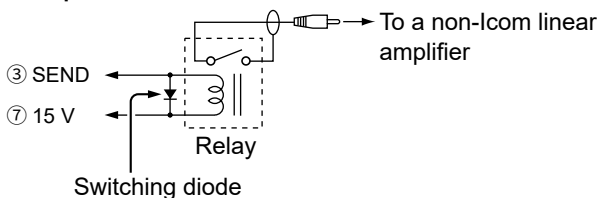

*2 You can change the MOD input level.
① 100 mV rms is at 50% as the default.

MENU » SET > Connectors > MOD Level > **ACC MOD Level**

*3 You can change the AF/IF (IF=12 kHz) settings to output a 12 kHz IF signal. In that case, you can listen to DRM communication with the application software receiver that is installed onto your PC.

MENU » SET > Connectors > ACC AF/IF Output > **Output Select**

*4 You can change the AF/IF (IF=12 kHz) output level.
① Approximately 200 mV rms is at 50% as the default.

MENU » SET > Connectors > **ACC AF/IF Output**

RF Deck

◇ [ANT 1]/[ANT 2]/[ANT 3]/[ANT 4]

Connect an antenna for the HF and 50 MHz bands.

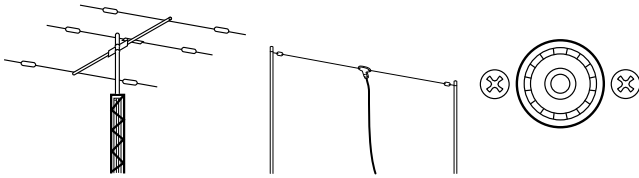

- Input/Output impedance: 50 Ω (unbalanced)
- Connector type: SO-239

① When using an external antenna tuner, set “External Antenna Tuner Connection” to the antenna connector connected to the antenna tuner.

MENU » ANTENNA > TYPE >
External Antenna Tuner Connection

◇ [X-VERTER]

Outputs HF frequency signals for Transverter operation.

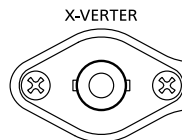

- Input/Output impedance: 50 Ω (unbalanced)
- Output signal level: More than -20 dBm
- Connector type: BNC

① Set the following item to “ON” to use the transverter operating mode.

MENU » SET > Function > **Transverter Function**

- You cannot select the antenna or use the internal antenna tuner while the Transverter function is ON.

① Set the offset frequency for the transverter operation.

MENU » SET > Function > **Transverter Offset**

◇ [REF IN]

Inputs a 10 MHz signal as a reference frequency signal.

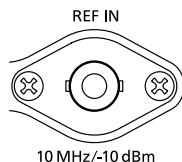

10 MHz/-10 dBm

- Input frequency: 10 MHz
- Impedance: 50 Ω (unbalanced)
- Input level: -10 dBm (approximate)
- Connector type: BNC

① Select the transceiver’s reference signal source.

MENU » SET > Connectors > **REF IN**

① You can adjust the internal reference frequency.

MENU » SET > Function > **REF Adjust**

◇ [RX-ANT IN]/[RX-ANT OUT]

Connect a receive antenna to [RX-ANT IN], and a receiver to [RX-ANT OUT].

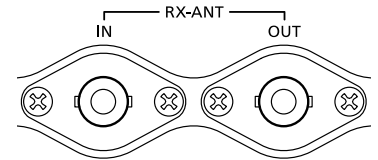

- Input/Output impedance: 50 Ω (unbalanced)
- Connector type: BNC

Signal is directly received through [RX-ANT IN], instead of the antenna connector.

You can also connect an external preamp or filter, as shown below.

① In this case, set the antenna connector to between “ANT 1/R” and “ANT 4/R.” (p. 7-1)

Example

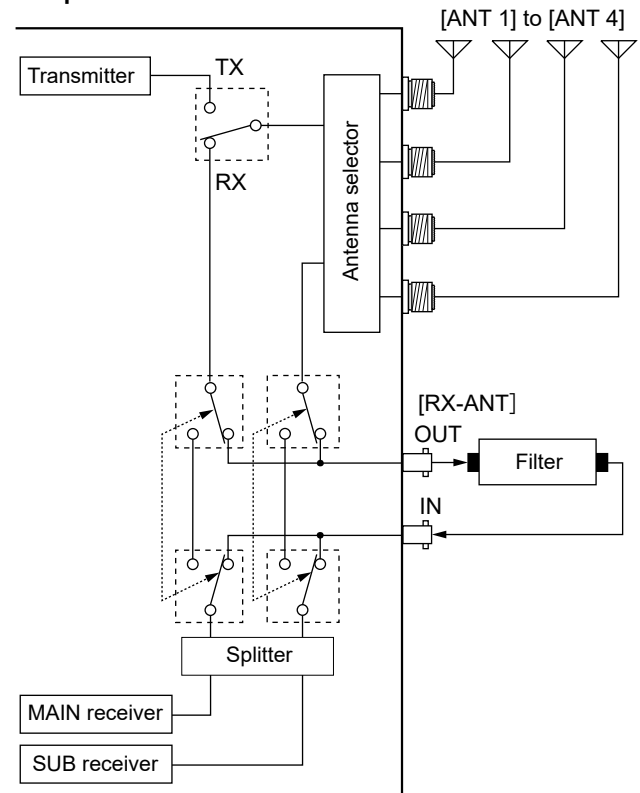

◇ [REMOTE]

Connect to an external equipment for remote control.

3.5 mm (1/8 inch)

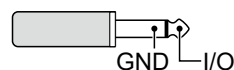

13 CONNECTOR INFORMATION

RF Deck

◇ [TUNER]

Connect the control cable to an optional AH-730 automatic antenna tuner. (p. 2-2)

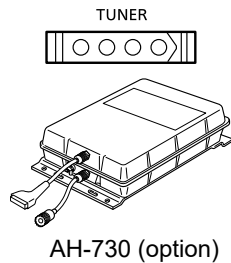

◇ [CONTROLLER]

Connect to the controller with the supplied control cable.

① **DO NOT** connect to 2 or more controllers, or other devices.

About the LED indication

① LINK/ACT

- Lights green when a cable is connected.
- Does not light when a cable is not connected.
- Blinks green while communicating.

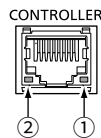

- ##### ②
- Lights green when a cable is connected.
 - Does not light when a cable is not connected.

◇ [LAN]

- Connecting to the controller through a network.
- Time synchronization by an NTP server.
- Outputting the demodulated AF signal or 12 kHz IF signal.
- Remotely controlling using optional RS-BA1 software.

① You can select the output signal from AF and IF signals.

MENU » SET > Connectors > LAN AF/IF Output

About the LED indication

① LINK/ACT

- Lights green when a cable is connected.
- Does not light when a cable is not connected.
- Blinks green while communicating.

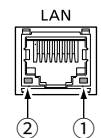

② Speed

- Lights green while communicating in 1000BASE-T.
- Does not light while communicating in 10BASE-T/100BASE-TX, or when a cable is not connected.

◇ [KEY]

Connect to a straight key or external electronic keyer.

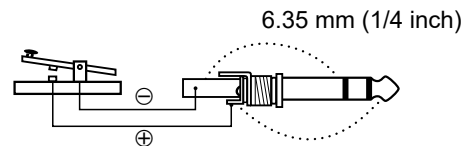

◇ [ALC]

Inputs ALC voltage to the jack when operating with a non-Icom linear amplifier.

- ALC voltage: -4 ~ 0 V

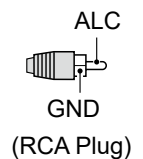

◇ [SEND]

This terminal is used to control an external equipment such as a non-Icom linear amplifier.

The terminal goes low when the transceiver transmits.

① The T/R switching relay type can be changed on the following item.

MENU » SET > Connectors > SEND Relay Type

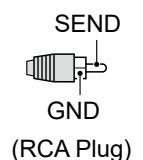

◇ [USB] (for I/Q output)

Use the USB (3.0/3.1/3.2) Type-B port to output the Phase/Quadrature data which is processed by the FPGA.

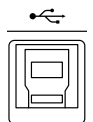

Connect a PC's USB port, to demodulate the DRM broadcast or Software Defined Radio SDR.

① Icom does not provide any support regarding SDR technology and related software, except the inspection for the normality of output signal.

① You can download the IQ driver and instruction guide from the Icom website.

<https://www.icomjapan.com/support/>

◇ [AC]

Connect the supplied power cable to an AC receptacle.

- Power source requirement:
90 ~ 264 V AC
(Single-phase, 50 Hz/60 Hz)

① Only the power cable supplied with the EUR version can be used to connect to a 180 ~ 264 V AC power source. For other versions, use a power cable that matches the power source if you connect to a 180 ~ 264 V AC power source.

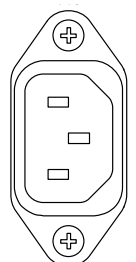

Controller

◇ [MIC]

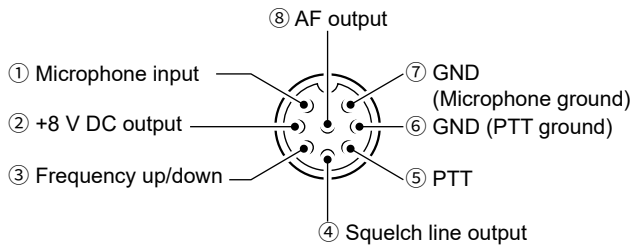

NOTE: Pin 1 outputs 8 V DC power for Icom microphones.

① You can turn OFF the DC power when you use non-Icom microphones the following item.

MENU » **SET > Connectors > MIC Input DC Bias**

Pin No.	Description
①	Microphone input
②	+8 V DC output (Maximum 10 mA)
③	Frequency up/down
④	Grounded when squelch opens.
⑤	PTT*
⑥	PTT ground
⑦	Microphone ground
⑧	AF output (varies with the AF control.)

* To output SEND signal from the PTT pin, set "PTT Port Function" to "PTT Input + SEND Output."

MENU » **SET > Connectors > PTT Port Function**

By connecting an external keypad to [MIC] with a circuit as shown below, you can send the content from one of 4 memories. You can send the content from a CW Keyer Memory (M1 ~ M4), SSB/AM/FM Voice Memory (T1 ~ T4), RTTY Memory (RT1 ~ RT4), or PSK Memory (PT1 ~ PT4) to be transmitted.

- Push a switch to send the memory content.
- Hold down the switch for 1 second to repeatedly send the memory content.

① To use the external keypad, turn ON the following item.

MENU » **SET > Connectors > External Keypad**

① The external keypad shown below is not supplied by Icom.

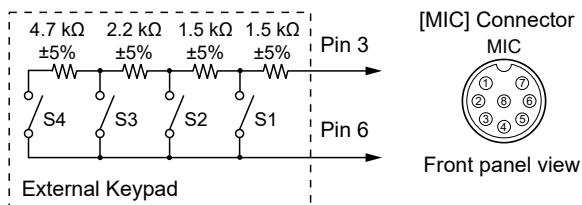

◇ [PHONES]

Connect to standard stereo headphones:

- Output impedance: 8 ~ 16 Ω
- Output level: More than 5 mW (8 Ω load)

3.5 mm (1/8 inch)

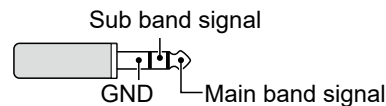

- ① While headphones are connected, both the internal and external speakers are deactivated.
- ① If you use headphones with high impedance, the output audio may be too loud.
- ① You can change the output setting in the following item.

MENU » **SET > Connectors > Phones**

◇ [RF DECK]

Connect to the RF deck with the supplied control cable or through a LAN.

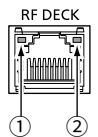

About the LED indication

- When connecting to [CONTROLLER] on the RF deck:

① LINK/ACT

- Lights green when a cable is connected.
- Does not light when a cable is not connected.
- Blinks green while communicating.

②

- Lights green when a cable is connected.
- Does not light when a cable is not connected.

- When connecting to a network:

① LINK/ACT

- Lights green when a cable is connected.
- Does not light when a cable is not connected.
- Blinks green while communicating.

② Speed

- Lights green while communicating in 1000BASE-T.
- Does not light while communicating in 10BASE-T/100BASE-TX, or when a cable is not connected.

◇ [EXT-DISPLAY]

Connect an external display monitor to mirror the Main screen.

Outputs the digital RGB signal.

① Set the external display settings in the following item.

MENU » **SET > Display > External Display**

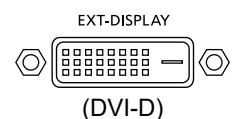

13 CONNECTOR INFORMATION

Controller

◇ [USB A]

Use the USB (1.1/2.0) Type-A port for connecting a keyboard, RC-28 REMOTE ENCODER, USB flash drive, mouse, or hub.

- ① Turn OFF the transceiver when connecting or disconnecting.



NOTE:

- **DO NOT** connect a multimedia adapter, memory card reader, USB HDD, or Bluetooth keyboard or mouse, as these are not supported by Icom.
- **DO NOT** connect two or more of the same USB devices. (Example: Two USB hubs or two USB mice)

- ① Connect a keyboard for the RTTY and PSK operations.

By connecting a keyboard to [USB], you can send the content from one of 4 memories. You can send the content from a CW Keyer Memory (M1 ~ M8), SSB/AM/FM Voice Memory (T1 ~ T8), RTTY Memory (RT1 ~ RT8), or PSK Memory (PT1 ~ PT8) to be transmitted.

- ① To use this function, turn ON the following items.

MENU » SET > Connectors > Keyboard/Mouse > Keyboard [F1]-[F8] (VOICE)

MENU » SET > Connectors > Keyboard/Mouse > Keyboard [F1]-[F8] (KEYER)

◇ [USB B]

Use the USB (1.1/2.0) Type-B port for:

- Outputting decoded RTTY data.
- Outputting a demodulated AF signal or 12 kHz IF signal.
- Inputting an AF modulation signal.
- Interface for remote control using CI-V commands.
- Remotely controlling using optional RS-BA1 software.



- ① You can change the signal output type and output level.

MENU » SET > Connectors > USB AF/IF Output

- ① You can download the USB driver and installation guide from the Icom website.

<https://www.icomjapan.com/support/>

◇ [EXT-KEYPAD]

By connecting an external keypad to [EXT-KEYPAD] with a circuit as shown below, you can send the content from one of the 8 memories. You can send the content from a CW Keyer Memory (M1 ~ M8), SSB/AM/FM Voice Memory (T1 ~ T8), RTTY Memory (RT1 ~ RT8), or PSK Memory (PT1 ~ PT8) to be transmitted.

- Push a switch to send the memory content.
- Hold down the switch for 1 second to repeatedly send the memory content.

- ① To use the external keypad, turn ON the following item.

MENU » SET > Connectors > External Keypad

- ① The external keypad shown below is not supplied by Icom.

Mute switch: Mutes both transmission and reception when the switch is turned ON.

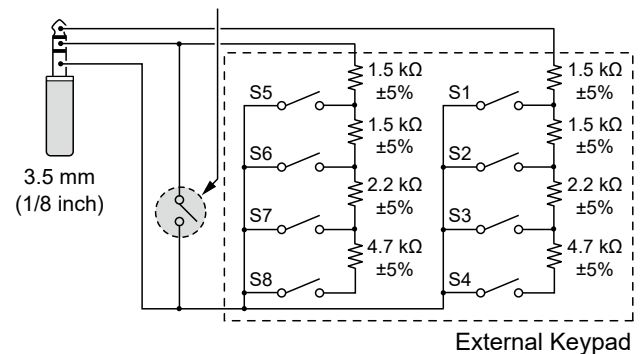

◇ [ELEC-KEY]

Connect a Paddle key to activate the internal electronic keyer for CW operation.

- ① You can select the key type.

MENU » SET > CW-KEY SET > Key Type

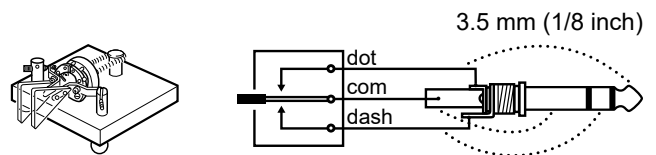

Controller

◇ [SEND]

An external unit controls the transceiver. When the SEND pin goes to ground, the transceiver transmits.



- Input voltage (RX): 2.0 to 20.0 V
- Input voltage (TX): -0.5 to +0.8 V
- Current flow: Maximum 20 mA

The pin goes low when the transceiver transmits.

- Output voltage (TX): Less than 0.1 V
 - Current flow: Maximum 200 mA
- ① You can also use ACC 1 and ACC 2 pin 3 on the RF deck to control the transceiver using an external unit.

When the SEND terminal controls an inductive load, such as a relay, a counter-electromotive force can malfunction or damage the transceiver. To prevent this, we recommend adding a switching diode, such as a 1SS133, on the load side of the circuit to absorb the counter-electromotive force.

- ① When the diode is added, a delay in relay switching may occur. Be sure to check its switching action before operating.
- ① Be sure to connect the Negative terminal of the Power source for Relay to the [SEND] jack's GND terminal.

Example: [SEND] jack

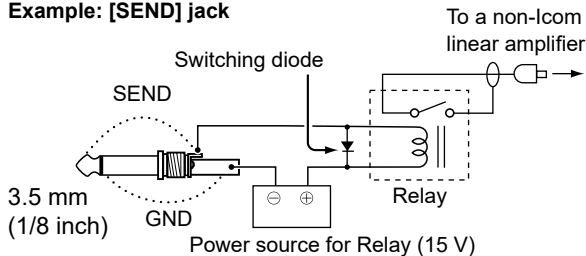

◇ [LINE IN]/[LINE OUT]

[LINE IN]

Inputs the audio signal to the internal modulator circuit. (3.5 mm (1/8 inch))

- Impedance: 10 k Ω
- Output level: 100 mV rms*1

- *1 You can change the MOD input level.
① 100 mV rms is at 50% as the default.

MENU » SET > Connectors > MOD Input > **LINE-IN MOD Level**

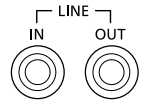

- ① You can also use ACC 1 pin 4 on the RF deck to input the audio signal.

[LINE OUT]

Outputs the demodulated AF signal or 12 kHz IF signal. (3.5 mm (1/8 inch))

- Output impedance: 4.7 k Ω
- Output level: 100 ~ 300 mV rms*2

- *2 You can change the AF/IF (IF=12 kHz) output level.
① Approximately 200 mV rms is at the 50% as the default.

MENU » SET > Connectors > **LINE-OUT AF/IF Output**

- ① You can change the AF/IF (IF=12 kHz) settings to output a 12 kHz IF signal. In that case, you can listen to DRM communication with the application software receiver that is installed onto your PC.

MENU » SET > Connectors > LINE-OUT AF/IF Output > **Output Select**

- ① You can also use ACC 1 pin 5 on the RF deck to output the demodulated AF signal or 12 kHz IF signal.

13 CONNECTOR INFORMATION

Controller

◇ [EXT-SP A]/[EXT-SP B]

Connect to external speakers.

(3.5 mm (1/8 inch))

- Output impedance: 4 ~ 8 Ω
- Output level: More than 2 W
(8 Ω load, 10% distortion)

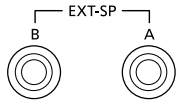

◇ [DC IN]

Connect the supplied power cable to an AC receptacle.

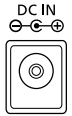

About audio output settings

(When [PHONES] is not in use)

Speaker MAIN/SUB Mix: OFF				
Output Connection	Output from the internal speaker		Output from the external speaker	
	L	R	EXT-SP A	EXT-SP B
Internal speaker only	MIX*	MIX*	N/C	N/C
External speaker (A + B)	OFF	OFF	MAIN	SUB
External speaker (A)	OFF	SUB	MAIN	N/C
External speaker (B)	MAIN	OFF	N/C	SUB

Speaker MAIN/SUB Mix: ON				
Output Connection	Output from the internal speaker		Output from the external speaker	
	L	R	EXT-SP A	EXT-SP B
Internal speaker only	MIX	MIX	N/C	N/C
External speaker (A + B)	OFF	OFF	MIX	MIX
External speaker (A)	OFF	OFF	MIX	N/C
External speaker (B)	MIX	OFF	N/C	MIX

MIX: Outputs the audio from both Main and Sub bands.

① You can change the setting in the following item.

MENU » **SET > Function > Speaker MAIN/SUB Mix**

- * When Dualwatch is ON, the internal speaker L outputs the audio from the Main band, and R outputs the audio from the Sub band.

1/4 Tuning function3-5

A

AGC function4-2

AH-730 2-2, 7-4

All reset10-1

Antenna

 Memory screen7-1

 Type7-2

APF (Audio Peak Filter).....4-13

Attenuator4-1

Audio scope5-2

Auto Tuning Step function3-5

B

Band Stacking Register3-3

Break-in function4-12

C

Cleaning10-1

Clock

 Current time9-1

 Date9-1

 UTC offset9-1

CLOCK2 8-17, 9-1

Connectors (Set mode)8-9

CW

 Pitch control4-11

 Side tone4-12

CW-KEY Set (Set mode)8-2

D

Data mode3-4

Dial Lock function3-9

DIGI-SEL4-9

Digital Twin PBT4-4

Display

 Main screen1-5

 Sub screen1-10

Display (Set mode)8-16

DPD (Digital Pre-Distortion) function4-9

Dualwatch3-2

E

Electronic Keyer function4-13

Entering and editingv

F

Filter

 IF filter4-5

 Notch Filter4-6

 Transmit filter width4-8

Fine Tuning function3-5

Frequency

 Directly entering3-6

 Using the Main Dial3-5

FUNCTION screen1-7

Function (Set mode)8-3

G

Grounding2-1

I

IC-PW2 2-3, 7-4

K

Keyboard

 Entering and editingv

 Keyboard typev, 8-7

M

Main band3-2

Main screen1-5

Memory mode3-1

MENU screen1-7

Meter3-11

Microphone gain3-9

Monitor function4-8

Multi-function dial1-9

Multi-function key group1-8

Multi-function menu1-8

N

Network (Set mode)8-14

Noise Blanker4-7

Noise Reduction4-7

Noise squelch3-8

O

Operating band3-3

Operating mode3-4

Options12-1

Oscilloscope5-2

Others (Set mode)8-18

P

Partial reset10-1

Power ON or OFF3-1

Preamplifiers4-1

Q

QUICK MENU1-7

Quick Split function4-10, 8-4

R

Resetting10-1

RF gain3-8

RIT function4-1

S

SD card6-1

SD Card (Set mode)8-17

S-meter squelch3-8

Spectrum scope

 Marker5-2

 Mini scope screen5-2

Speech Compressor4-3

Split frequency operation4-10

Split Lock function4-11, 8-5

SQL level3-8

Squelch3-8

Sub band3-2

Sub screen1-10

T

Time Set (Set mode)8-17

Tone Control/TBW (Set mode)8-2

Transmit output power3-10

Troubleshooting10-2

Tuning Step function3-5

U

USB flash drive6-1

USB Flash Drive (Set mode)8-18

V

VFO mode3-1

Volume level3-1

ABOUT THE LICENSES

Information on the open source software being used by this product.

COPYRIGHT NOTICE, DISCLAIMER, and LICENSE:

If you modify libpng you may insert additional notices immediately following this sentence.

This code is released under the libpng license.

libpng versions 1.2.6, August 15, 2004, through 1.6.12, June 12, 2014, are Copyright (c) 2004, 2006-2014 Glenn Randers-Pehrson, and are distributed according to the same disclaimer and license as libpng-1.2.5 with the following individual added to the list of Contributing Authors:

Cosmin Truta

libpng versions 1.0.7, July 1, 2000, through 1.2.5, October 3, 2002, are Copyright (c) 2000-2002 Glenn Randers-Pehrson, and are distributed according to the same disclaimer and license as libpng-1.0.6 with the following individuals added to the list of Contributing Authors:

Simon-Pierre Cadieux
Eric S. Raymond
Gilles Vollant

and with the following additions to the disclaimer:

There is no warranty against interference with your enjoyment of the library or against infringement. There is no warranty that our efforts or the library will fulfill any of your particular purposes or needs. This library is provided with all faults, and the entire risk of satisfactory quality, performance, accuracy, and effort is with the user.

libpng versions 0.97, January 1998, through 1.0.6, March 20, 2000, are Copyright (c) 1998, 1999, 2000 Glenn Randers-Pehrson, and are distributed according to the same disclaimer and license as libpng-0.96, with the following individuals added to the list of Contributing Authors:

Tom Lane
Glenn Randers-Pehrson
Willem van Schaik

libpng versions 0.89, June 1996, through 0.96, May 1997, are Copyright (c) 1996, 1997 Andreas Dilger Distributed according to the same disclaimer and license as libpng-0.88, with the following individuals added to the list of Contributing Authors:

John Bowler
Kevin Bracey
Sam Bushell
Magnus Holmgren
Greg Roelofs
Tom Tanner

libpng versions 0.5, May 1995, through 0.88, January 1996, are Copyright (c) 1995, 1996 Guy Eric Schalnat, Group 42, Inc.

For the purposes of this copyright and license, "Contributing Authors" is defined as the following set of individuals:

Andreas Dilger
Dave Martindale
Guy Eric Schalnat
Paul Schmidt
Tim Wegner

The PNG Reference Library is supplied "AS IS". The Contributing Authors and Group 42, Inc. disclaim all warranties, expressed or implied, including, without limitation, the warranties of merchantability and of fitness for any purpose. The Contributing Authors and Group 42, Inc. assume no liability for direct, indirect, incidental, special, exemplary, or consequential damages, which may result from the use of the PNG Reference Library, even if advised of the possibility of such damage.

Permission is hereby granted to use, copy, modify, and distribute this source code, or portions hereof, for any purpose, without fee, subject to the following restrictions:

1. The origin of this source code must not be misrepresented.
2. Altered versions must be plainly marked as such and must not be misrepresented as being the original source.
3. This Copyright notice may not be removed or altered from any source or altered source distribution.

The Contributing Authors and Group 42, Inc. specifically permit, without fee, and encourage the use of this source code as a component to supporting the PNG file format in commercial products. If you use this source code in a product, acknowledgment is not required but would be appreciated.

A "png_get_copyright" function is available, for convenient use in "about" boxes and the like:

```
printf("%s", png_get_copyright(NULL));
```

Also, the PNG logo (in PNG format, of course) is supplied in the files "pngbar.png" and "pngbar.jpg (88x31)" and "pngnow.png" (98x31).

Libpng is OSI Certified Open Source Software. OSI Certified is a certification mark of the Open Source Initiative.

The contributing authors would like to thank all those who helped with testing, bug fixes, and patience. This wouldn't have been possible without all of you.

Thanks to Frank J. T. Wojcik for helping with the documentation.

License for CMSIS-RTOS RTX Implementation

Copyright (c) 1999-2009 KEIL, 2009-2013 ARM Germany GmbH All rights reserved.

Redistribution and use in source and binary forms, with or without modification, are permitted provided that the following conditions are met:

- Redistributions of source code must retain the above copyright notice, this list of conditions and the following disclaimer.
- Redistributions in binary form must reproduce the above copyright notice, this list of conditions and the following disclaimer in the documentation and/or other materials provided with the distribution.
- Neither the name of ARM nor the names of its contributors may be used to endorse or promote products derived from this software without specific prior written permission.

THIS SOFTWARE IS PROVIDED BY THE COPYRIGHT HOLDERS AND CONTRIBUTORS "AS IS" AND ANY EXPRESS OR IMPLIED WARRANTIES, INCLUDING, BUT NOT LIMITED TO, THE IMPLIED WARRANTIES OF MERCHANTABILITY AND FITNESS FOR A PARTICULAR PURPOSE ARE DISCLAIMED. IN NO EVENT SHALL COPYRIGHT HOLDERS AND CONTRIBUTORS BE LIABLE FOR ANY DIRECT, INDIRECT, INCIDENTAL, SPECIAL, EXEMPLARY, OR CONSEQUENTIAL DAMAGES (INCLUDING, BUT NOT LIMITED TO, PROCUREMENT OF SUBSTITUTE GOODS OR SERVICES; LOSS OF USE, DATA, OR PROFITS; OR BUSINESS

INTERRUPTION) HOWEVER CAUSED AND ON ANY THEORY OF LIABILITY, WHETHER IN CONTRACT, STRICT LIABILITY, OR TORT (INCLUDING NEGLIGENCE OR OTHERWISE) ARISING IN ANY WAY OUT OF THE USE OF THIS SOFTWARE, EVEN IF ADVISED OF THE POSSIBILITY OF SUCH DAMAGE.

ZLIB DATA COMPRESSION LIBRARY

zlib 1.2.8 is a general purpose data compression library. All the code is thread safe. The data format used by the zlib library is described by RFCs (Request for Comments) 1950 to 1952 in the files <http://tools.ietf.org/html/rfc1950> (zlib format), [rfc1951](http://tools.ietf.org/html/rfc1951) (deflate format) and [rfc1952](http://tools.ietf.org/html/rfc1952) (gzip format).

All functions of the compression library are documented in the file `zlib.h` (volunteer to write man pages welcome, contact zlib@gzip.org). A usage example of the library is given in the file `test/example.c` which also tests that the library is working correctly. Another example is given in the file `test/minigzip.c`. The compression library itself is composed of all source files in the root directory.

To compile all files and run the test program, follow the instructions given at the top of `Makefile.in`. In short ".`/configure`; `make test`", and if that goes well, "make install" should work for most flavors of Unix. For Windows, use one of the special makefiles in `win32/` or `contrib/vstudio/`. For VMS, use `make_vms.com`.

Questions about zlib should be sent to zlib@gzip.org, or to Gilles Vollant info@winimage.com for the Windows DLL version. The zlib home page is <http://zlib.net/>. Before reporting a problem, please check this site to verify that you have the latest version of zlib; otherwise get the latest version and check whether the problem still exists or not.

PLEASE read the zlib FAQ http://zlib.net/zlib_faq.html before asking for help.

Mark Nelson markn@ieee.org wrote an article about zlib for the Jan. 1997 issue of Dr. Dobbs's Journal; a copy of the article is available at <http://marknelson.us/1997/01/01/zlib-engine/>.

The changes made in version 1.2.8 are documented in the file `ChangeLog`.

Unsupported third party contributions are provided in directory `contrib/`.

zlib is available in Java using the `java.util.zip` package, documented at <http://java.sun.com/developer/technicalArticles/Programming/compression/>.

A Perl interface to zlib written by Paul Marquess pmqs@cpan.org is available at CPAN (Comprehensive Perl Archive Network) sites, including <http://search.cpan.org/~pmqs/IO-Compress-Zlib/>.

A Python interface to zlib written by A.M.Kuchling amk@amk.ca is available in Python 1.5 and later versions, see <http://docs.python.org/library/zlib.html>.

zlib is built into tcl: <http://wiki.tcl.tk/4610>.

An experimental package to read and write files in `.zip` format, written on top of zlib by Gilles Vollant info@winimage.com, is available in the `contrib/minizip` directory of zlib.

Notes for some targets:

- For Windows DLL versions, please see `win32/DLL_FAQ.txt`
- For 64-bit Irix, `deflate.c` must be compiled without any optimization. With `-O`, one libpng test fails. The test works in 32 bit

mode (with the `-n32` compiler flag). The compiler bug has been reported to SGI.

- zlib doesn't work with gcc 2.6.3 on a DEC 3000/300LX under OSF/1 2.1 it works when compiled with cc.

- On Digital Unix 4.0D (formerly OSF/1) on AlphaServer, the `cc` option `-std1` is necessary to get `gzprintf` working correctly. This is done by `configure`.

- zlib doesn't work on HP-UX 9.05 with some versions of `/bin/cc`. It works with other compilers. Use "make test" to check your compiler.

- `gzopen` is not supported on RISCOS or BEOS.

- For PalmOS, see <http://palmzlib.sourceforge.net/>

Acknowledgments:

The deflate format used by zlib was defined by Phil Katz. The deflate and zlib specifications were written by L. Peter Deutsch. Thanks to all the people who reported problems and suggested various improvements in zlib; they are too numerous to cite here.

Copyright notice:

(C) 1995-2013 Jean-loup Gailly and Mark Adler

This software is provided 'as-is', without any express or implied warranty. In no event will the authors be held liable for any damages arising from the use of this software.

Permission is granted to anyone to use this software for any purpose, including commercial applications, and to alter it and redistribute it freely, subject to the following restrictions:

1. The origin of this software must not be misrepresented; you must not claim that you wrote the original software. If you use this software in a product, an acknowledgment in the product documentation would be appreciated but is not required.
2. Altered source versions must be plainly marked as such, and must not be misrepresented as being the original software.
3. This notice may not be removed or altered from any source distribution.

Jean-loup Gailly Mark Adler
jloop@gzip.org madler@alumni.caltech.edu

If you use the zlib library in a product, we would appreciate "not" receiving lengthy legal documents to sign. The sources are provided for free but without warranty of any kind. The library has been entirely written by Jean-loup Gailly and Mark Adler; it does not include third-party code.

If you redistribute modified sources, we would appreciate that you include in the file `ChangeLog` history information documenting your changes. Please read the FAQ for more information on the distribution of modified source versions.

mbed TLS

Apache License

Version 2.0, January 2004

<http://www.apache.org/licenses/>

TERMS AND CONDITIONS FOR USE, REPRODUCTION, AND DISTRIBUTION

1. Definitions.

"License" shall mean the terms and conditions for use, reproduction, and distribution as defined by Sections 1 through 9 of this document.

"Licensor" shall mean the copyright owner or entity authorized by the copyright owner that is granting the License.

"Legal Entity" shall mean the union of the acting entity and all other entities that control, are controlled by, or are under common control with that entity. For the purposes of this definition, "control" means (i) the power, direct or indirect, to cause the direction or management of such entity, whether by contract or otherwise, or (ii) ownership of fifty percent (50%) or more of the outstanding shares, or (iii) beneficial ownership of such entity.

"You" (or "Your") shall mean an individual or Legal Entity exercising permissions granted by this License.

"Source" form shall mean the preferred form for making modifications, including but not limited to software source code, documentation source, and configuration files.

"Object" form shall mean any form resulting from mechanical transformation or translation of a Source form, including but not limited to compiled object code, generated documentation, and conversions to other media types.

"Work" shall mean the work of authorship, whether in Source or Object form, made available under the License, as indicated by a copyright notice that is included in or attached to the work (an example is provided in the Appendix below).

"Derivative Works" shall mean any work, whether in Source or Object form, that is based on (or derived from) the Work and for which the editorial revisions, annotations, elaborations, or other modifications represent, as a whole, an original work of authorship. For the purposes of this License, Derivative Works shall not include works that remain separable from, or merely link (or bind by name) to the interfaces of, the Work and Derivative Works thereof.

"Contribution" shall mean any work of authorship, including the original version of the Work and any modifications or additions to that Work or Derivative Works thereof, that is intentionally submitted to Licensor for inclusion in the Work by the copyright owner or by an individual or Legal Entity authorized to submit on behalf of the copyright owner. For the purposes of this definition, "submitted" means any form of electronic, verbal, or written communication sent to the Licensor or its

representatives, including but not limited to communication on electronic mailing lists, source code control systems, and issue tracking systems that are managed by, or on behalf of, the Licensor for the purpose of discussing and improving the Work, but excluding communication that is conspicuously marked or otherwise designated in writing by the copyright owner as "Not a Contribution."

"Contributor" shall mean Licensor and any individual or Legal Entity on behalf of whom a Contribution has been received by Licensor and subsequently incorporated within the Work.

2. Grant of Copyright License. Subject to the terms and conditions of this License, each Contributor hereby grants to You a perpetual, worldwide, non-exclusive, no-charge, royalty-free, irrevocable copyright license to reproduce, prepare Derivative Works of, publicly display, publicly perform, sublicense, and distribute the Work and such Derivative Works in Source or Object form.
3. Grant of Patent License. Subject to the terms and conditions of this License, each Contributor hereby grants to You a perpetual, worldwide, non-exclusive, no-charge, royalty-free, irrevocable (except as stated in this section) patent license to make, have made, use, offer to sell, sell, import, and otherwise transfer the Work, where such license applies only to those patent claims licensable by such Contributor that are necessarily infringed by their Contribution(s) alone or by combination of their Contribution(s) with the Work to which such Contribution(s) was submitted. If You institute patent litigation against any entity (including a cross-claim or counterclaim in a lawsuit) alleging that the Work or a Contribution incorporated within the Work constitutes direct or contributory patent infringement, then any patent licenses granted to You under this License for that Work shall terminate as of the date such litigation is filed.
4. Redistribution. You may reproduce and distribute copies of the Work or Derivative Works thereof in any medium, with or without modifications, and in Source or Object form, provided that You meet the following conditions:
 - (a) You must give any other recipients of the Work or Derivative Works a copy of this License; and
 - (b) You must cause any modified files to carry prominent notices stating that You changed the files; and
 - (c) You must retain, in the Source form of any Derivative Works that You distribute, all copyright, patent, trademark, and attribution notices from the Source form of the Work, excluding those notices that do not pertain to any part of the Derivative Works; and
 - (d) If the Work includes a "NOTICE" text file as part of its distribution, then any Derivative Works that You distribute must include a readable copy of the attribution notices contained within such NOTICE file, excluding those notices that do not pertain to any part of the Derivative Works, in at least one of the following places: within a

NOTICE text file distributed as part of the Derivative Works; within the Source form or documentation, if provided along with the Derivative Works; or, within a display generated by the Derivative Works, if and wherever such third-party notices normally appear. The contents of the NOTICE file are for informational purposes only and do not modify the License. You may add Your own attribution notices within Derivative Works that You distribute, alongside or as an addendum to the NOTICE text from the Work, provided that such additional attribution notices cannot be construed as modifying the License.

You may add Your own copyright statement to Your modifications and may provide additional or different license terms and conditions for use, reproduction, or distribution of Your modifications, or for any such Derivative Works as a whole, provided Your use, reproduction, and distribution of the Work otherwise complies with the conditions stated in this License.

5. Submission of Contributions. Unless You explicitly state otherwise, any Contribution intentionally submitted for inclusion in the Work by You to the Licensor shall be under the terms and conditions of this License, without any additional terms or conditions. Notwithstanding the above, nothing herein shall supersede or modify the terms of any separate license agreement you may have executed with Licensor regarding such Contributions.
6. Trademarks. This License does not grant permission to use the trade names, trademarks, service marks, or product names of the Licensor, except as required for reasonable and customary use in describing the origin of the Work and reproducing the content of the NOTICE file.
7. Disclaimer of Warranty. Unless required by applicable law or agreed to in writing, Licensor provides the Work (and each Contributor provides its Contributions) on an "AS IS" BASIS, WITHOUT WARRANTIES OR CONDITIONS OF ANY KIND, either express or implied, including, without limitation, any warranties or conditions of TITLE, NON-INFRINGEMENT, MERCHANTABILITY, or FITNESS FOR A PARTICULAR PURPOSE. You are solely responsible for determining the appropriateness of using or redistributing the Work and assume any risks associated with Your exercise of permissions under this License.
8. Limitation of Liability. In no event and under no legal theory, whether in tort (including negligence), contract, or otherwise, unless required by applicable law (such as deliberate and grossly negligent acts) or agreed to in writing, shall any Contributor be liable to You for damages, including any direct, indirect, special, incidental, or consequential damages of any character arising as a result of this License or out of the use or inability to use the Work (including but not limited to damages for loss of goodwill, work stoppage, computer failure or malfunction, or any and all other commercial damages or

losses), even if such Contributor has been advised of the possibility of such damages.

9. Accepting Warranty or Additional Liability. While redistributing the Work or Derivative Works thereof, You may choose to offer, and charge a fee for, acceptance of support, warranty, indemnity, or other liability obligations and/or rights consistent with this License. However, in accepting such obligations, You may act only on Your own behalf and on Your sole responsibility, not on behalf of any other Contributor, and only if You agree to indemnify, defend, and hold each Contributor harmless for any liability incurred by, or claims asserted against, such Contributor by reason of your accepting any such warranty or additional liability.

END OF TERMS AND CONDITIONS

APPENDIX: How to apply the Apache License to your work.

To apply the Apache License to your work, attach the following boilerplate notice, with the fields enclosed by brackets "[]" replaced with your own identifying information. (Don't include the brackets!) The text should be enclosed in the appropriate comment syntax for the file format. We also recommend that a file or class name and description of purpose be included on the same "printed page" as the copyright notice for easier identification within third-party archives.

Copyright 2016, Arthur Teplitzki 2013, Edmodo, Inc.

Licensed under the Apache License, Version 2.0 (the "License");

you may not use this file except in compliance with the License.

You may obtain a copy of the License at

<http://www.apache.org/licenses/LICENSE-2.0>

Unless required by applicable law or agreed to in writing, software distributed under the License is distributed on an "AS IS" BASIS, WITHOUT WARRANTIES OR CONDITIONS OF ANY KIND, either express or implied.

See the License for the specific language governing permissions and limitations under the License.

